

 Lockheed

VOL. 18, NO. 2 APRIL-JUNE 1991

# ***SERVICE NEWS***

A Service Publication of Lockheed Aeronautical Systems Company



***Engine Run Safety***

A SERVICE PUBLICATION OF  
LOCKHEED AERONAUTICAL  
SYSTEMS COMPANY

Editor  
Charles I. Gale

Art Director  
Anne G. Anderson

Vol. 18, No. 2, April - June 1991

**CONTENTS**

- 2 Focal Point  
Bob Aycock, Manager,  
Product Support  
Star Quality Program
- 3 Engine Run Safety  
A practical guide to safe  
engine maintenance runs.
- 7 Identifying GTC and APU  
starters  
They may look similar, but these  
starters are not interchangeable.
- 8 Eliminating NLG Fulcrum  
Bearing Noise  
A relatively simple repair can often  
eliminate NLG taxi noises.
- 10 A New MLG Emergency Tiedown  
Fixture  
This new fixture offers sturdy  
support in MLG emergencies.
- 13 Flap Jackscrew Interchange-  
ability  
A handy guide for determining  
functional equivalencies in  
flap drive components.

Photographic Support: John Rossino

Cover: Lockheed Aeromod Center and Foster Edwards Aircraft converted this Hercules airfreighter to a comfortable, up-to-date, passenger configuration for Merpati Airlines.

Service News is published by Lockheed Aeronautical Systems Company, a unit of Lockheed Corporation. Information contained in this issue is considered by Lockheed to be accurate and authoritative, it should not be assumed, however, that this material has received approval from any governmental agency or military service unless it is specifically noted. This publication is for planning and information purposes only, and it is not to be construed as authority for making changes on aircraft or equipment, or as superseding any established operational or maintenance procedures or policies. The following marks are registered and owned by Lockheed Corporation:  "Hercules," and "JetStar." Written permission must be obtained from Lockheed Aeronautical Systems Company before republishing any material in this periodical. Address all communications to Editor, Service News, Department 66-H, Zone 0308, Lockheed Aeronautical Systems Company, Marietta, Georgia 30063. Copyright 1991 Lockheed Corporation.

**Focal Point**



Bob Aycock

**TOM in Product Support**

The era of TQM-Total Quality Management-has begun, and the results have had a significant impact on our way of doing business and on the expectations of our customers.

The concept of TQM originated in the U.S., but manifested itself most strikingly in the business culture of Japan. The products of Japan have earned the most convincing confirmation of product success: customer satisfaction. That success story needs no further description, but it contains a lesson that can be applied anywhere. The Japanese experience shows the immense an energetic program dedicated to implementing the principles of TQM across a broad spectrum of industrial enterprises. It also demonstrates the dramatic way in which TQM can enhance a manufacturer's ability to meet the requirements of his customers.

At LASC, we are fully committed to every facet of the TQM concept. We call our TQM program "Star Quality," and we take our program goals seriously. In Product Support, we have dedicated ourselves to achieving a very specific objective: improving our approach to customer service such that the customer's expectations will not just be met; they will be exceeded.

How are we setting about to accomplish this? To begin with, we are focusing on the basics. We are using TQM's proven methodologies to identify cost drivers and eliminate inefficiencies wherever they may be found in the Product Support equation. Every day, in every activity we undertake, policies and processes are being put to the test. Continuous improvement, one of TOM's most important principles, has become a way of life.

But this endeavor can only succeed if dedication and resolve are supported by the skills needed to bridge the gap between the ideal and the real. LASC employees are being trained to utilize new tools-statistical process controls, for example-to improve our systems and strategies. Our supervisors and managers are actively seeking guidelines from the task performers themselves in formal, problem-solving Process Action Teams. Increasing employee involvement leads to a strengthening of capabilities at the point where the work is actually being done. It is one of the surest ways of achieving fundamental improvement in the total quality of products and services.

These efforts are already paying off in Product Support and throughout LASC. An indication of how well we are progressing is the Contractor Blue Ribbon awards that we have received from the Warner Robins, San Antonio, and Ogden Air Logistics Centers. We take special pride in these achievements, but we know that it is just a beginning. Our commitment to TQM through our Star Quality program is permanent and open-ended. It is part of a solemn pledge that our world-class customers will always receive the world-class support they deserve.

Sincerely,  

Robert E. Aycock, Manager  
Product Support Star Quality Program

**PRODUCT SUPPORT** LOCKHEED AERONAUTICAL SYSTEMS COMPANY

**H. L. BURNETTE DIRECTOR**

FIELD SUPPORT	SUPPLY SUPPORT	TECHNICAL PUBLICATIONS	RM&S DESIGN	CUSTOMER TRAINING
J. D. Adams	J. L. Bailey	A. G. Hunt	H. D. Hall	S. S. Clark

# Engine Run Safety

by R. M. Guidice, Senior Engineer  
Product and System Safety Engineering Department

A C-130 rolls over its chocks and continues on for 300 yards before hitting a hangar. Another Hercules jumps its chocks, runs into a power cart, veers off the ramp, and hits a tree. In a third incident, a C-130 jumps its chocks and hits another C-130. A tire breaks out, and both aircraft are burned beyond repair. The scenarios may sound improbable, but these and a number of similar events have all happened during a familiar and unremarkable activity: the maintenance engine run.

The post-maintenance engine run is basically a routine procedure. It is performed safely literally hundreds of times per week throughout the Hercules fleet, all over the world. Unfortunately, there are also times when critical points of safe procedure are forgotten, overlooked, or otherwise left out of the process. Too many Hercules aircraft have collided with obstructions or each other, and have been damaged beyond economical repair after their engine-run crews lost control. Among major Hercules ground mishaps on record, the engine run is the most common scenario.

## Weighing the Cause Factors

Investigation of these mishaps has revealed some common threads or cause factors that emerge repeatedly in cases of engine runup incidents. Typically, they involve:

- Failure to follow established procedures.
- Inadequate system knowledge.
- Insufficient training.

Let us examine these cause factors more closely and see what kinds of preventive remedies can be offered.

The first cause factor is most often manifested when the crew does not follow the “before starting engines” checklist properly. What happens next is that the auxiliary hydraulic pump switch may not be turned on with emergency brakes selected, or the brake selector



This aircraft was damaged beyond repair as the result of an engine-run accident. Inadequate training is the single most important cause of such mishaps.

switch may be left in the normal position. This results in the engines being started with no main landing gear brake pressure available.

The second cause factor is evidenced by two very common misconceptions. The first misconception is that once set, the parking brake will hold the aircraft for an indefinite period of time, even without the aircraft hydraulic system being pressurized. This, of course, is untrue. When the parking brake is set and the aircraft hydraulic systems are shut down, the brake pressure slowly bleeds off through the system return lines. Within two hours, the parking brake will no longer be effective.

Failure to understand this point has led some crews to set the parking brake and then turn off the auxiliary pump with emergency brakes selected, only to have the aircraft jump the chocks at a later time when a high power setting was applied.

The other common misconception is that chocks will hold the aircraft under power. This is also not true. Chocks were designed to prevent an aircraft from rolling out of its parked position when the aircraft is completely shut down. Only the brakes can hold the aircraft with engine power applied.

The third cause factor is inadequate training. That inadequate training is at the heart of many engine-run mishaps is almost painfully obvious. Investigations have revealed that when faced with sudden, unexpected movement of the aircraft, the engine-run crew often simply did not know what to do. Although there was no malfunction of any aircraft system, a disastrous collision with another solid object usually resulted. Thorough

training will prevent most of these types of problems from developing.

### Up, Over, and Away

It is worth noting that the forces attempting to move the aircraft during an engine runup are quite significant. One is wing lift. Fifty-four feet, or 41% of the total wing span, is swept by the diameter of the propellers. The wind blast generated by the props supplies a large amount of lift with this much wing area affected. This

The wing of this airlifter sustained severe damage when it stuck a hangar after the engine-run crew lost control.



force is trying to lift the aircraft up and over the chocks. This tendency is even more acute at lighter gross weights, and relatively light gross weights are normally the case during a ground runup.

Another is thrust. Under standard-day conditions, each T56-A-15 engine and 54H60 prop produce approximately 9,650 pounds of static thrust at full takeoff power. With all four engines running, this amounts to 38,600 pounds of thrust acting on the aircraft. This combination of thrust and lift can easily cause the aircraft to climb up and over ordinary chocks if the brakes are not applied. Under these conditions, the airplane will also accelerate at a rate that can startle anyone not accustomed to the takeoff performance of the Hercules. It is for these reasons that Lockheed recommends that engines be run to full power only in symmetrical pairs during maintenance checks.

### Mishap Prevention

There are two areas in which any operator can make significant strides in ground mishap prevention. The first is clearly in the area of training.

The engine-run crew is just as important as the flight crew when it comes to training, for it is the same multi-million dollar asset that is entrusted to both. The instruction both receive should be commensurate with that responsibility.

Some guidelines to follow when setting up an engine run training program are:

- The training should include all normal and emergency procedures involved with ground operations of the aircraft.

- With a qualified pilot on board, the trainee should practice taxiing the aircraft, using the brakes, and reversing the propellers.

- The trainee should experience the acceleration rate accompanying a normal takeoff roll.

The training program itself should include the following procedures:

- Locating the aircraft in an engine runup area clear of obstacles. (The illustration at the bottom of this page and the text on page 6 provide more detailed information on this).
- Briefing the crew on emergency procedures, including those actions to be taken should the aircraft jump the chocks.
- Following all normal checklists appropriate for the applicable model of Hercules.
- Ensuring that qualified personnel occupy both pilot seats.
- Ensuring that all engine-run crew members in the flight station are wearing seat belts, and have seats adjusted so that maximum brake pedal deflection can be achieved.
- Verifying that proper brake pressure is available with the auxiliary system pump turned on prior to setting the parking brake.
- Ensuring that the auxiliary hydraulic pump is on with emergency brakes selected, from before engine start until after engine shutdown.

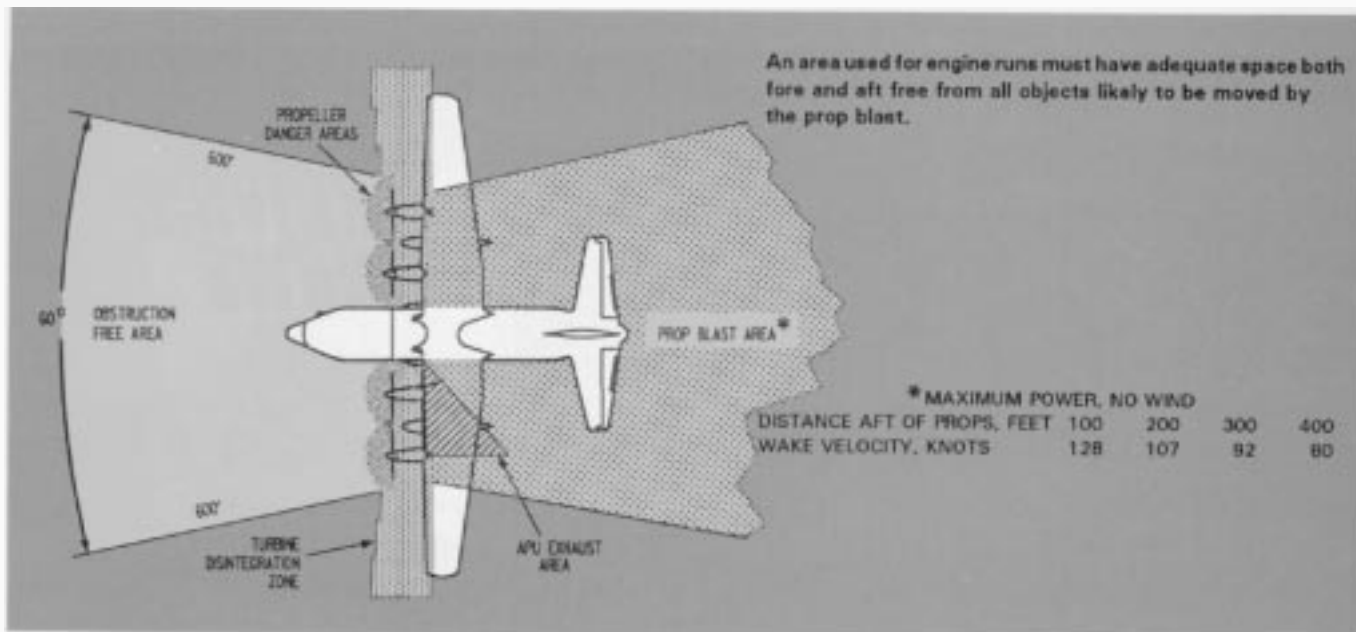

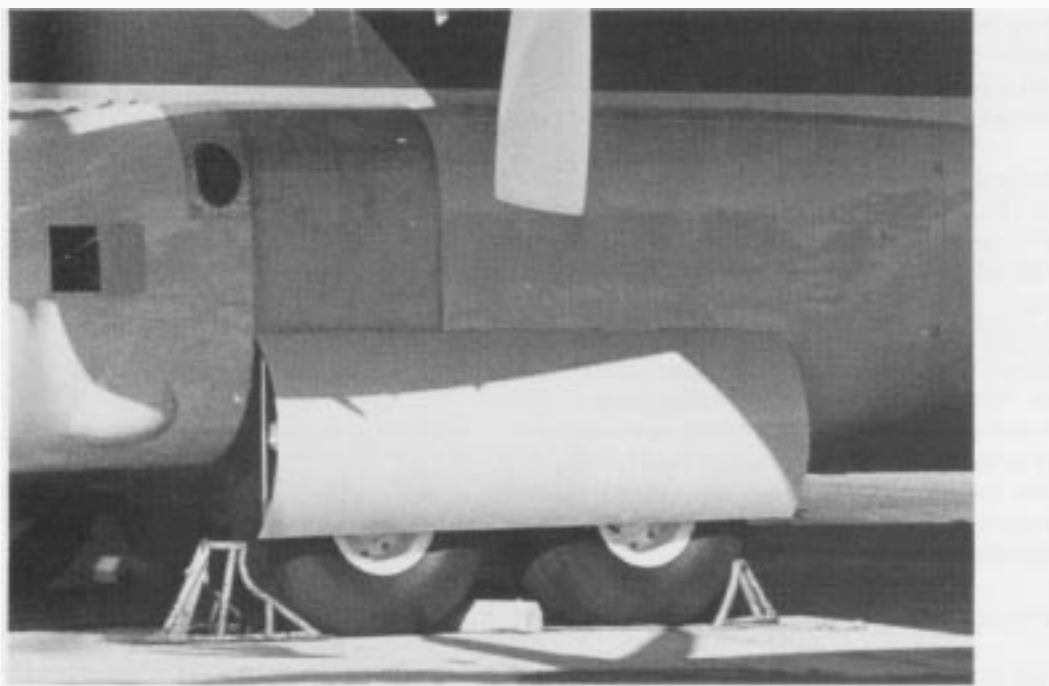

Properly designed, cage-type chocks can go a long way toward preventing “jumped chocks” incidents.

---

### Upgrading Facilities

As important as training is, operators also should not neglect the importance of proper physical facilities in the prevention of engine-run mishaps. Aircraft should be parked for engine runs in an area that has either blast deflectors or adequate space aft of the aircraft free of all objects likely to be moved by the propeller blast. This area is defined in the applicable Hercules operations handbook. Even more important is an obstruction-free area in front of the aircraft that is defined by a 60-degree cone with sides 600 feet in length.

Sometimes innovative approaches will prevent the development of potentially dangerous situations. When C-130 production began at Lockheed’s facility in Marietta, Georgia, it became obvious that some unusual

protective measures would be necessary to prevent “jumped chocks” incidents. Ramp space arrangements made it necessary to run engines on aircraft that are parked approximately 300 feet from and facing toward hangars.

To prevent mishaps, a unique chocking system was devised. It consists of very large, cage-type chocks which pin into steel plates anchored to foundation blocks in the ramp (see photo above). Aircraft cannot roll up and over these chocks. Once the main landing gear tires are up against them, the aircraft is completely secure.

Sound knowledge of aircraft systems and adherence to well thought-out procedures will allow safe ground engine run operations and help ensure the protection of costly airlift assets.





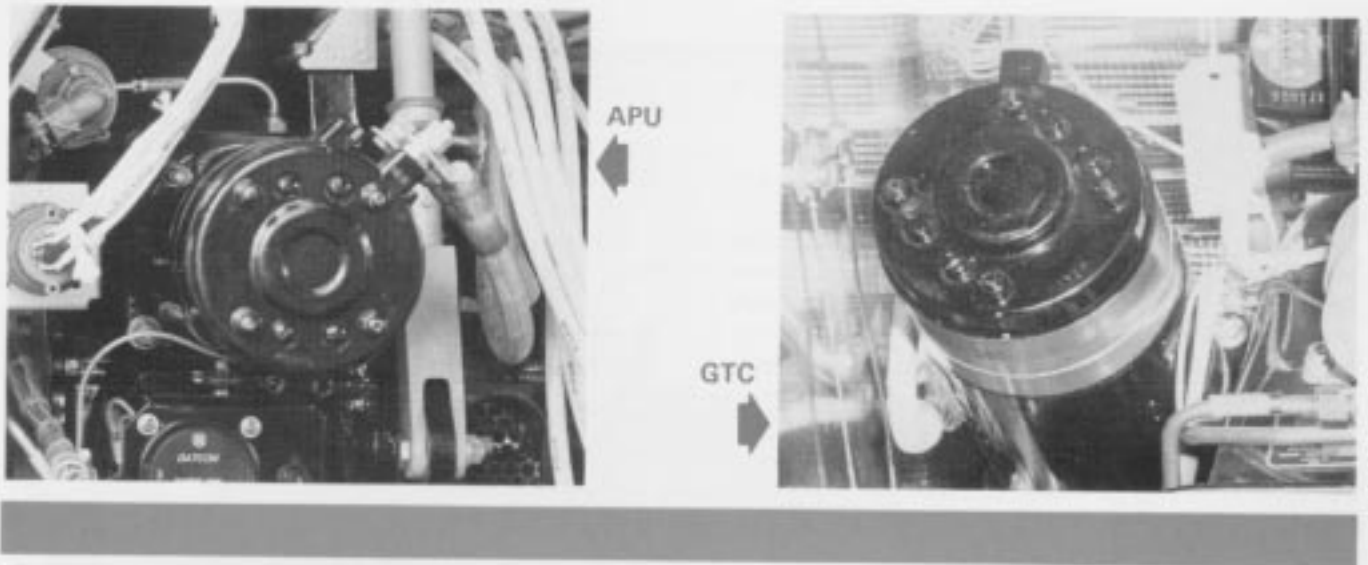

## Identifying APU and GTC Starters

by Darel A. Traylor, Service Analyst Coordinator  
Airlift Field Service Department

Historically, there has been some difficulty in distinguishing between APU and GTC starters for the various models of Hercules aircraft. This has been of particular concern in fleets where some aircraft are equipped with APUs and others with GTCs. The starters for the APU and the GTC are nearly identical in appearance (see photos above), and it is physically possible to install either starter on either unit. Confusing the two types could lead to a real problem, however, because the starters rotate in opposite directions. Installation of the wrong starter could damage the starter and possibly the starter input shaft.

There are several ways to tell which is the correct starter installation. The most obvious is the part num-

bers. Part number 372697-1 8-1 starters are used on the PN381116-1-7 APU, and PN3605812-18-1 starters for the PN 381116-1-S APU. On the GTC, use part number 375322-4, -6, or -9 starters, as applicable.

A close visual inspection of the clutch ratchet on the starter will indicate the direction of rotation, but an easier way to determine the direction of rotation is to examine the starter end cap and note the position of the brush rigging screws relative to the ground terminal. As shown in the accompanying figure, there is a 90-degree difference in the alignment of the brush rigging screws on the two different starters. Careful attention to these details will help preclude damage to the units and ensure smooth maintenance operations.

The position of the brush rigging screws relative to the ground terminal is a useful key to identification

TRAYLOR

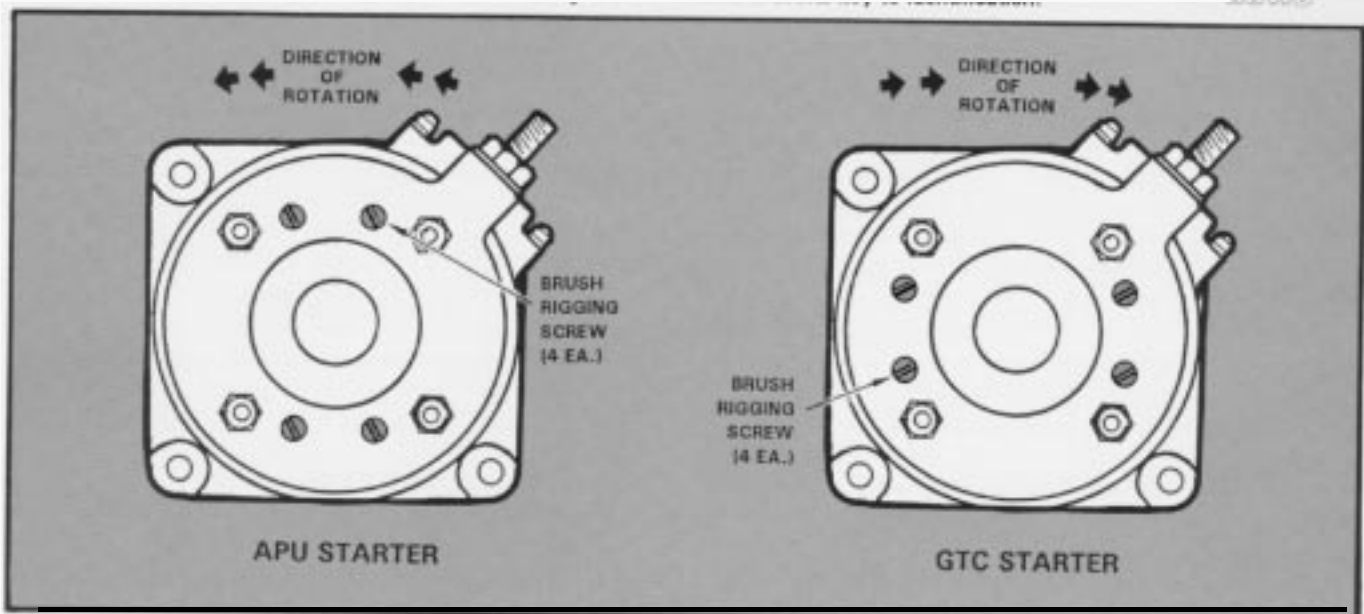



USAF photo by TSgt L. E. Lewis Jr.

## **ELIMINATING NLG FULCRUM BEARING NOISE**

by W. F. Starkey, *Customer Supply Liaison Representative*  
*Supply Sales and Contracts Department*

Hercules operators occasionally report hearing grinding or popping noises coming from the vicinity of the NLG wheel well of certain aircraft during taxi. These noises can be annoying, and their origin is often difficult to track down. Random mechanical sounds are readily transmitted through the metal structure of the fuselage, and the ambient noise level makes pinpointing the exact location difficult.

Troubleshooting NLG taxiing noises can turn out to be a time-consuming and exasperating affair, and frustration sometimes leads to overreaction. In one case, an operator removed and replaced an entire NLG assembly to get rid of grinding noises that were originating in the forward part of his airplane during taxi. The strategy worked, but such a drastic-and costly-expedient is usually unnecessary.

An aircraft that is written up for unusual NLG noises during taxi should first be systematically checked to eliminate all the more obvious candidates for noise generation. These would include such items as loose bolts, worn wheel bearings, tire or wheel imbalance, and uneven tire pressures. After all of these possibilities have been ruled out, another potential cause should be considered.

Grinding or popping sounds from the nose wheel well during taxi may indicate the presence of wear in the PN YTA106A fulcrum anti-friction bearings. These bearings have a number of critical functions to perform. They must support the weight of the nose of the aircraft during landings and operations on the ground, and they must also operate smoothly during extension and retraction of the NLG strut.



In addition to the stresses imposed by these important functions, the NLG fulcrum anti-friction bearings are located in an area where they are exposed to a host of abrading and corrosive agents such as sand, salt, dirt, dust, and ice. Over a period of time, these environmental hazards can take a toll. It is no coincidence that the aircraft affected by wear in these areas have usually been in service for a number of years.

To check the condition of the fulcrum anti-friction bearings, disassemble the NLG strut to the extent necessary to gain access to the bearings. Be sure to follow proper procedures as outlined in the maintenance manual applicable to your aircraft. Once the anti-friction bearings have been removed and cleaned, examine them for cracks, corrosion, and wear. The wear will often be

found to be uneven, with much of it concentrated in areas that have been supporting most of the load.

Worn bearings should be replaced. The inner race of new bearings should be lubricated with a film of fresh, general-purpose grease. If the inside diameter of the outer race is Teflon-lined, only the inside diameter of the inner race need be lubricated. The strut should then be reassembled as described in the authorized maintenance instructions. If new bearings are not immediately available, a temporary solution that will usually eliminate the noise is to rotate each bearing 90° and reinstall it. This serves to expose a different area to the load, which ensures a better fit and helps protect the already affected areas from further wear until new bearings can be installed.

**SERVICE NEWS**

Hercules nose landing gear assembly-note PN YTA106A anti-friction bearing.

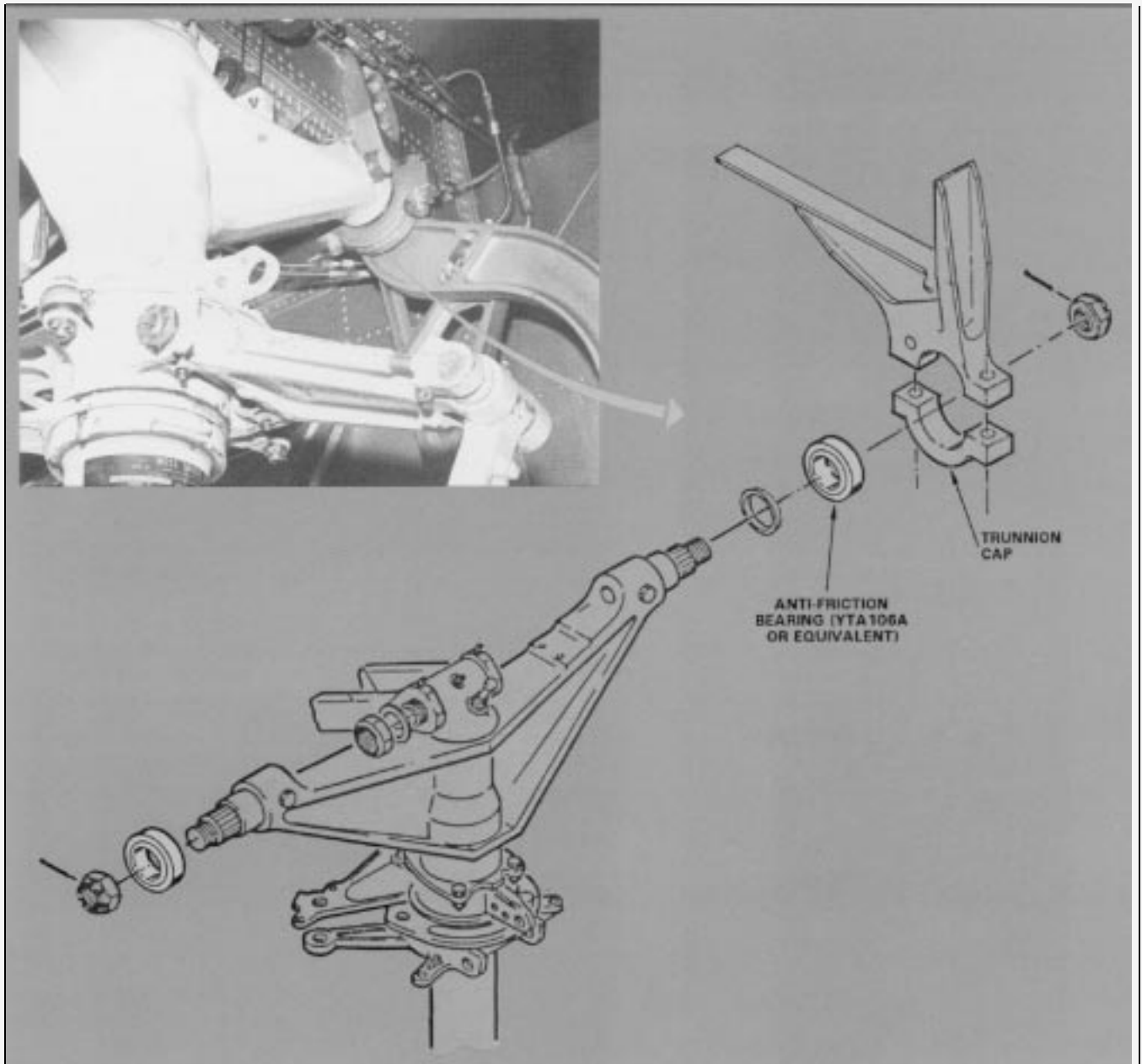

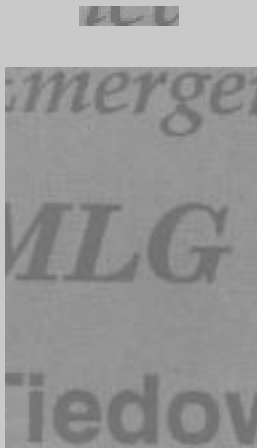

by **Roy H. Webber**, *Staff Engineer*  
*Supportability Technology Department*

Aircrews all over the world know that the main landing gear (MLG) of the Hercules aircraft is a remarkably sturdy and reliable performer. In nearly four decades of service in some of the most difficult operating environments on the planet, the Hercules MLG system has compiled an enviable record of safe and dependable operation. But even the best and most rugged mechanical systems are subject to damage and interference from foreign objects, and the Hercules MLG is no exception to this rule. Occasional damage which complicates lowering the gear does occur.

### **MLG Extension Backup Strategies**

It is for this reason that so many backup strategies are provided for the MLG extension system. They help ensure the continued safe operation of the aircraft in the event of a MLG problem. In many cases where an electrical malfunction prevents the MLG from extending properly, the aircrew can manually actuate the landing gear control valve to restore service. If this tactic is not successful, or hydraulic pressure has been totally lost, the MLG can be extended manually to accomplish a safe landing.

Gear extension problems that arise from mechanical damage or foreign object interference often require a quite different approach. When foreign objects jam critical components or the landing gear is otherwise mechanically disabled, it is not always possible to lower the struts sufficiently to ensure a safe landing by using either the hydraulic or the manual gear extension systems.

In such cases, disconnecting the vertical torque shaft universal joints may allow the gear to free-fall into position. If the gear will not drop far enough using this strategy, the gear can sometimes be lowered the rest of the way by using the emergency extension wrench supplied with the aircraft to rotate the screw jack on each landing gear strut.



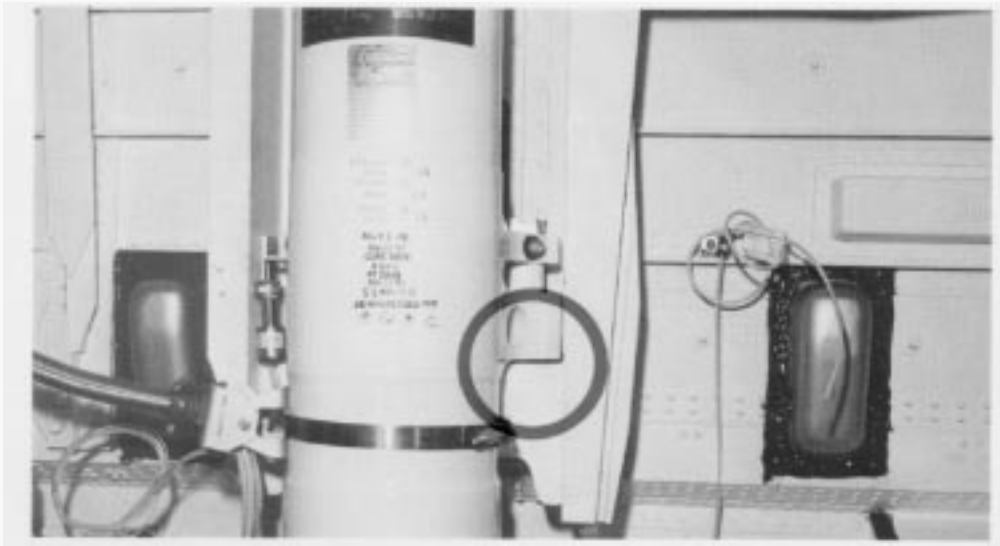

Figure 7. Normal landing configuration: the drag pin has fully engaged the shelf bracket (view looking inboard).

### Securing the Lateral Loads

MLG emergency extension procedures are covered in detail in the authorized flight manuals for the Hercules aircraft, but all have the same basic objective: to lower the gear far enough so that the drag pins will fully engage the shelf bracket. The drag pins react to much of the fore, aft, and side loads of landing and must be in proper position to ensure a secure and stable landing configuration (Figure 1).

If it proves impossible to lower the gear far enough for the drag pins to engage the shelf bracket fully (Figure 2), or in situations where the shelf bracket itself has been damaged, some other method of securing the gear against these loads must be found. Historically in such cases, aircrews have had to thread 10,000- or 25,000-

pound capacity tiedown chains through the lower access panel openings in the wheel wells and tie the landing gear struts on either side of the aircraft firmly together. This serves to hold them against the lateral forces that might otherwise tend to drive the struts outward when side loads are applied during the landing.

Employing tiedown chains for this purpose works satisfactorily when done properly, but there have always been a number of complications associated with their use. For one thing, the chains are bulky and difficult to maneuver through the access panel openings. They must also be linked very tightly to be effective, which can present a safety hazard in case of slippage. Another problem is working room to secure the chains. A loaded cargo compartment is not usually a very convenient place to route several sets of reinforcing chains. In

Figure 2. In this case, the gear has not descended far enough for the drag pin to engage.

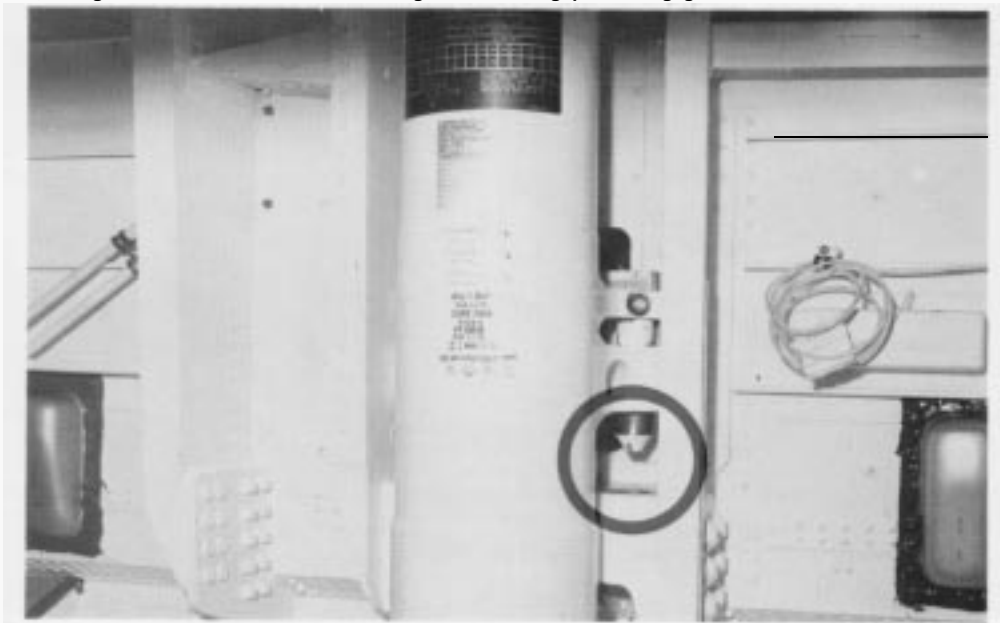

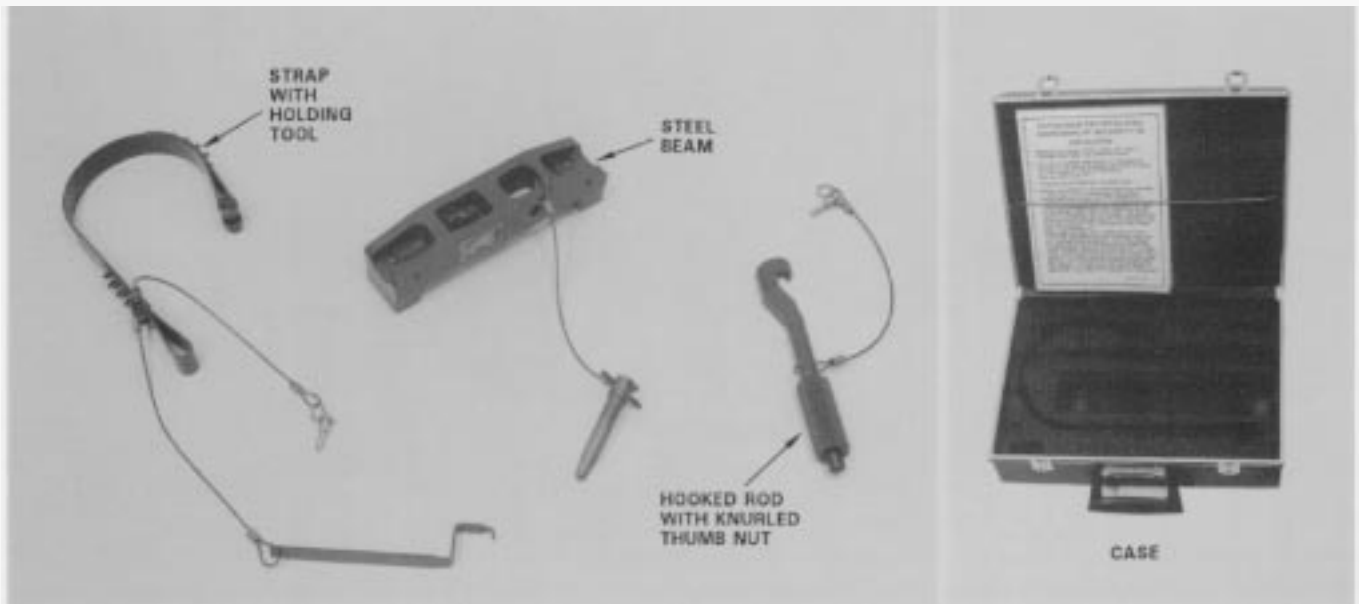

**Figure 3. The MLG Emergency Tiedown Fixture for Hercules aircraft, PN 3402900-1**

normally configured tanker aircraft, with the fuselage tank occupying the middle of the cargo compartment, it is nearly impossible.

#### A Better Alternative

Fortunately, there is now a highly practical alternative to the use of tiedown chains to secure the MLG struts in such situations. It is the MLG Emergency Tiedown Fixture, PN 3402900-1. This unit, which has now been in production for about a year, is designed as a handy, easy-to-use replacement for standard cargo tiedown chains in MLG emergencies. The fixture is much quicker and simpler to install than the chains, particularly when the airplane is fully loaded with cargo,

and comes in a sturdily constructed, compact case that is easy to carry and store (Figure 3).

Equally important, stress analysis has shown that the PN 3402900-1 tiedown fixture is significantly stronger than tiedown chains when used for this purpose, and more effective in securing the gear in position when the drag pins do not extend far enough to engage the shelf brackets.

#### Description and Use

The PN 3402900-1 unit consists of a short alloy steel beam, a hooked rod with a knurled nut, a steel strap with a hook retaining pin, and a holding tool. In use, the pin

**Figure 4. The tiedown fixture strap in position, as seen from the MLG wheel well.**



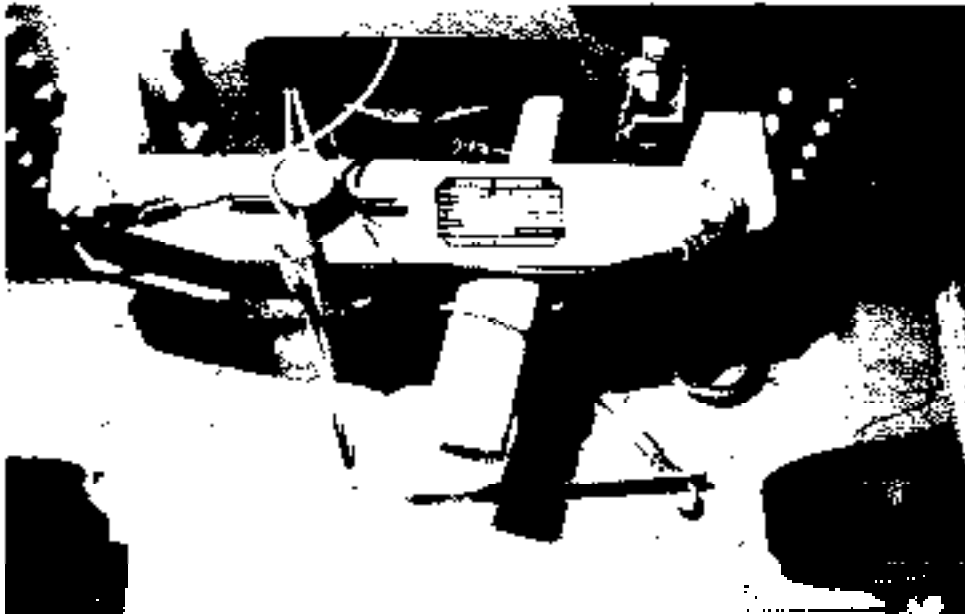

Figure 5. The tiedown fixture's alloy steel beam properly positioned, as seen from the cargo compartment.

end of the strap is inserted through the lower access window and guided around the affected strut with the help of the holding tool (Figure 4). The hooked rod is inserted through the steel beam and can engage the hook retaining pin in the end of the strap when the beam is held positioned at the access window (Figure 5). The knurled cylindrical nut on the hooked rod is used to tighten the strap assembly and rod to the steel beam (Figure 6). Pliers or a pipe wrench can be used on the knurled knob to apply additional tension on the steel strap.

Landings with the MLG Emergency Tiedown Fixture installed require observing the same restrictions that apply when chains are used; these are described in

the flight manual applicable to your aircraft. A normal landing approach should be flown after notifying the control tower of the difficulty and requesting that crash, fire, and rescue equipment be alerted. The minimum sink rate is used prior to touchdown, and the use of brakes should be avoided after contact with the runway. No attempt should be made to turn or taxi the aircraft until the landing gear configuration has been made secure.

The Lockheed MLG Emergency Tiedown Fixture, PN 3402900-1, has been approved for use by Lockheed Engineering. Ordinarily, two of these units should be obtained for each airplane in which they will be used.

For further information concerning the operation of this unit, and for ordering information, please contact: Customer Supply and Business Management, Dept 65-11, Zone 0577, Lockheed-LASC, Marietta, GA 30063; Telephone 404-494-4214; Fax 404-494-7657; Telex 804263 LOC CUST SUPPL.

Figure 6. The PN 3402900-1 tiedown fixture fully installed.

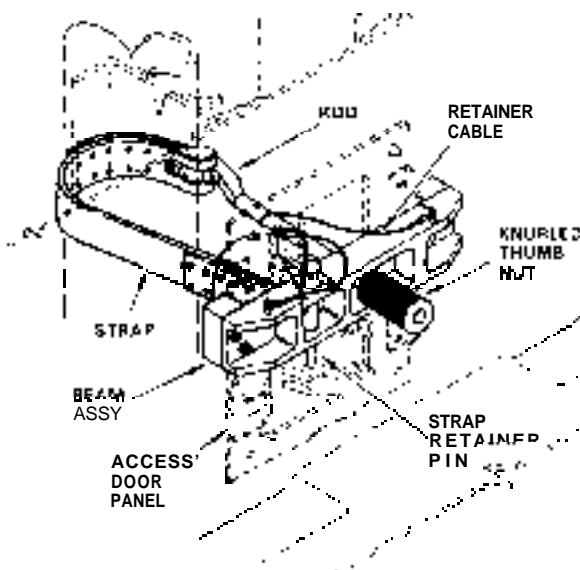

**SERVICE  
NEWS**

# Flap Jackscrew Interchangeability

by Tom Zembik, *Service Analyst*  
Airlift Field Service Department

The wing flaps are vital control surfaces which extend to produce more lift by increasing the wing area and camber. This added lift serves to improve attitude control of the airplane when flying at low speeds. On the Hercules, two outboard and two inboard flap sections are located under the trailing edge of each wing. They are powered by pressure from the utility hydraulic system, which drives a single hydraulic motor. Power travels from the motor via the reduction gearbox, torque tubes, and jackscrews to drive the flaps.

The operation of the jackscrews makes it possible to raise and lower the flaps. These jackscrews work in concert with the 90° gearboxes, connecting links, and ball nuts which move up and down on the jackscrews as the wing flaps are actuated.

With continued use, jackscrews tend to wear on those surfaces where the shaft rotates inside the ball nuts, as well as in the bumper regions. The normal 50% flap takeoff and 100% flap landing settings will also tend to concentrate wear in these areas. Over time, this will necessitate removal of the jackscrews and their replacement with new, compatible units.

Some Hercules operators have a combination of flap drive parts in their inventory and will find it useful to know which of these parts they can interchange. All parts must meet the technical requirements set forth by Lockheed Specification Control Drawing 695676. In particular, all jackscrew assemblies must have an ASA

No. 41 chaincoupling with a 0.50 pitch, 0.306 diameter x 0.25 roller, and a 16-tooth 2.563 pitch diameter sprocket. Differences in appearance are not important. In all flap drive assemblies that are identified as interchangeable, the jackscrews and gearboxes are also interchangeable, regardless of manufacturer.

**With continued use, the flap jackscrews tend to wear on the surfaces where the shaft rotates inside the ball nuts.**





The table below shows a listing of part numbers and vendor cross references which should prove helpful when you need to determine the interchangeability of the wing flap jackscrew assemblies authorized for use on the Hercules aircraft.

**Using the Table**

To use the table, first locate the Lockheed part or vendor part number for the unit you wish to replace in columns 1 through 4. All assemblies listed in the same row are interchangeable.

The table can also be used to find additional equivalent flap drive assemblies. Continue along the row to column 5 and match the alternate Lockheed part numbers listed there with the Lockheed part numbers shown in column 1. All assemblies listed in the same rows as the matching column 1 entries will also be interchangeable and acceptable as substitute parts.

The author and the *Service News staff* wish to thank Frank D. Middleton of Lockheed Engineering for his assistance in the preparation of this article.

LOCKHEED Part No.	SARGENT Part No.	WESTERN GEAR Part No.	CALCO (CEF) Part No.	LOCKHEED Alt. Part No.	Actuator Position
695676-1	457EA-0(1,2)	1641 E90(1)		695676-5,-9,-13	Outboard
695676-3	457EA-1'~	1642E85(1)		695676-7,-1 1,-1 5	Inboard
695676-5(3)	457EA-5(1)			695676-1 ,,-9,-1 3	Outboard
695676-7(3)	457EA-6(1)			695676-3,-1 1,-1 5	Inboard
695676-9(3,4)	4344EA-1,-3		8446	695676-1 ,,-5,-1 3	Outboard
695676-1 1(3,4)	4344EA-2,-4		8445	695676-3,-7,-1 5	Inboard
695676-1 3(3,4)			8446M 1	695676-1 ,,-5,-9	Outboard
695676-1 5(3,4)			8445M 1	695676-3,-7,-1 5	Inboard

1 No further procurement planned by Lockheed.

2 Service Bulletin A82-188 updates 457EA-0 and 457EA-1 to the failsafe configuration of 457EA-5 and 457EA-6.

3 The -5,-7, and up actuators (and equivalent components under vendor PNs) are equipped with a failsafe nut per LER 2-6330,

4 The -9,-1 1,-1 3, and -15 actuators (and equivalent components under vendor PNs) are extended life units and the preferred spares.



Customer Training Systems Department  
Lockheed - LASC  
Marietta, GA 30063

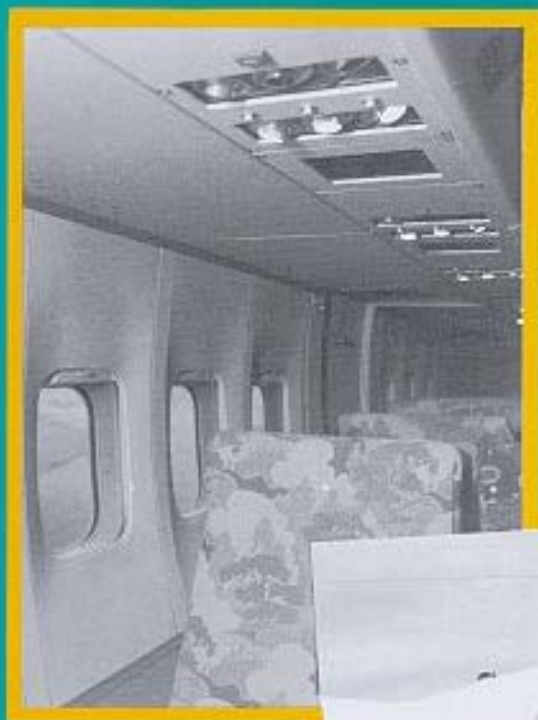

*All of the comforts: This specially modified Merpati L-100-30 provides modern airliner accommodations for up to 97 passengers.*

