

SERVICE NEWS

VOL. 9, NO. 3, JULY-SEPTEMBER 1982

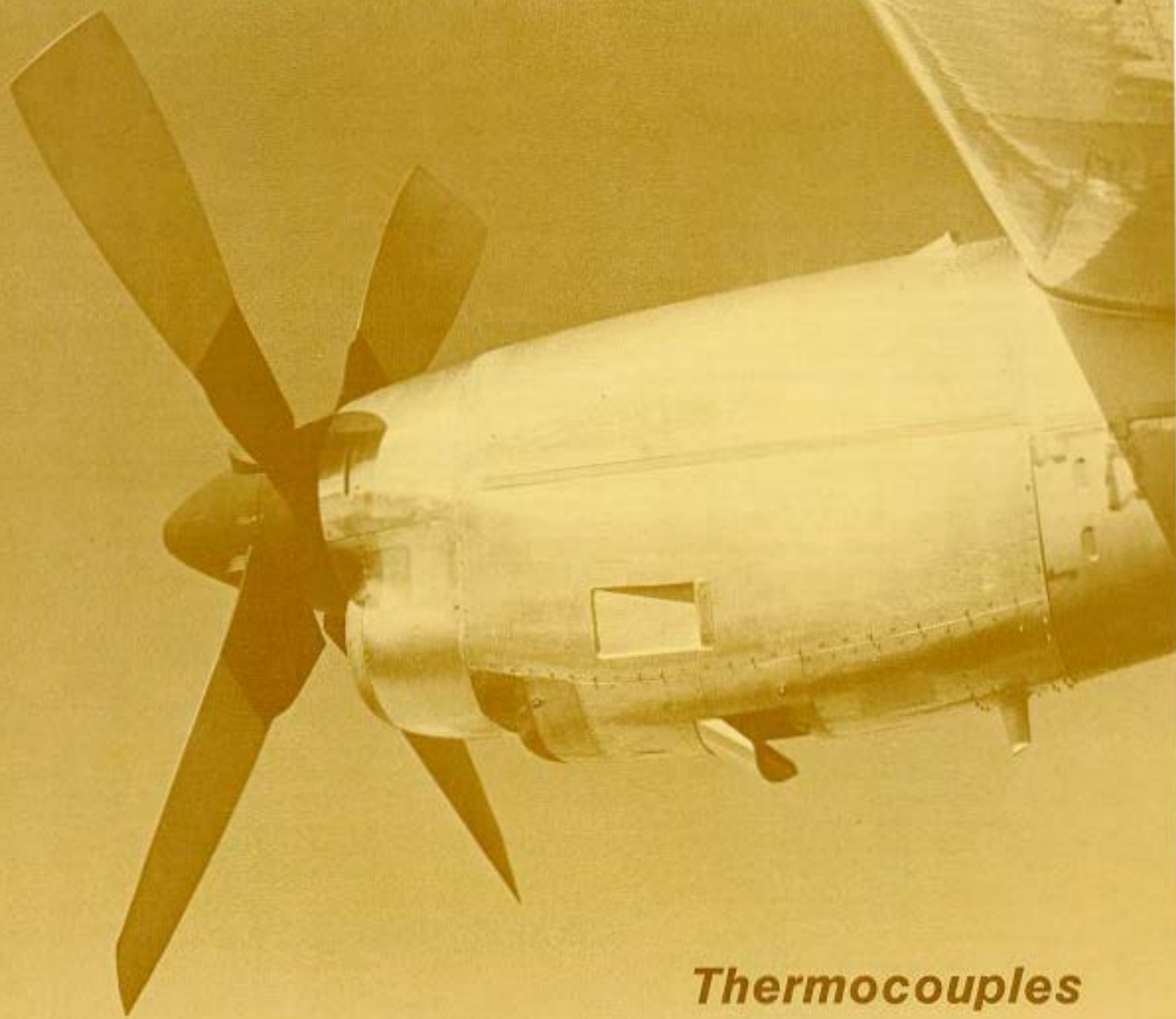

Thermocouples



A SERVICE PUBLICATION OF
 LOCKHEED-GEORGIA COMPANY
 A DIVISION OF
 LOCKHEED CORPORATION

Editor
Charles I. Gale

Associate Editors
Daniel E. Jolley
James A. Loftin
Steve Palmer

Arr Direction & Production
Bill Campbell

VOL. 9, No. 3, July — September 1982

CONTENTS

2 Focal Point

D. L. Fish
 Subcontracts Administrator
 Major Subcontract Procurement

3 Thermocouples and TIT

Understanding thermocouples and their relationship to engine overtemperature conditions.

7 C-130 Derivatives (1982)

An updated chart showing produced and proposed Hercules aircraft.

13 Tips for MLC Inspection, Maintenance, and Emergency Action

6 StarTip

Hints for Maintaining Thermocouples

Cover: The cover picture — and its mirror image on the back page — focus on a vital part of the Hercules aircraft success story, the Detroit Diesel Allison 501/T56-series power plant. Our lead article in this issue reviews some important information about the operation of the thermocouple system in these engines that can help maximize their service life.

Published by Lockheed-Georgia Company, a Division of Lockheed Corporation Information contained in this issue is considered by Lockheed-Georgia Company to be accurate and authoritative it should not be assumed, however, that this material has received approval from any governmental agency or military service unless it is specifically noted This publication is for planning and information purposes only, and it is not to be construed as authority for making change on aircraft or equipment or as superseding any established operational or maintenance procedures or policies. The following marks are registered and owned by Lockheed Corporation: [Logos for Lockheed, Hercules, and JetStar] Written permission must be obtained from Lockheed Georgia Company before republishing any material in this periodical. Address all communications to Editor, Service News, Department 64.22, Zone 278. Lockheed-Georgia Company, Marietta, Georgia 30063. Copyright 1982 Lockheed Corporation.

D. L. FISH

FocalPoint



Keeping Pace

History shows that the advancement of aviation has been greatly influenced, if not paced, by technological accomplishments in propulsion. This fact says a great deal about the importance of propulsion systems. Although the Hercules aircraft was originally introduced in the 1950s, its systems, and specifically its propulsion systems, are keeping pace with the latest technology through product improvements. Lockheed, along with Detroit Diesel Allison and Hamilton Standard, are jointly dedicated to incorporating all proven technological advances which will enhance ease of maintenance, extend service life, and promote product reliability.

This issue of Service News features the engine thermocouple and turbine inlet temperature (TIT) system. Many Hercules aircraft operators have heard the Lockheed/Allison/Hamilton Standard Safety Briefing Team's presentation in which Allison stresses a very practical rule: to extend the life of a turbine, keep it cool. Keeping it cool requires control of TIT, and maintaining the health and well-being of thermocouples is the key to knowing the TIT "truth."

Our feature article also includes a maintenance StarTip which can reduce operator thermocouple usage and overall expense. This helpful advice from Allison is but one example of the continuing dedication of the Lockheed/Allison/Hamilton Standard propulsion team to better understanding and efficient use of their products.

Sincerely,

D. L. Fish
 Subcontracts Administrator
 Major Subcontract Procurement

PRODUCT SUPPORT			LOCKHEED-GEORGIA COMPANY MARIETTA, GEORGIA 30063
T. J. Cleland		Director	
CUSTOMER SERVICE	INTEGRATED LOGISTICS SUPPORT	CUSTOMER SUPPLY	
A. H. McCrum DIRECTOR	J. L. THURMOND DIRECTOR	M. M. HODNETT DIRECTOR	

THERMOCOUPLES AND



The proper operation of the turbine inlet temperature (TIT) indicating system has a critical bearing on the overall operation and the service life of the Detroit Diesel Allison 501/T56-series turboprop engine. Malfunctioning or damaged thermocouples can lead to increased operating temperatures within the turbine and materially reduce engine life. The more that Hercules aircraft operators and maintenance specialists know about the operation of this system, the greater the likelihood that each 501/T56-series engine in the worldwide Hercules fleet will be able to deliver every hour of the long and trouble-free service life that is built into it.

The fuel flow in a 501/T56-series engine is governed by an electronically controlled turbine inlet temperature schedule above crossover. Crossover, which occurs at 65 (+/- 2) degrees coordinator position, is the point at which the electronic temperature datum (TD) control system makes the transition from the temperature-limiting mode (0 to 65 degrees coordinator position) to the temperature-controlling mode (66 to 90 degrees coordinator position) for temperature scheduling.

Two things are needed for the TD control system to function properly in the temperature-controlling range. The first is that a temperature reference signal be

established, or scheduled, for each position of the coordinator above crossover. This signal is used by the TD amplifier as a reference base. The second is that the actual TIT be measured and transmitted to the TD control system for comparison with the reference signal.

The reference voltage is established within the engine TD control amplifier, using input from a potentiometer in the coordinator. The magnitude of the reference signal voltage is dependent upon the position of the throttle above crossover. The scheduled reference temperature range for T56-A-9, T56-A-7, and 501-D22 engines is from approximately 760 to 971 degrees C, and increases linearly from the crossover point to 90 degrees coordinator position. For T56-A-15, T56-A-16, and T56-A-423 engines, the temperature range is from approximately 820 to 1077 degrees C; for the 501.D22A it is 810 to 1071 degrees C.

When the reference signal has been established, a comparison signal that reflects the actual TIT must be generated. This is accomplished by a set of 18 thermocouples arranged around the circumference of the turbine inlet case. The TD amplifier then compares the signal sent by the thermocouples with the reference

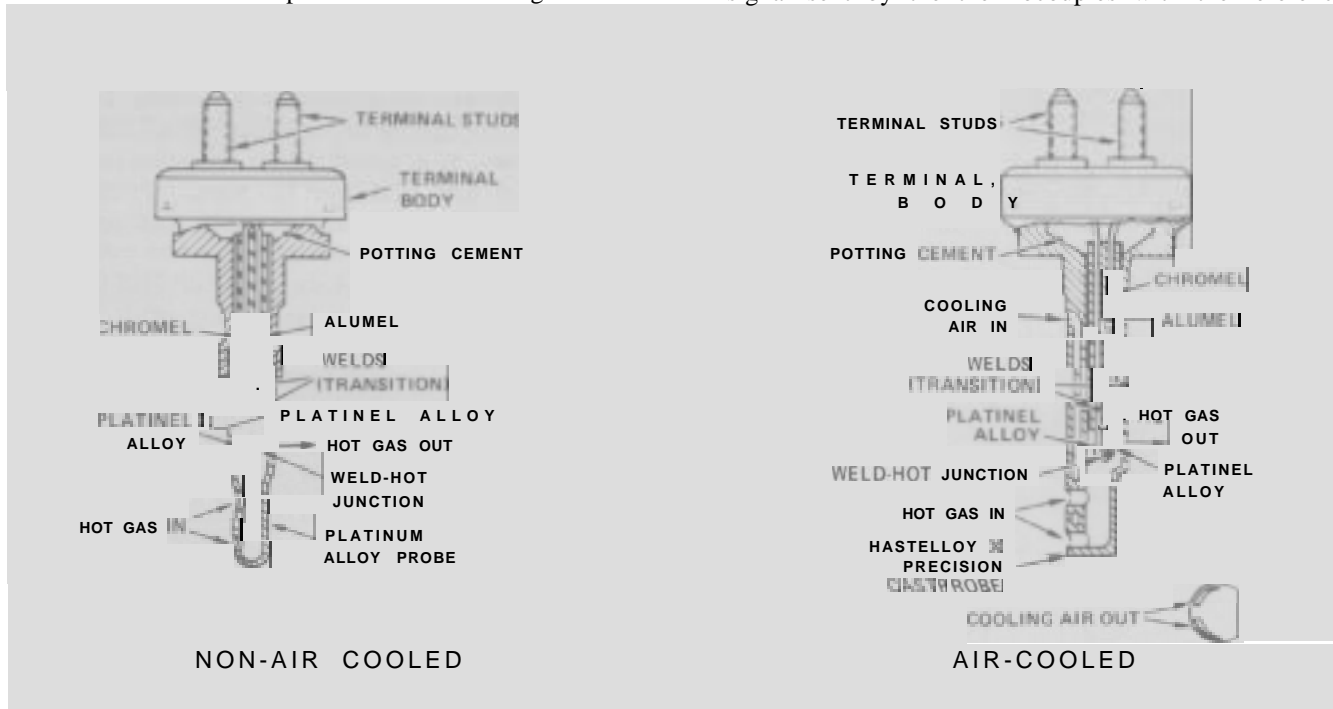

Figure 1. Principal features of non-air-cooled and air-cooled thermocouples.

signal and initiates appropriate changes in fuel flow so that the scheduled TIT selected by the throttle position is attained.

The operation of the thermocouples used in 501/T56 engines is governed by the familiar principles that control similar components used in many scientific and industrial applications. Thermocouples are thermoelectric devices consisting of two dissimilar metals which generate a known voltage between points of contact for a given temperature exposure. The dissimilar metals in the case of these particular thermocouples are wires made of two different heat-resistant platinum alloys. These are joined together at one end to form a junction (Figure 1). The free ends are then welded to alumel and chromel wires which, in turn, are connected to either a flight station TIT indicator or a TD amplifier. This completes the circuit.

When the thermocouples are installed in the engine, the position of the platinum junction is such that it will be exposed to the stream of hot gas that passes through the turbine inlet. The difference in temperature between this sensing element — the thermocouple junction — and the component that serves as a junction at the other “end” of the circuit causes a voltage to be generated that can be used to accurately determine the temperature at the turbine inlet. The average of the voltages supplied by each of the 18 thermocouples is used to establish this value.

The thermocouples used in 501/T56 engines have two separate sensing elements (Figure 2). One sensing element of each of the 18 thermocouples is connected in

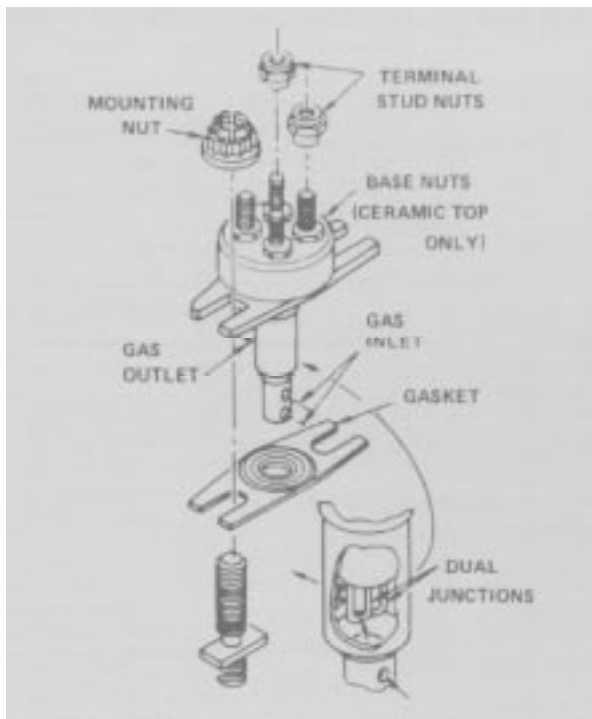

Figure 2. A typical thermocouple: note the two sensing elements (dual junctions).

parallel to provide an averaged signal to the TD amplifier. The TD amplifier uses this signal to determine the actual TIT of the engine. The other sensing element in each thermocouple is also connected in parallel. Its signal becomes part of the averaged signal representing TIT that is displayed on the TIT indicator mounted in the engine instrument panel (Figure 3).

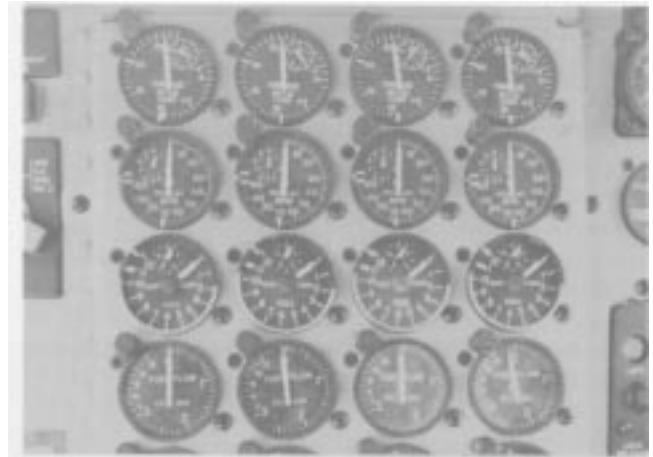

Figure 3. Hercules aircraft engine instrument panel

The 501/T56 family of engines uses a system of multiple thermocouples because the gas flow velocities involved and the short distance between the fuel nozzles and the turbine inlet result in incomplete mixing of the combustion gases. This causes the temperatures measured at the turbine inlet to be nonuniform. The temperature averaging function of the thermocouple circuit in effect samples these stratifications of hotter and cooler areas and supplies an average temperature signal to the TD amplifier and flight station TIT indicator. If any of the thermocouples around the turbine inlet become inoperable or broken, the average TIT signal being sent to the TD amplifier and the TIT indicator will be affected. In the following paragraphs we shall see how an altered TIT signal can cause over-temperature problems and possibly lead to reduced engine life.

Types of Thermocouples

Two basic types of thermocouples are used in 501/T56 engines, one that has no special provision for cooling and one that is air-cooled (Figure 1). A somewhat awkward convention in terminology has become established in which the one type is referred to as “non-air-cooled,” and the other as air-cooled. Note in particular that there are two configurations of the non-air-cooled type of thermocouple. One is used with T56-A-9, T56-A-7, and 501-D22 engines, and the other was installed in earlier T56-A-15, T56-A-16, T56-A-423, and 501-D22A engines. The two configurations are physically similar but functionally distinct. They should never be intermixed in any installation.

The situation is somewhat different in regard to the air-cooled thermocouples now used in new production engines and their non-air-cooled counterparts originally intended for the same application. Air-cooled thermocouples were developed after experience with the higher temperatures encountered in the operation of the T56-A-15, T56-A-16, T56-A-423, and 501-D22A turboprops suggested that increased service life could be expected from thermocouples designed to take advantage of the flow of cooling air available along the inside surface of the turbine inlet case in these engines. The air-cooled thermocouples have proven highly successful and are now designated as preferred spares for the non-air-cooled type made for these power plants. Since in this case the two types are compatible from both a physical and electrical standpoint, a mix is entirely acceptable. Eventually all non-air-cooled thermocouples intended for use in the more recent line of engines will have been removed from service by attrition.

Thermocouple Damage

The most common types of thermocouple damage that set the stage for overtemperature conditions in 501/T56 engines are open sensor circuits in either air-cooled or non-air-cooled thermocouples, eroded probe tip aft walls in air-cooled thermocouples, and missing probe tips in non-air-cooled thermocouples. Such damage can occur if, for example, hot spots develop in the turbine inlet because of improperly functioning fuel nozzles. Hot spots in this location can cause a dramatic increase in erosion and sulfidation of metal surfaces, which greatly reduce the service life of thermocouples. Note also that even under the best of conditions, the effects of heat, erosion, and sulfidation will eventually exact their toll on all thermocouples. This is why thermocouples should be inspected at regular intervals as specified in the authorized maintenance manuals.

Open Circuits

The failure of a thermocouple is an event that has the potential for initiating a whole series of further events, none of them good. Let us first look at what can happen when one or more thermocouples have open circuits. When a thermocouple develops an open circuit, it generally occurs adjacent to the weld point of the two platinum alloys in the sensing element (Figure 4). For the purposes of the following discussion, we shall assume that this has occurred and that both circuits in a thermocouple have failed simultaneously.

Let us also assume that the malfunctioning thermocouple was damaged because of a hot spot in the engine. This implies that the thermocouple that has become inoperable is the one that is located in the hottest part of the engine. The loss of a thermocouple in the hottest part of an engine causes the average temperature signal

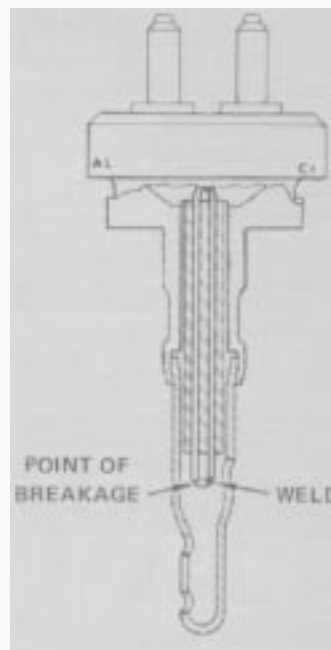

Figure 4. Thermocouple (non-air-cooled) with an open sensing element.

sent to the TD amplifier and the TIT indicator to decrease. A reduced temperature signal to the TD amplifier no longer satisfies the reference signal, so more fuel is allowed to go to the fuel nozzles. This increased flow raises the turbine inlet temperature. The fuel flow will continue to increase until the reference signal is matched by the signal from the remaining thermocouples. Once this has occurred, the TD system will regard the situation as normal and the flight station TIT indicator will display a normal temperature reading. But the situation is not normal. The apparent restoration of normal operation after the loss of the thermocouple has been accomplished at the cost of increasing the actual TIT.

If thermocouples continue to fail more or less sequentially in order of exposure to highest temperature, it is obvious that the engine can operate at ever-increasing actual TIT while normal indications continue to be displayed on the TIT indicator. The true TIT can increase as much as 3.5 degrees C as each succeeding thermocouple fails. Thus with five open thermocouples, a normal reading of 1077 degrees C might be indicated during takeoff roll in an aircraft equipped with T56-A-15 engines, but the true TIT could be in the neighborhood of 1095 degrees C. Such exposure to excessive operating temperatures is very hard on engine components and will result in shortened service life.

Probe Tip Aft Wall Erosion

A different thermocouple problem affects mainly air-cooled thermocouples. This is erosion of the probe tip aft wall, and it has more serious possible consequences than an open-circuit condition. In this case, a hole is

eroded in the downstream side of the thermocouple probe tip (Figure 5). but the two sensing elements remain intact. This kind of damage destroys the ability of the thermocouple to measure the temperature of the gas stream accurately. The result is an erroneous signal that will be averaged into the temperature readings being passed along to the TD amplifier and the flight station TIT indicator.

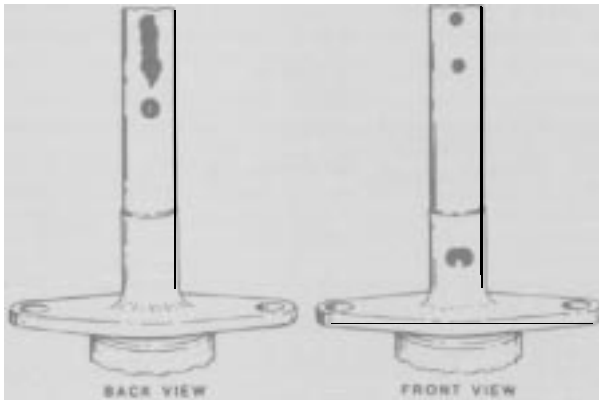

Figure 5. Front and rear view of an air-cooled thermocouple with probe tip aft wall erosion.

Each thermocouple damaged in this way will cause the signal to be approximately 7.5 degrees too low. Since

the TIT signal will now be below the reference signal, the TD amplifier will initiate an increase in the fuel flow to raise the average TIT signal to satisfy the reference signal. When the system stabilizes, the real TIT will be 7.5 degrees C above the indicated value. Again we have an overtemperature condition, but in this case one of greater magnitude. Multiple failures of this type will compound the problem.

The reason that aft probe tip wall erosion can have this effect is related to specific features of the thermocouple design. Fundamentally, the thermocouples used in 501/T56 engines are temperature-sensing, gas-sampling devices. Their bimetallic junctions are not exposed directly to the hot gas, but are instead enclosed in a probe. This probe is designed to obtain samples from two different immersion levels in the gas stream, mix the samples, and then direct the composite sample over the sensor junctions within the probe. After the temperature of the composite sample has been measured, the gas is exhausted from the downstream side of the probe (Figure 6).

When the probe tip aft wall is eroded away, the gas-sampling function of the probe is upset. The combustion gases are not properly mixed and are not directed over the sensor elements before they escape through the downstream side of the thermocouple. This yields a temperature signal that is lower than normal.

(continued on page 11)



HINTS FOR MAINTAINING THERMOCOUPLES

Earlier this year, a Detroit Diesel Allison field representative checked all the engine thermocouples on a brand-new airplane equipped with Series III T56 engines. (Allison's Series III designation includes the T56-A-15, T56-A-15LFE, T56-A-16, T56-A-423 and 501.D22A engines used on various models of Hercules aircraft. The thermocouple problem described here has only been noted on Series III engines.) Eighteen out of the total of 72 thermocouples failed the ohmmeter check because of low resistance between adjacent thermocouple terminals, yet none had been in service more than 20 hours. The field representative, very concerned about this apparently high rate of premature failures, returned the rejected thermocouples to the factory for engineering investigation.

Analysis at Allison's facilities in Indianapolis determined that carbon had deposited between the thermocouple wires where they emerge from the insulator (see accompanying illustration). These deposits caused the low ohmmeter readings observed. It was found that carbon deposits can form in this area when the engine is operated in the taxi range at a TIT below about 700 degrees C for periods of 5 to 10 minutes or more. The carbon discovered in the thermocouples the field representative returned to the factory had evidently been deposited when the aircraft taxied slowly from the runway to the maintenance area after flight. This phenomenon had not been observed during engine tests at Allison previously because virtually all engine testing is done above 700 degrees C TIT. The carbon deposits quickly burn away when an engine is operated at temperatures above 700 degrees C TIT.

These findings have important implications for power plant maintenance

personnel. Carbon deposits can cause low ohmmeter readings and may result in the rejection of a costly and otherwise sound thermocouple. Here are some suggestions that will help avoid unnecessary thermocouple "failures" of this kind.

- 1 Prior to checking thermocouples, run the engine above 850 degrees C TIT for 5 minutes. Shut the engine down normally, but attempt to minimize the operating time at 700 degrees C TIT or below. This procedure should burn off the offending carbon that might interfere with a proper thermocouple resistance check.
- 2 Thermocouples that have been rejected for low resistance can sometimes be salvaged. Try heating the thermocouples in a Jet-Cal tester for a minimum of 3 minutes at 1400 degrees F. If a Jet-Cal unit is not available, heat the junction ends to a cherry-red glow with a propane torch and maintain this heat for 3 minutes. Be sure to protect the terminal ends of each thermocouple — and yourself — from the heat of the torch. Thermocouples that test good after this treatment may be reused or returned to stock.

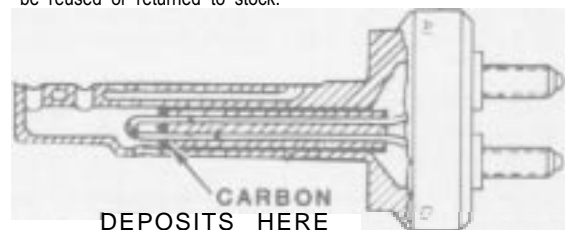

An aerial, black and white photograph of a C-130 Hercules aircraft in a large industrial facility, likely a factory or assembly plant. The aircraft is positioned vertically, with its tail pointing towards the top of the frame. The background shows a complex network of structural beams, walkways, and other aircraft components under construction. The lighting is bright, creating high contrast between the dark and light areas of the aircraft and the factory floor.

***C-130
DERIVATIVES
(1982)***

C-130 Der

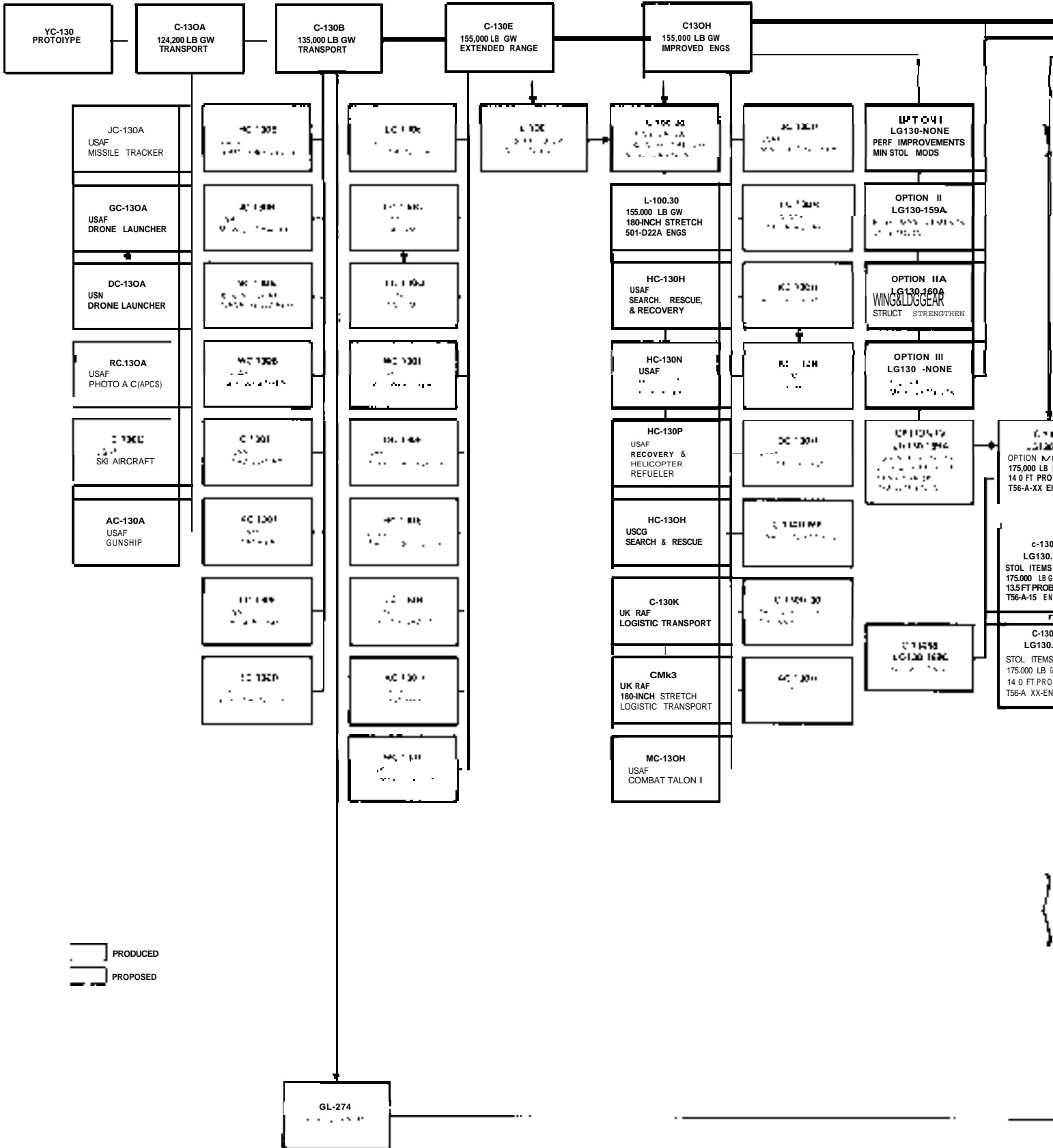

derivatives

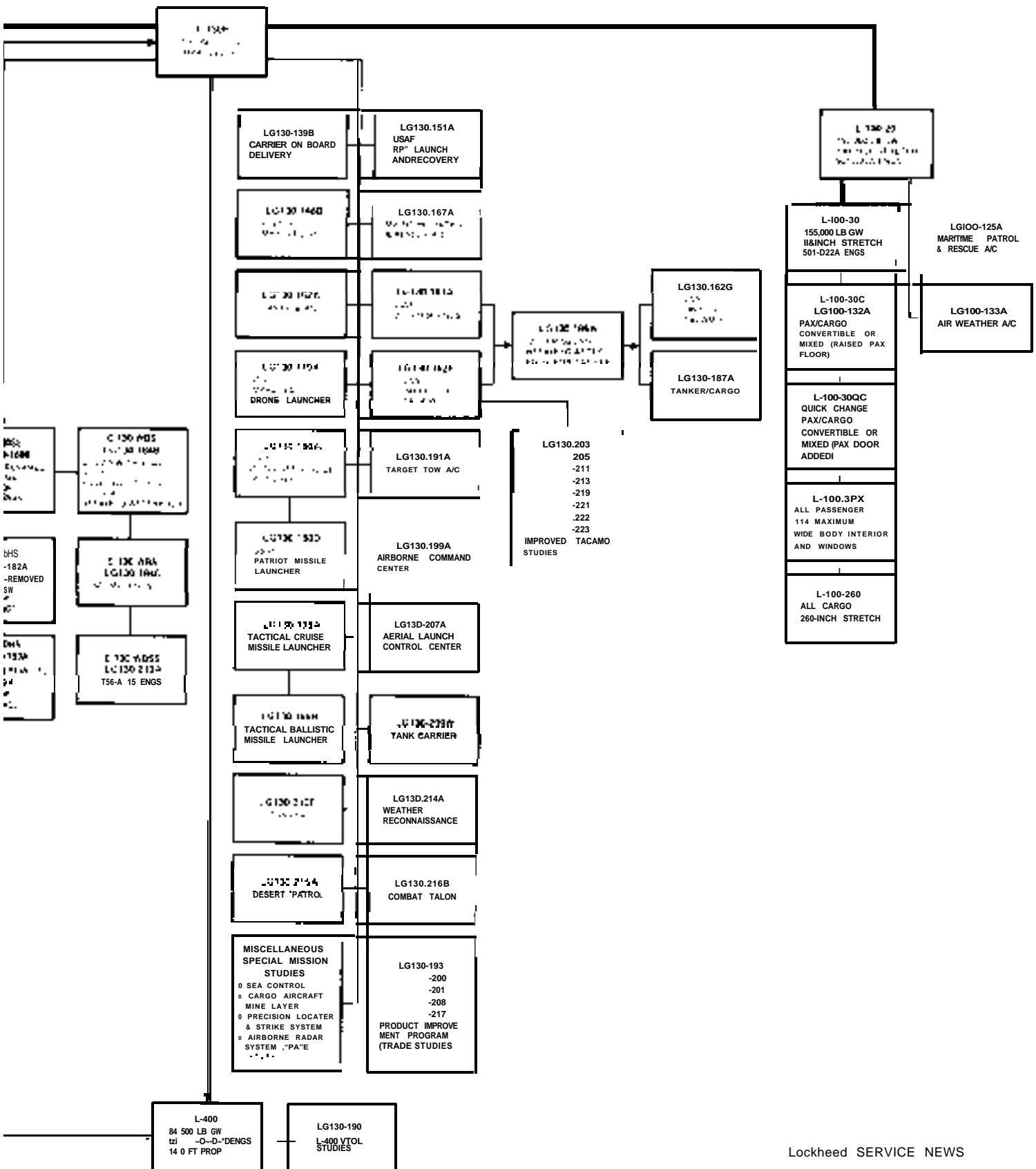



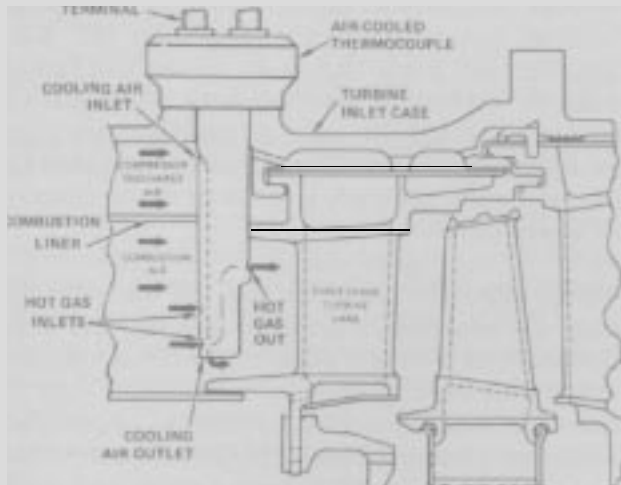

Figure 6. Air-cooled thermocouple installed, showing combustion gas and cooling air flows.

Missing Probe Tip

The last thermocouple problem we shall discuss in this presentation concerns non-air-cooled thermocouples with missing probe tips. This is potentially the most serious condition of all from the standpoint of the possible effects on the TD control system. In this case, the probe tip is completely missing from the affected thermocouple, but again, the two sensing elements remain intact (Figure 7).

In addition to whatever foreign object damage the separated probe tip may inflict on its way through the turbine, the presence in the system of a thermocouple without a probe tip has a marked effect on the average temperature signal being received by the TD amplifier and the TIT indicator. Each missing probe tip will cause the average temperature reading to be about 22 degrees C too low. Here again, since the TIT signal will then be below the reference signal, the TD amplifier will call for additional fuel to raise the average TIT signal to match the value of the reference signal. The result is a severe overtemperature condition, one much worse than any of those previously described.

When a thermocouple probe tip is missing, the ability of the probe to perform its vital gas-sampling function is completely lost. The gas sample cannot be obtained from deep within the gas flow where the temperatures are highest. Instead, the sensing elements are exposed to the relatively cool environment at the periphery of the combustion gas path. This means that the affected thermocouple will introduce an excessively low gas temperature signal into the system, with serious consequences for the operation of the engine.

To gain an appreciation of just how serious the impact of lost thermocouple probe tips can be, let us assume that we are operating a T56-A-7 engine that is performing properly except that three of its thermocouples have missing probe tips. Remember that each thermo-

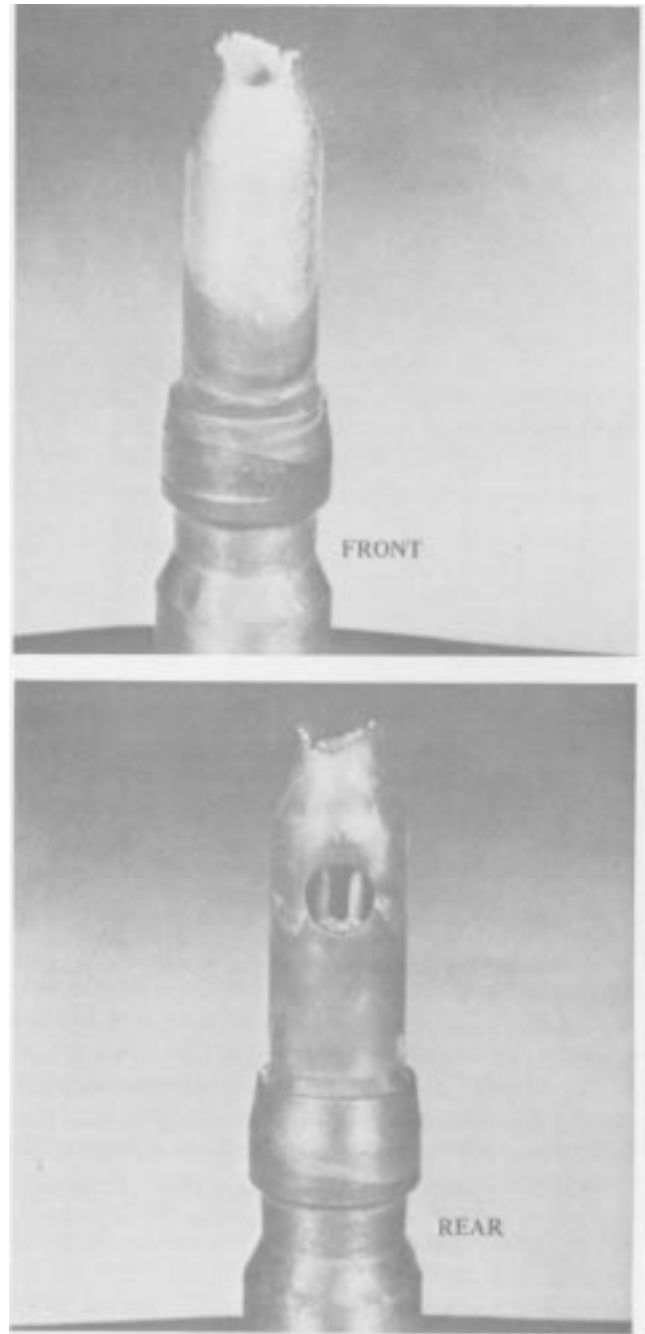

Figure 7. Front and rear view of a non-air-cooled thermocouple with probe tip missing.

couple with a missing tip introduces an error that results in the average TIT signal being 22 degrees C below the true temperature. Since the error is cumulative and there are three thermocouples with missing tips, the indicated TIT for this engine is going to be approximately 66 degrees C below the real value. Figure 8 shows the correlation between the indicated and actual TIT of an engine that has one or more thermocouple probe tips missing. This means that at an indicated takeoff TIT of 971 degrees C, the actual TIT would be 1037 degrees C. Even at the maximum continuous permissible TIT of 932 degrees C indicated, the true TIT would exceed that of takeoff TIT, which is

operationally limited to five min

temperatures described in this example for any extended period of time.

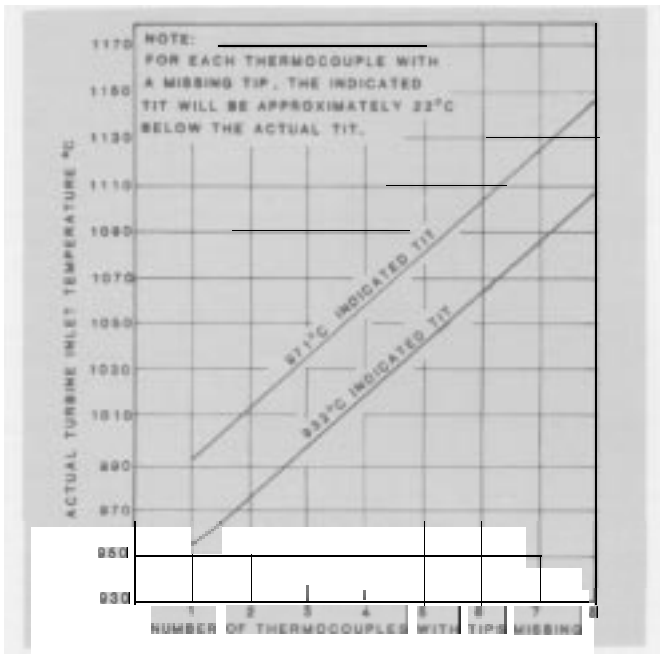

Figure 8. Indicated and actual TIT in a 501 -D22/T56-A-7 engine with one or more thermocouple probe tips missing.

Preventing overtemperature Damage

From the foregoing, it is clear that the proper operation of all 18 thermocouples is crucial for long life and efficient performance of any of the fine power plants in the 501/T56 family. A little extra time and effort spent making sure that these thermocouples are functioning as they were designed to do is a worthwhile investment.

Beyond strict adherence to the thermocouple maintenance and inspection procedures set forth in the authorized manuals, the best insurance against overtemperature damage brought on by malfunctioning thermocouples is vigilance. It is hard to improve upon the protection offered when flight crews and maintenance crews remain on the alert for the signs and symptoms of something amiss in the TD control system that just might turn out to be thermocouple trouble.

This is an area where being suspicious can pay off. The main clue that an engine may have a hidden overtemperature condition is generally an abnormal relationship among its operating parameters as shown on the engine instrument panel. Fuel flow is often the key parameter to watch. Higher than normal fuel flow above crossover for a given TIT is one possible sign of malfunctioning thermocouples. We have already seen the reason for this: increased fuel flow to raise the average TIT signal from the thermocouples to match the value of the reference signal.

Another indication of malfunctioning thermocouples is higher than normal torque for a given TIT. Since fuel flow and torque are closely interrelated, an increase in fuel flow to raise the average TIT signal will also cause the engine's torque output to increase. Careful attention to the fuel flow and torque indicators can pay substantial dividends in terms of timely detection of overtemperature conditions.

We have already noted that the TIT indicator will often not be a reliable guide to the actual TIT when thermocouple trouble is present. Usually the indicated TIT will be lower, sometimes much lower, than the true value. You can make use of this fact to perform a simple test when problems in the thermocouple system are suspected. With all engines running and above crossover, position the throttle levers so that torque and fuel flow for each are approximately equal. An engine with thermocouple damage will show a noticeably lower TIT than the other three.

Finally, an important thing to keep in mind is that turbine engines never get better with age. They can only deteriorate as the combined effects of heat, erosion, sulfidation, corrosion, and wear gradually reduce their efficiency. A 501/T56-series turboprop engine that appears to be improving with use — producing more torque at the same indicated TIT, for example — should immediately attract your attention. Some things are too good to be true and this is one of them. It is very probable that there are problems in the TIT indicating system of this engine and prompt action is needed to prevent overtemperature damage.

In the 501/T56 engines that power Hercules aircraft, the thermocouples of the TIT indicating system have a vital function to perform. They have an important job to do and a tough place in which to do it. Rugged and reliable, they operate hour after hour under conditions where most materials, let alone precision measuring instruments, would be destroyed instantly. When they do fail, the temperature control they provide fails with them. Without the protection of a properly operating thermocouple system, an engine can literally be consumed by its own internal fires.

Preventing the onset of conditions where anything like this is possible should be high on the priority list of every flight crew member and power plant maintenance specialist. Timely detection and prompt intervention are key parts of any effective program to protect 501/T56 turboprop engines against premature failure caused by overtemperature operation. The other parts of such a program are the indispensable ingredients of every other successful aircraft maintenance effort: a solid background in the fundamentals, a thorough knowledge of the system and its maintenance requirements, and a dedication to completing every task in a safe and fully professional way.

Tips for MAIN LANDING GEAR Inspection, Maintenance, and Emergency Action

Whenever an inspection of a Hercules aircraft main landing gear is carried out, it is important to determine that the mechanism is free to extend and retract without the landing gear shoes binding or sticking in their tracks. The procedures and comments that follow should be helpful whenever gear inspections are made, or whenever it is suspected that a binding condition is developing in a main landing gear.

Although binding may occur during either extension or retraction of the main landing gear, binding that is sufficient to cause the gear to actually stop usually occurs when the gear is being retracted. This tendency of the gear to stick during retraction, rather than extension, can be blamed on gravity. The mechanism must work against the weight of the gear to retract it, while the weight of the landing gear helps in its extension. A tendency for the main landing gear to bind can sometimes be detected in advance when abnormally slow gear retraction (longer than 19 or 20 seconds) is noticed.

A number of factors can cause binding of the main landing gear. Problems with the shoe-to-track interface, the condition of the ballscrews, improper friction washer clearance, a sheared or lost friction washer adjusting nut locking screw, or foreign objects on the shelf bracket can all cause the main gear to bind or lock during extension or retraction.

Shoe-to-Track Interface

The condition of the shoe and track surfaces may impair proper gear operation by preventing free shoe movement. Stepped areas or score marks should be blended out so that no rough surfaces are present on the shoes or tracks. Rough areas should be eliminated because they may hold dirt and grit which can impair smooth shoe movement.

Failure to keep the main landing gear tracks free of dirt or grime may prevent the gear from operating properly. One Hercules aircraft operator, who was using his aircraft in a remote area under unfavorable climatic conditions, experienced a series of incidents on several aircraft in which the operation of the gear would bog down after about 8 inches of retraction. The operator incorporated track cleaning procedures once every five landings and this remedied the binding. Since the accumulation of dirt varies with operating conditions, the track-cleaning frequency should also vary. Operation in sandy or dusty environments will naturally require more frequent cleaning of the tracks.

Last, but by no means least, the clearance between the tracks and shoes should be checked frequently. A minimum of 0.010 inch fore and aft clearance should be maintained at the minimum clearance location. (The original minimum of 0.005 inch was revised several years ago.) The procedure for checking the track clearances on C-130A aircraft involves the use of a feeler gauge, but the preferred method of checking and adjusting tolerances on B, E, and H models is to

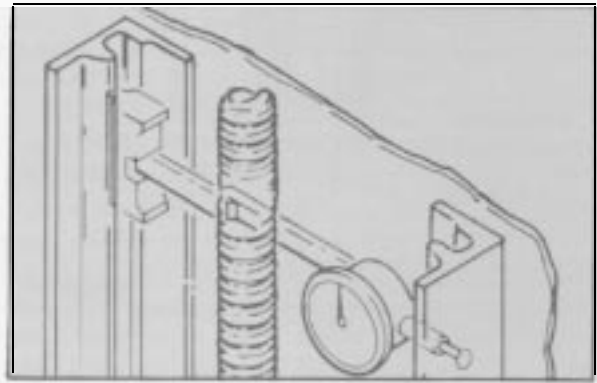

Figure 1. Track width indicating tool.

use a track width indicator, P/N 3402044-1 (Figure 1). Detailed instructions for checking shoe-to-track clearances are contained in the authorized landing gear maintenance manuals. Further information can also be found in an article entitled "MLG Track Shoe Clearances," which appeared in Volume 6, Number 1 (January – March 1979) of *Service News*.

Ballscrew Condition

In order to ensure proper extension and retraction of the C-130 main landing gear, the ballscrews should be inspected frequently for cleanliness, condition, and adequate lubrication. Most reported cases of binding gear have been corrected by cleaning and lubricating the ballscrews in conjunction with cleaning the tracks. If an inspection discloses rough areas on the ball thread, there may be problems inside the ball nut. Foreign matter such as dirt or grit may be present inside the nut, and the recirculating balls inside the nut may be damaged (Figure 2).



Figure 2. Cross-sectional view of ball nut (typical).

Friction Washer Clearance

Insufficient clearance between the main landing gear friction washer and the spacer located next to the trunnion assembly will prevent gear retraction. The minimum clearance between the washer and the spacer is 0.005 inch. If the clearance is 0.005 inch and the locking bolt hole in the ballscrew is not aligned with a locking slot, the adjusting nut should be backed off (counterclockwise) to the nearest slot on the nut that will align with this bolt hole. A new locking screw, washer, and self-locking nut should be installed (Figure 3). The nut on the locking screw should be tightened to a torque value of 12 to 15 inch-pounds.

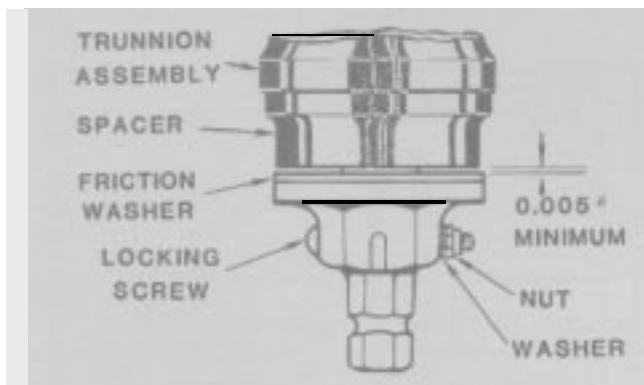

Figure 3. Lower portion of ballscrew assembly, showing friction washer to spacer clearance and locking screw.

Sheared or Lost Friction Washer Adjusting Nut Locking Screw

A sheared or lost locking screw may allow the large friction washer adjusting nut to move on the ballscrew shaft. The locking screw is the screw that locks the large nut to the ballscrew shaft. If the locking screw is lost or sheared, the nut may move on the ballscrew shaft. If the nut tightens on the ballscrew shaft, it may lock the ballscrew in a retracted or partially extended position. If the adjusting nut loosens, it may come off the ballscrew shaft, allowing the affected shock strut to rise in the gear tracks without restraint when the aircraft lands, resulting in possible serious damage to the aircraft.

Foreign Objects on the Shelf Bracket

If a nut, rock, socket tool, or other object is on top of the shelf bracket, the object may shift during flight so that it is between the shelf on the gear and the shelf bracket. When the main landing gear is extended, the shelf on the strut cylinder may bottom on the object. This will prevent the ball nut from bottoming on the ballscrew lower bumper stop, which normally stops

ballscrew rotation. In such a case, the friction washer may engage and lock the gear down. This problem is generally considered a nuisance item, since the gear usually extends sufficiently to engage the drag pins.

Emergency Tips

Most military versions of the Hercules aircraft are equipped with MLG inspection windows located in each wheel well side wall at FS 522 and FS 583. It is a good idea for all flight crew personnel to be familiar with the appearance of the main landing gear in the down position when viewed through these windows (Figure 4). A potential cause of gear malfunction can sometimes be detected visually well before trouble actually develops, permitting timely corrective action.

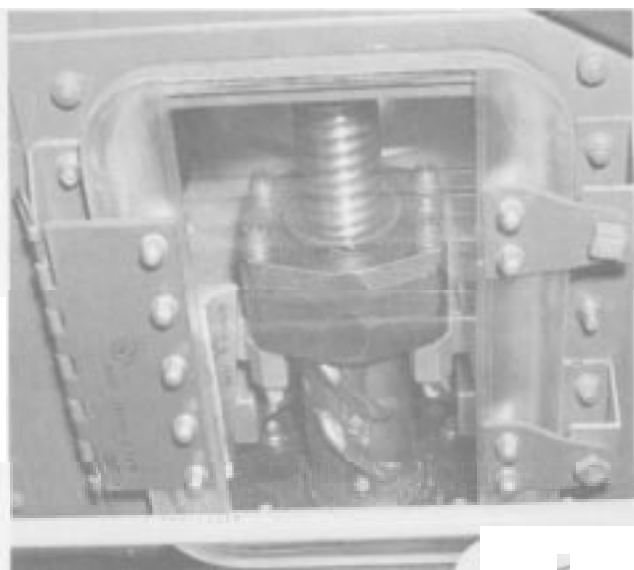

Figure 4. MLG inspection window-gear in down position.

If your aircraft is equipped with landing gear inspection windows, they should be cleaned as often as necessary to ensure a clear view. Remove dust from the surface of the plastic windows with a soft, clean cloth that has been saturated with clear water. Do not use a dry cloth. Wipe the windows carefully with a soft, damp cloth or sponge. Keep the cloth or sponge free from grit by rinsing frequently in clean water. Finish up by cleaning the windows with an approved non-abrasive plastic polish.

In case of a hydraulic failure or other condition that requires manual extension of the main landing gear, the manual extension system must be engaged by pulling a T-handle. T-handles for the left and right main gear are located on the forward wall of the left and right wheel well. The handle cables must be free to shift to manual drive in an emergency.

On E-model and later Hercules aircraft, freedom of movement of the T-handle cables is not normally checked, since the cables should not be activated on the ground unless the aircraft is on jacks. In order to ensure that cables are free from binding, follow this procedure:

1. Carefully disconnect the T-handle cable from the manual gearbox assembly shift lever (Figure 5).
2. Operate the T-handle several times to check that the cable is free to move.
3. Reconnect the T-handle cable to the shift lever.

The amount of extension torque that can be applied to the main landing gear varies from one method of extension to another. The manual gear extension drive will apply higher extension torque than the hydraulic motor can provide. Then, an emergency wrench can be used directly on the ballscrews to provide still higher extension torque to the gear. Note that the use of the emergency wrench to extend the main landing gear should be initiated only after all other normal and emergency procedures have been attempted.

If you must use the emergency wrench to extend the

gear, follow the steps outlined below. After gaining access to the lower end of the vertical torque shafts via the wheel well side panels, it is possible to disconnect both the forward and aft gear ballscrew by removing four nuts and screws attached to a flange on each vertical torque shaft below the universal joints.

Since the motion of the aft gear opens the gear doors, disconnect the aft gear first and extend it approximately halfway down, using the emergency wrench. Extend the forward gear next. Finally, extend the aft gear the rest of the way. You can extend the aft gear only part-way initially because the torque strut will bind under the bottom of the piston if the gear is extended beyond about 50 percent. This binding may load the shoes against the tracks and stop the gear from further extension. If jamming does occur, it will then be necessary to retract the low gear slightly to relieve the strut binding before either the front or rear gear can be extended any further.

Proper maintenance and inspection practices can go a long way toward improving the reliability of the already dependable Hercules aircraft main landing gear. It is hoped that the steps we have just discussed will spare your personnel from the unwanted excitement that a hung gear can produce, and at the same time contribute to timely action just in case there is a gear emergency aboard a Hercules aircraft.

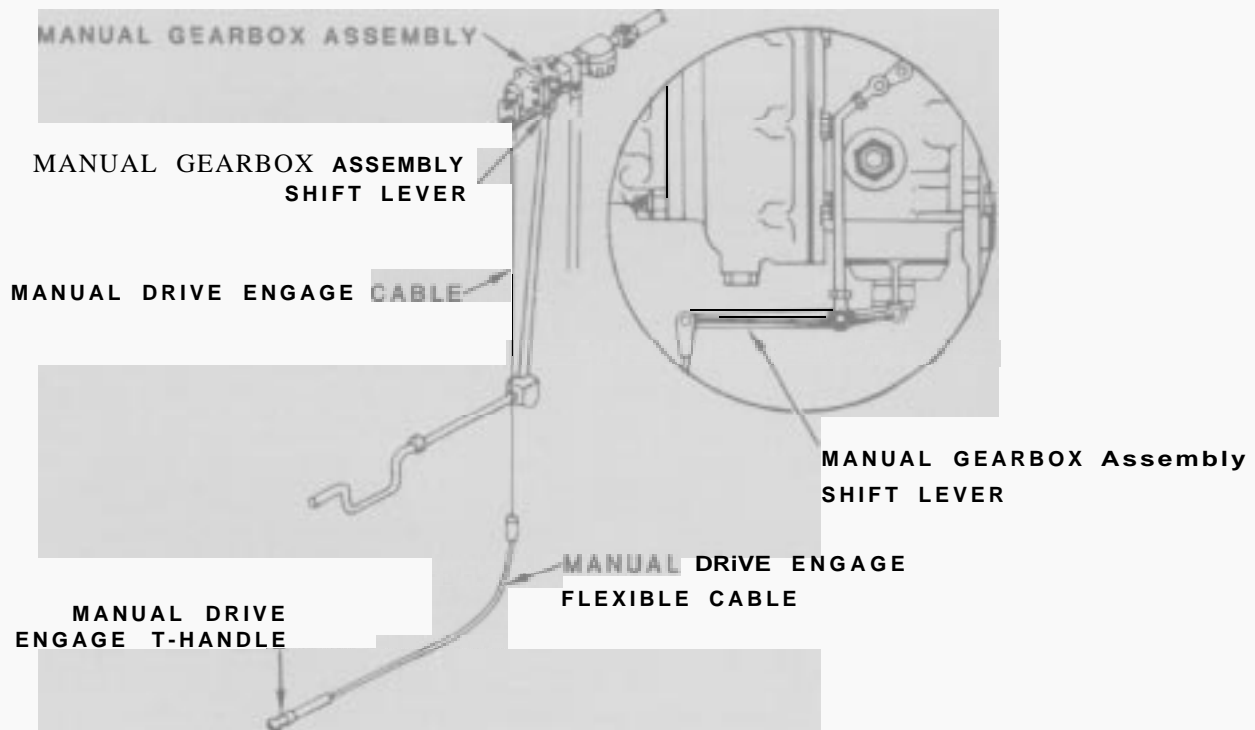

Figure 5. MLG manual extension system components.

CUSTOMER SERVICE
LOCKHEED-GEORGIA COMPANY
A Division of Lockheed Corporation
Marietta, Georgia 30063

