

SERVICE NEWS

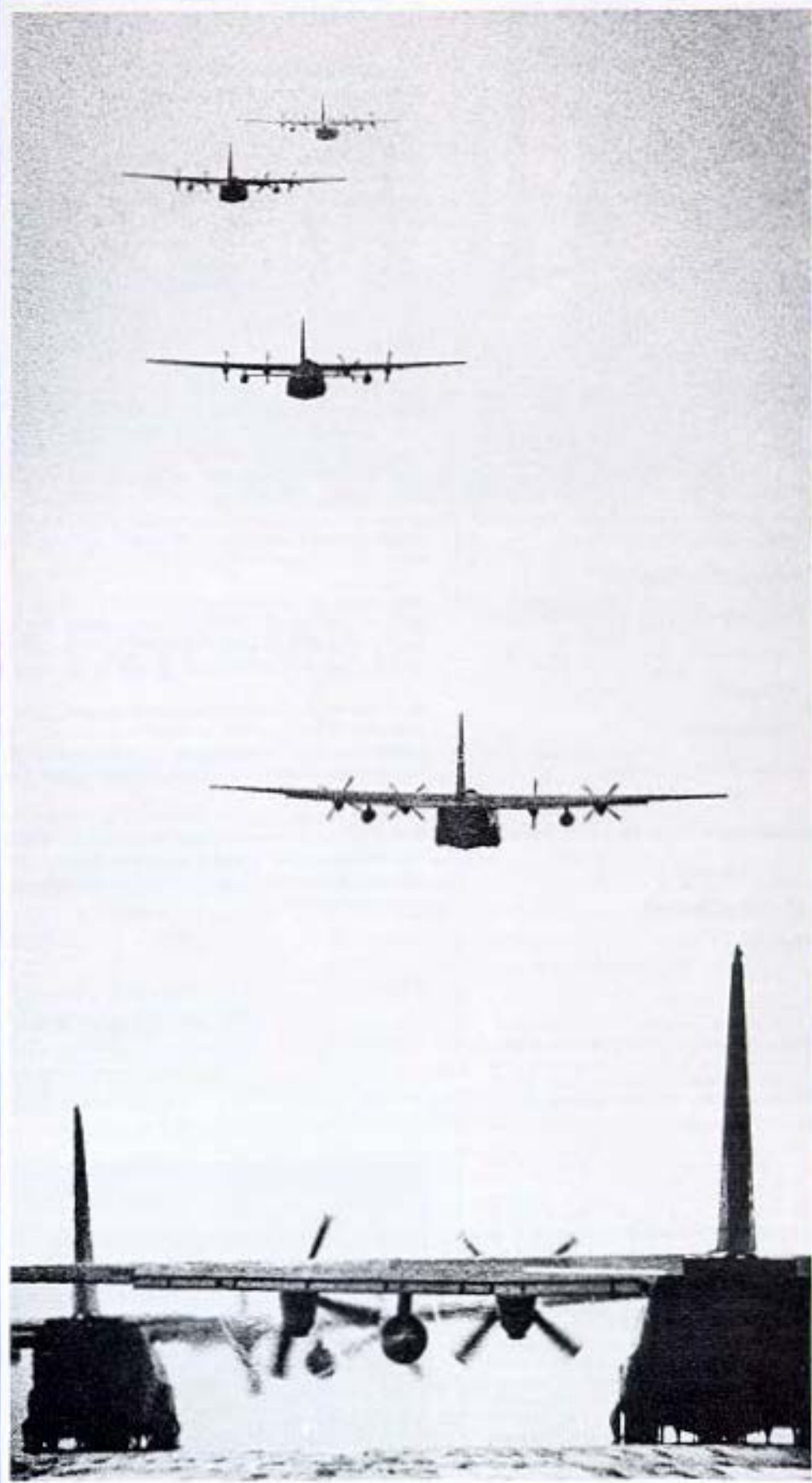

service news

A SERVICE PUBLICATION OF
LOCKHEED-GEORGIA COMPANY
A DIVISION OF
LOCKHEED CORPORATION

Editor

Don H. Hungate

Associate Editors

Charles I. Gale

James A. Loftin

Arch McCleskey

Patricia A. Thomas

Art Direction & Production

Anne G. Anderson

Vol. 6, No. 4, October-December 1979 CONTENTS

2 Focal Point

O. C. Brockington, C-130

Engineering Program Manager

3 Meet the Hercules

5 Dimensions

6 Fact Sheet

7 Airframe

9 Fuel System

12 Power Plant, Propellers, and the APU

15 Pneumatic Systems

19 The Hydraulic Systems

22 Electrical System

24 Tattoo

Cover: The striking photograph on our cover was selected as the USAF's Best Photo of the Year in 1978. TSgt. L. Emmett Lewis Jr. did the superb camera work during a 20-second interval formation takeoff by the C-130s of the 37th Tactical Airlift Squadron, Rhein Main AB, Germany.

Published by Lockheed-Georgia Company, a Division of Lockheed Corporation. Information contained in this issue is considered by Lockheed-Georgia Company to be accurate and authoritative it should not be assumed, however, that this material has received approval from any governmental agency or military service unless it is specifically noted. This publication is for planning and information purposes only, and if is not to be construed as authority for making changes on aircraft or equipment, or as superseding any established operational or maintenance procedures or policies. The following marks are registered and owned by Lockheed Corporation:  "Lockheed", "Hercules", and "JetStar". Written permission must be obtained from Lockheed-Georgia Company before republishing any material in this periodical. Address all communications to Editor, Service News, Department 64.22, Zone 278, Lockheed-Georgia Company, Marietta, Georgia, 30063. Copyright 1979 Lockheed Corporation.

FocalPoint

The C-130 and Special Projects Engineering Division is pleased to welcome you to a special "Meet the Hercules" edition of Service News magazine. This issue is devoted entirely to a description of the systems and features of the current production models of the Hercules aircraft, the Advanced C-130H, and the L-100-30. Our primary purpose is to better acquaint you with these two most recently updated members of Lockheed's distinguished family of Hercules airlifters, but first we'd like to say a few words about the engineering organization that stands behind them.

We in the Project Design organization have the responsibility for the configuration and systems operation of all new or modified C-130 or L-100 aircraft. During the past 26 years, we have been intimately involved with all facets of Hercules design and maintenance. Our goal is to keep the Lockheed Hercules the most efficient and versatile cargo aircraft in the world. We encourage our customers to communicate their field experiences and recommendations to us so that we can pass along information which will be useful to all operators, and act on those items that would benefit from engineering attention.

Other design groups within the Engineering Division apply their ingenuity and skills in the continuing effort to improve the reliability, maintainability, and performance of the aircraft. Within each of these groups we have specialists in every area: structures, power plant, environmental, hydraulics, and electrical, to name just a few.

Our Commercial Customer Engineering Support Group concentrates on coordinating all matters pertaining to L-100 aircraft operation with our many users. Staff members of the Support Group handle all commercial manuals, service bulletins, FAA documentation and customer inquiries. They also offer troubleshooting ideas and maintenance assistance whenever it is needed.

All of this adds up to a full-time team of professionals who stand ready to help you with any engineering or maintenance questions you may have. We hope that this issue of Service News will be beneficial to you, and should you require additional information, we invite you to contact your local Lockheed Representative, or the Project Design office directly. We always welcome your ideas, comments, and suggestions.

Sincerely,

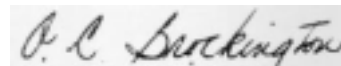

O.C. Brockington
C-130 Engineering Program Manager



PRODUCT SUPPORT		LOCKHEED-GEORGIA COMPANY, MARIETTA, GEORGIA 30063	
DIRECTOR		T. J. CLELAND	
CUSTOMER SERVICE DIVISION		CUSTOMER SUPPLY DIVISION	
DIRECTOR	O. L. BRAUN	DIRECTOR	M. M. HODNETT
FIELD SERVICE & INVENTORY	A. H. TRIGUM	SUPPLY PROCUREMENT	J. W. PERCE
CUSTOMER TRAINING	E. L. PARKER	SUPPLY SYSTEMS & INVENTORY CONTROL	G. S. ALLEN
JETSTAR SUPPORT	M. L. BURNETTE	SUPPLY SALES & CONTRACTS	H. T. NISLEY, JR.
MANUFACTURING & SUPPORT	P. P. LITVIN	SUPPLY & TECHNICAL SUPPORT	J. L. THURMOND



USAF photo, TSgt L. E. Lewis Jr.

Meet the Hercules

The YC-130, prototype of the Hercules aircraft, made its first flight on 23 August 1954. More than a quarter century has passed since then, and many variants of the same basic design have been produced. Each step of the way, modifications and improvements were incorporated which contributed to the evolutionary process by which this unique airlifter has maintained a position of pre-eminence among modern cargo aircraft.

While few in the aerospace field would dispute the value of technical advancements, a policy of continuing improvement also imposes special obligations. For those of us involved in operating and maintaining the Hercules, it means that periodically we need to stop, step back, and take a good overall look at our airplane. We need to review its features, its systems, and the enhanced capabilities that the latest design changes have made possible. Perhaps even more important, we also have an obligation to help aircraft service professionals just recently assigned to the Hercules familiarize themselves with all systems of the aircraft, in particular those systems which might be outside of their areas of specialization.

That is really what this special issue of Service News is all about. It is an overview in which we will present a general description of the current production Hercules: the Advanced C-130H and L-100-30 versions of the airplane. Although our text is directed primarily toward the people who are new to Hercules aircraft maintenance, we think that even the experienced "old hands" will discover

some things in these pages which they will find both useful and informative.

Please note that we are going to be talking specifically about the most recent versions of the Hercules. Much of the information will be applicable to earlier models, but to get detailed data about your Hercules aircraft and its systems and equipment, you will want to refer to the training and technical manuals that were prepared especially for it.

Originally, the C-130 was designed as a tactical military cargo transport. It was built to operate unsupported out of remote locations. The onboard gas turbine compressor (GTC) provided a reliable source of compressed air for starting the engines or, with the help of an air turbine motor (ATM), generating electrical power. Rugged construction and powerful engines gave the Hercules the ability to use short, unpaved airstrips. The rear cargo ramp and spacious cargo compartment set new standards of convenience in loading and unloading, particularly when outside equipment was involved.

The first production model was the C-130A. It was powered by Allison T56-A-1A (and later, T56-A-9) turboprop engines driving three-blade Aeroproducts propellers. The A model had a gross takeoff weight of 124,200 pounds (56,335 kg), of which 35,000 pounds was payload. Its range was about 1900 nautical miles (3519 km).

In 1958, the first B model was produced. It featured a new four-blade propeller built by Hamilton Standard, and an uprated engine, the T56-A-7. Each of the new engines developed 4050 equivalent shaft horsepower (eshp), an increase of nearly 8% over those of the C-130A. The B model also incorporated bladder tanks in the center wing section for increased range. These improvements, plus changes in the hydraulic and electrical systems, brought the maximum gross takeoff weight on the B model to 135,000 pounds (61,235 kg).

The C-130E was introduced in 1961. The E model featured a number of structural improvements which upped the maximum payload to 45,000 lbs, but the major external difference was the addition of a pylon tank under each wing between the engines. Together, these tanks could add over 18,000 pounds of fuel to the total capacity of the aircraft. The gross weight also increased, of course, to 155,000 pounds (70,307 kg).

In 1965, the Hercules airplane made its debut in the world of commercial air service with the L-100, a design essentially derived from the C-130E. All subsequent L-100s have also shared most of their basic structural features with concurrent military models, but they are specifically outfitted for commercial use.

The special requirements of commercial operators led, in fact, to the development of an important new branch of the Hercules family tree, the "stretched" models. The first stretched Hercules rolled out in 1968. It was designated as the L-100-20, and its cargo compartment is 100 inches (2.54 m) longer than that of the baseline L-100. The L-100-20s were also the first aircraft of the L-100 series to

be equipped with the Allison 501-D22A engine, a commercial version of the T56-A-15 turboprop. An even longer stretched model was added to the line in 1970, the L-100-30. This Hercules airfreighter has a cargo compartment that is 80 inches (2.0 m) longer than that of the L-100-20s.

1965 was also the year that the first C-130H appeared. The H model was fitted with a more powerful engine, the Allison T56-A-15, which develops up to 4910 eshp. The new engines increased the capability of the Hercules by improving hot-day and high-altitude performance; they also provide better specific fuel consumption.

The Advanced C-130H, which is being featured in this special issue, was introduced in 1977. In addition to the improved engines of the earlier H models, the Advanced C-130H is equipped with a modern auxiliary power unit (APU) to replace the GTC, and a redesigned air-conditioning system.

Now it is time to move from the general to the specific. In the following pages you will find more complete information about our most modern Hercules airplanes. We will discuss their dimensions, capacities, and the features of many of their systems (avionics has been largely omitted since much of this equipment is custom-installed in response to user requirements). We hope that the articles, charts, tables, and pictures will be truly helpful, and serve as a useful guide to today's updated, efficient, and dependable Hercules airlifters.

SERVICE NEWS



Overall Dimensions

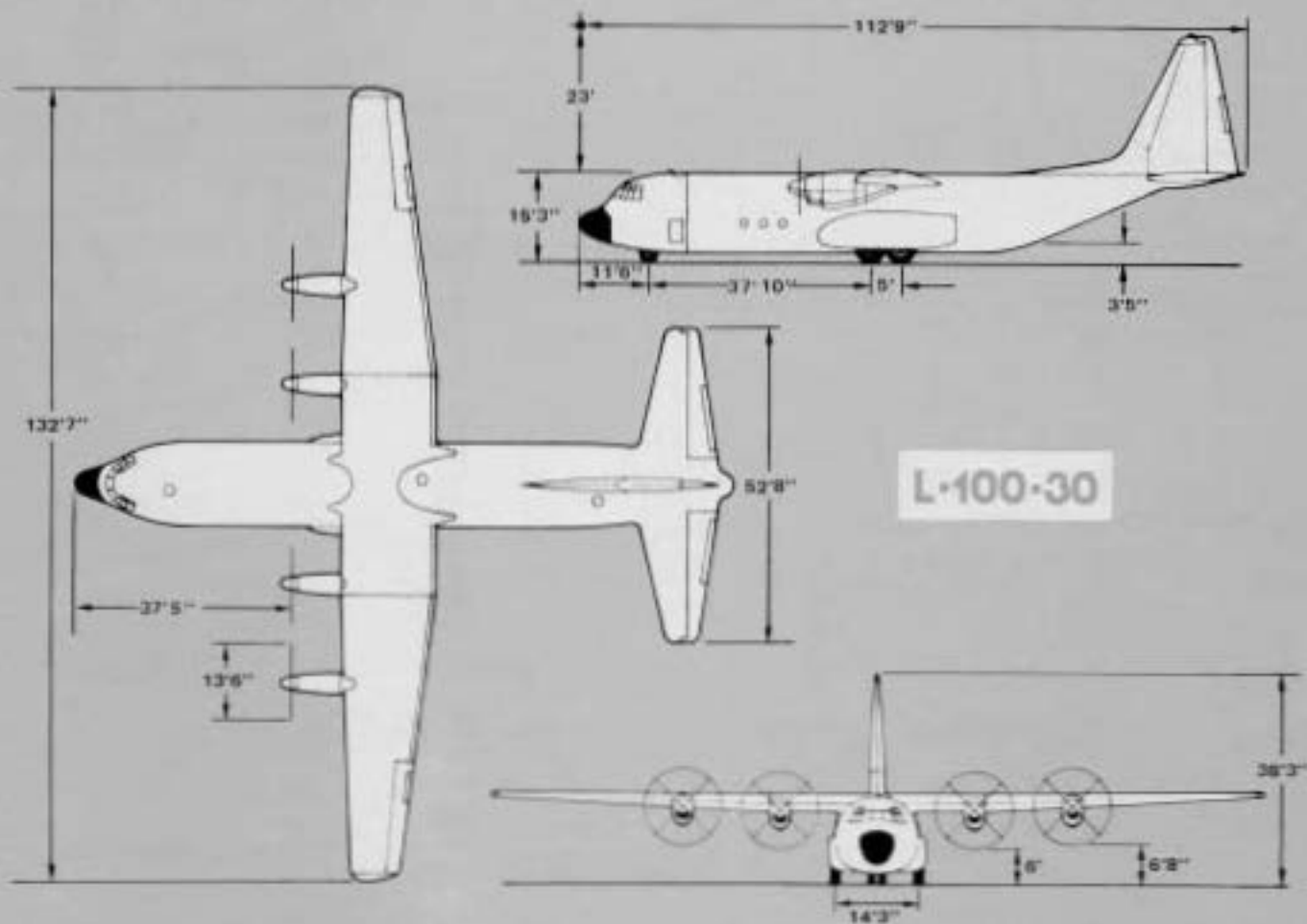
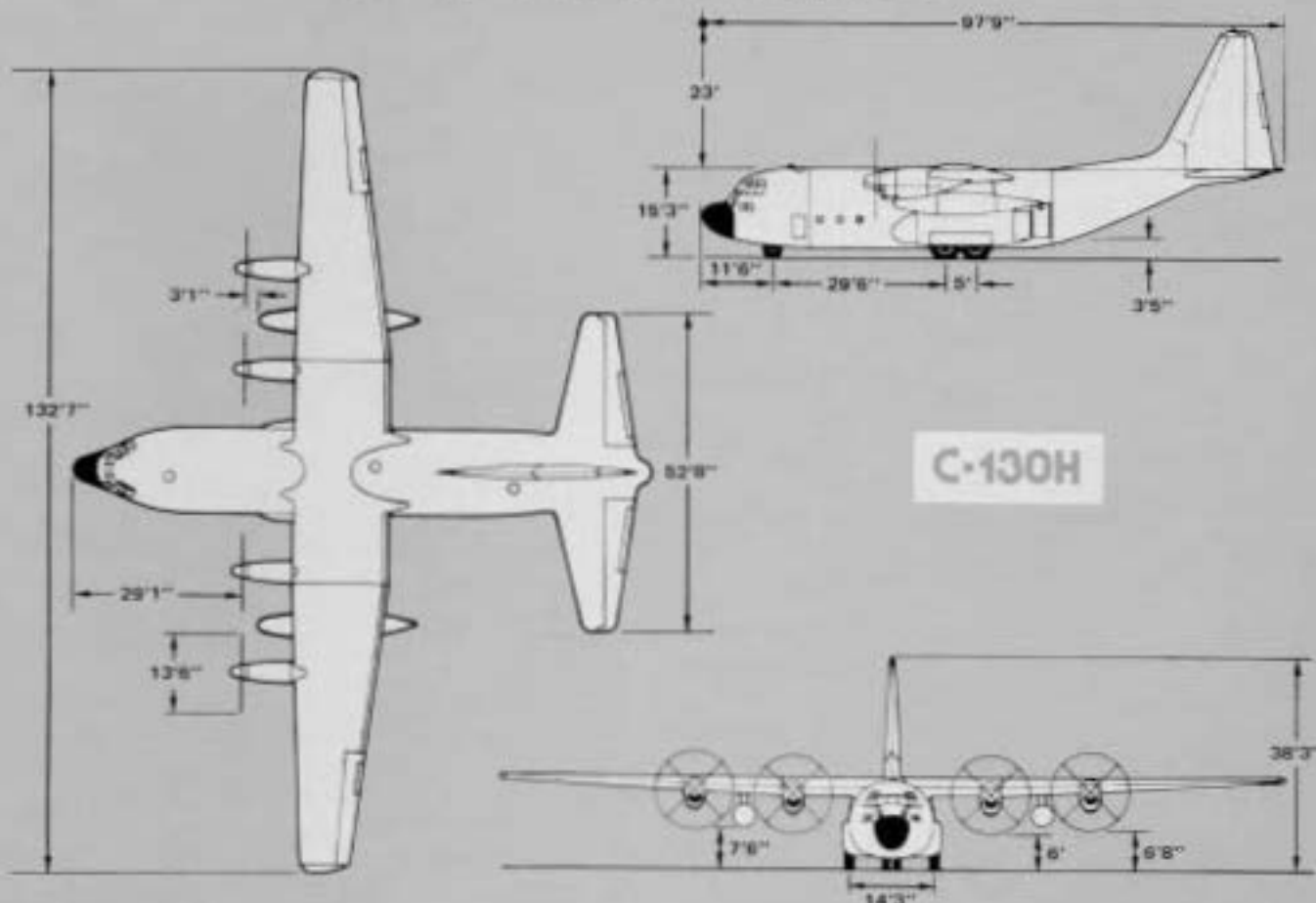

Fact Sheet

C-130H and L-100-30

Specifications and Systems

WEIGHTS

	C-130H	L-100-30
Operating, equipped	74,078 lb	72,943 lb
Maximum payload @ 2.5 g	43,274 lb	52,057 lb
Takeoff:		
Maximum	155,000 lb	155,000 lb
Maximum emergency overload.	175,000 lb (not applicable)	
Landing:		
Maximum	130,000 lb	135,000 lb
Maximum @ 5 fps sink rate	155,000 lb (not applicable)	
Maximum emergency overload @ 5 fps sink rate	175,000 lb (not applicable)	

CARGO COMPARTMENT DATA

Total volume, including ramp.	4500 cu ft	6057 cu ft
Width	10.0 ft	10.0 ft
Height	9.0 ft	9.0 ft
Floor length, excluding ramp	41.0 ft	56.0 ft
Ramp length	10.3 ft	10.3 ft
Maximum ramp angle to ground	11.5deg	11.5deg
Floor height to ground, loaded	3.4 ft	3.4 ft
Aft side doors (2). width/height.	3.0/6.0 ft (not applicable)	
Maximum floor loading (local area)	50 psi	50 psi

Tiedowns include 5000-pound rings on ramp and fuselage side walls and 10,000-pound rings on a 20-inch grid pattern in the floor; also, 25,000-pound rings can be installed at selected floor locations.

FUEL CAPACITY (usable)

Internal.	6960 gal	6960 gal
Pylon tanks	2720 gal	2720 gal
T o t a l	9680 gal	9680 gal

The single point refueling rate for both models is 600 gpm; the fuel dumping rate is 500 gpm.

POWER PLANTS

ENGINES - Four Allison turboprops are installed on each Hercules aircraft. C-130Hs have the T56-A-15 model; L-100-30s use the 501-D22A. Each engine has 4910 equivalent shaft horsepower available, but as installed in the airframe, the maximum permissible output is limited to 4200 shaft horsepower at the propeller. The power section has a 14-stage, axial-flow compressor coupled directly to a 4-stage turbine. The engine maintains a constant speed of 100% (13,820 RPM) in flight. A gearbox ratio of 13.54 to 1 converts the high engine RPM to a propeller speed of 1021 RPM. For lower noise levels during ground operations, an engine speed of 72% may be selected.

PROPELLERS Both models are equipped with four-blade Hamilton Standard Hydromatic propellers, 13.5 feet in diameter. These propellers have feathering and reversing capability, and incorporate low-pitch stop and pitch lock features.

AUXILIARY POWER An auxiliary power unit (APU) supplies bleed air during ground operations for starting engines and for air conditioning. It also drives an AC generator. On the C-130H, the APU may be operated in flight to provide emergency AC power.

ASSISTED TAKEOFF - An option available on C-130H models provides fittings for 1000-pound thrust solid fuel units for assisted takeoff (ATO).

AIR CONDITIONING/PRESSURIZATION

Two independently operated air conditioning units provide conditioned air to the cargo compartment and flight station. The air supplied is also used to pressurize the fuselage, maintaining a safe and comfortable cabin environment at high altitudes.

ANTI-ICING/DEICING

Engine bleed air heats wing and empennage leading edges, the radome, and the engine air inlet ducts. Propellers, pitot tubes, and NESA windows in the flight station are electrically heated.

Airframe



The Lockheed Hercules airplane is an all-metal, high wing, long range monoplane of semimonocoque construction. Designed to airlift personnel and/or all types of cargo, the rugged structure of the Hercules is a major factor in its reliability and versatility.

The fuselage is divided into two main sections; the flight station and the cargo compartment. The flight station contains accommodations for the crew, and instruments and controls for the operation of the aircraft. The cargo compartment provides space for palletized, containerized, or bulk cargo; in some models it also can be used to carry passengers.

The cargo compartment on all Hercules aircraft is 108 inches high at the lowest point, under the center wing section, and 123 inches wide between the curbing attached to the floor. The narrowest point, between the

main landing gear wheel wells, measures approximately 120 inches. The cargo compartment length is 492 inches on the C-130H, and 672 inches on the L-100-30. Cargo is loaded through the opening provided by a cargo door and ramp at the aft end of the airplane. The ramp can be put in many positions to allow straight-in loading from a truck, or to permit vehicles to drive directly into the cargo compartment.

The crew normally enters the aircraft through a crew entrance door on the forward left side of the fuselage. This door is manually operated and is counterbalanced to aid in opening and closing. Steps built into the door eliminate the need for a crew entrance ladder.

On the C-130H there are two personnel doors located on each side of the fuselage aft of the main landing gear wheel wells. Some models of the L-100-30 do not have

Left: The spacious C-130H flight station.
Below: Over 6050 cubic feet of load space is available in the L-100-30's cargo compartment.



CARGO COMPARTMENT COMPARISON
Hercules and Super Hercules Aircraft

Aircraft	Length	Width (Max.1)	Height (Min.)	Ramp Length
A C-130H	492 Inches	123 Inches	109 Inches	123 Inches
B L-100-30	672 Inches	123 Inches	109 Inches	123 Inches

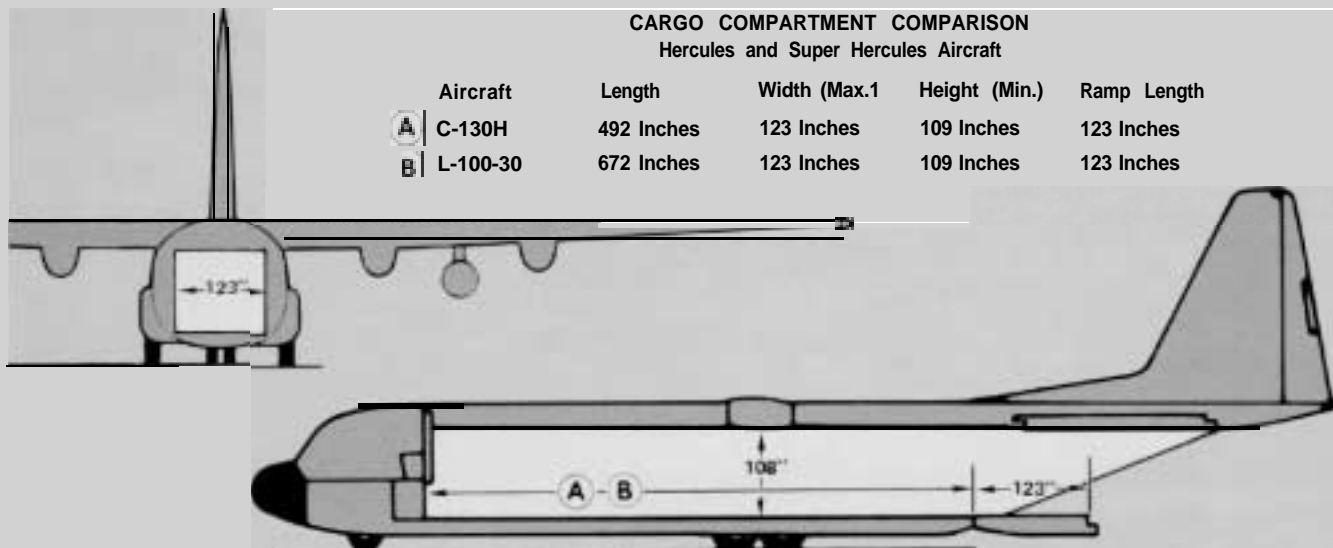

these two doors. Six emergency exits are provided on the aircraft. They include three overhead escape hatches, and an escape panel on the right side of the fuselage forward of the wheel well. Two hinged windows in the flight station can also be used for emergency exit.

Tiedown fittings are installed on the cargo floor, the ramp, and the side walls of the cargo compartment. Five-thousand pound tiedowns are installed on the ramp and the side walls of the cargo compartment. Ten-thousand pound tiedowns are installed on the cargo floor. These are recessed in the floor in a pattern 20 inches on center. Also, there are provisions in the cargo floor for installation of 25,000.pound screw-in tiedown fittings.

At customer request, the Hercules aircraft can be provided with a cargo handling system to allow fast cargo handling and delivery by the use of cargo pallets.

Ground Handling – Normal towing of the Hercules is accomplished by nose gear towing. When the airplane is to be towed over rough or soft terrain, main gear towing is used. Control locks, straps or ties are not used on the Hercules, and none should be installed. The rudder, elevator, and aileron hydraulic boost packages act as hydraulic snubbers and prevent any flutter of the control surface.

8



INSIDE THE C-130H:

This simplified cutaway shows major structures.

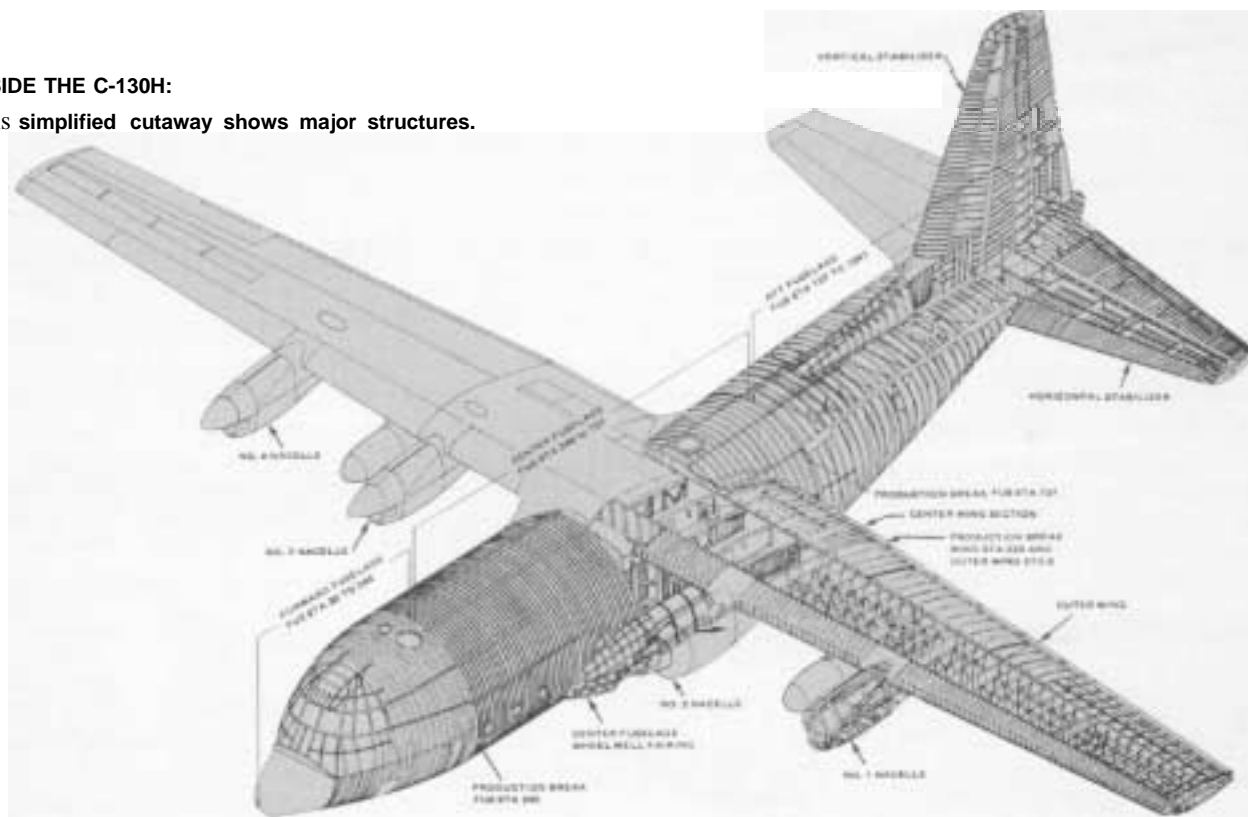

Fuel System



C-130H and L-100-30 aircraft are available with several optional fuel tank arrangements. Individual operators may specify the configuration which is best suited to their particular requirements when the aircraft is ordered.

Fuel Tanks

The basic configuration provides four main integral wing tanks, two in each outer wing. The main tanks are numbered 1 through 4, from left to right. The outboard tanks, numbers 1 and 4, have a capacity of 1340 gallons of usable fuel each. The inboard tanks, numbers 2 and 3, will each hold 1230 gallons. This yields a total capacity of 5140 gallons of usable fuel for all main tanks.

The aircraft's range may be extended by the use of additional fuel tanks. Space is available in the center

wing section for the installation of two auxiliary fuel tanks, one in the left center wing section and one in the right. Each of these tanks consists of three bladder-type cells. The three cells are interconnected to form a single assembly that will hold 910 gallons of usable fuel. Including both auxiliary tanks and the four main tanks, the internal capacity of Hercules aircraft in terms of usable fuel comes to 6960 gallons.

External tanks can extend the range still further. Two external tanks are used on C-130H and L-100-30 aircraft. They are of metal construction and are mounted on pylons under each wing between the engines.

Each of these external tanks have a capacity of 1360 gallons of usable fuel. The external tanks are not jettisonable, but they can be removed for maintenance or if a change in normal mission requirements makes them unnecessary.

The most popular configuration includes the full complement of internal and external tanks. It gives the Hercules a total usable fuel capacity of 9,680 gallons and true long-range mission capability.

Fuel System Features

In addition to the tanks and associated plumbing, the fuel system incorporates a fuel crossfeed system, a single point refueling (SPR) and defueling system, and a fuel dumping system.

The system provides the proper fuel flow for the four engines and also for the auxiliary power unit (APU). Each engine may be supplied either from its associated main tank, or through the crossfeed manifold from any other tank. On current production aircraft, the APU is supplied fuel directly from Number 2 main wing tank.

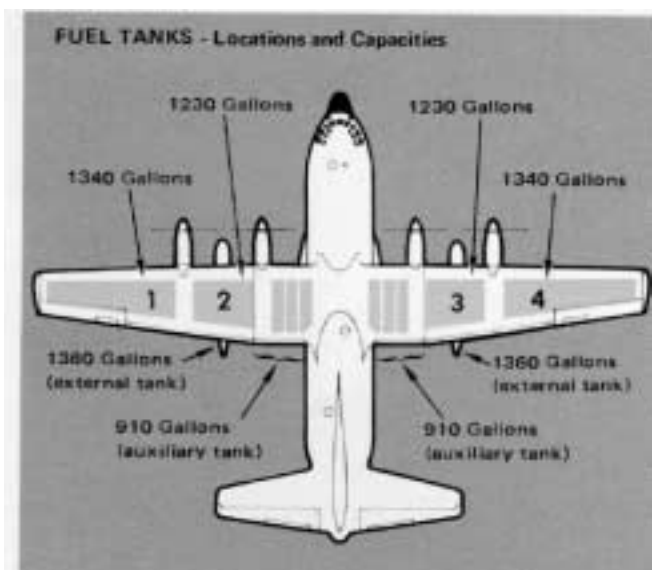

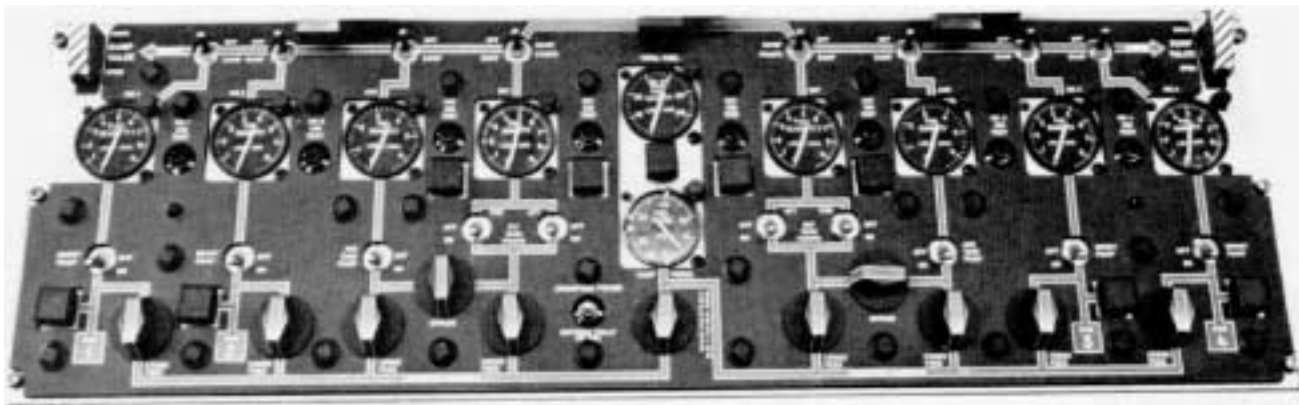

Fuel management panel -flight station overhead control panel

Boost Pumps

Fuel will feed under gravity pressure from each of the main tanks to the nearest engine, but all of the tanks are equipped with boost pumps. The boost pumps are enclosed in surge boxes which ensure that the pumps will be supplied with fuel at all aircraft attitudes. The internal tanks have one boost pump each; the external tanks two each. All pumps operate on three phase, 400 Hz, 11 5/200 volt AC power.

Fuel Management

- 10 Fuel system management during flight is accomplished from the main fuel control panel, located overhead in the flight station. It contains tank quantity indicators, a cross-feed manifold pressure indicator, boost pump switches, crossfeed valve switches, dump switches, and system warning lights. The fuel feed from all tanks to the engines is controlled from this panel.

Refueling and Defueling

The aircraft is normally fueled and defueled from the SPR adaptor in the right aft wheel well fairing. On the ground, any or all tanks can be filled or emptied as needed through the SPR receptacle and associated manifolds, and fuel can also be transferred from tank to tank. It is not possible to transfer fuel during flight, however.

Refueling is controlled at the SPR panel, located just above the refueling receptacle. For defueling or fuel transfer, the controls on the SPR panel are used in conjunction with those of the main fuel control panel in the flight station.

While all tanks are ordinarily filled from the SPR receptacle, the main tanks may be refilled separately through filler ports in the tops of the wings. The external tanks are also equipped with filler ports, located near the top of

RIGHT WING FUEL SYSTEM PLUMBING

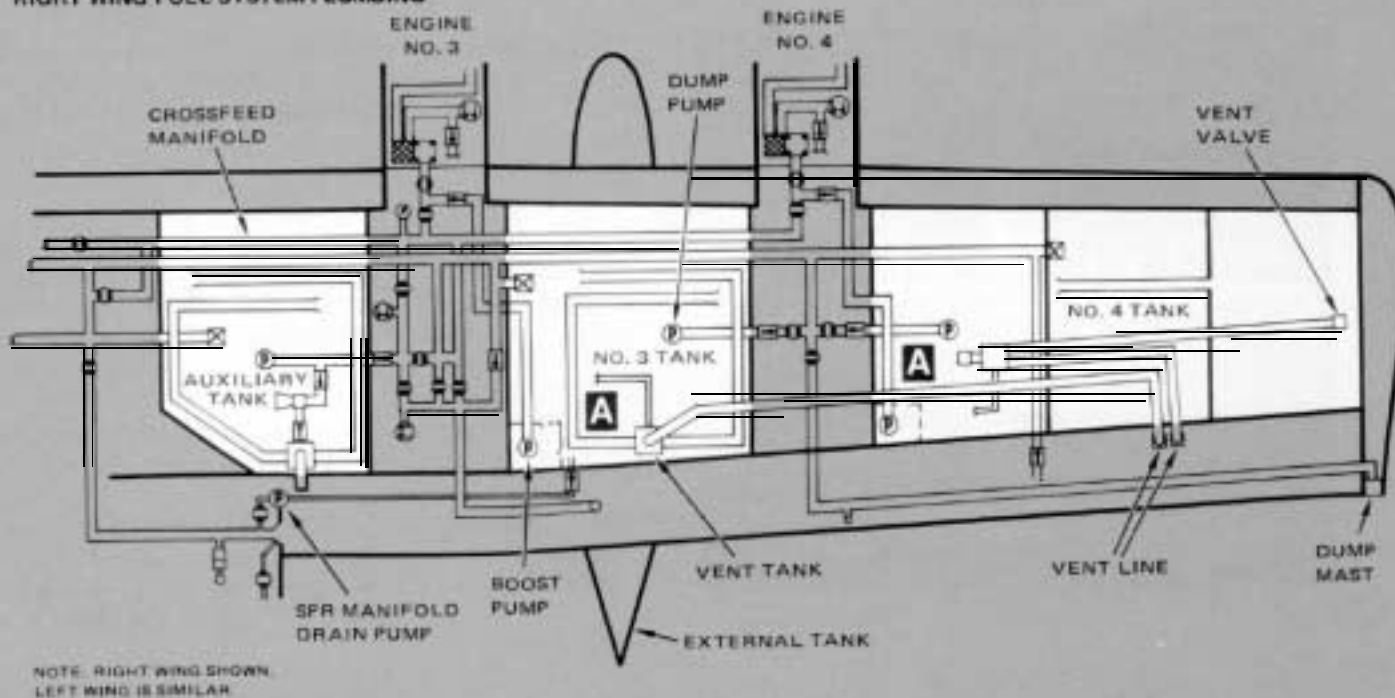

each tank on the left side. The auxiliary tanks can only be serviced through the SPR system.

Fuel Dumping

Hercules aircraft are equipped with a fuel dumping system to enable the flight crew to jettison unneeded fuel in an emergency. A dumping manifold is provided in each wing which will accept fuel from any or all tanks on either side. The manifold conducts the fuel to a dump mast in the wingtip where it exits the aircraft. All except about 300 gallons of fuel in each of the main tanks can be dumped overboard.

The main tanks have integral pumps specifically for dumping. The left and right auxiliary tanks use the same pump both as a boost pump and a dump pump. The aft boost pump in the external tanks is used for dumping, but the forward boost pump can also be switched on to increase the dumping rate.

Tank Venting

The fuel tanks are vented to the atmosphere in order to equalize pressure differences which develop as a natural consequence of changes in altitude and temperature. The inboard main tanks and auxiliary tanks have wrap-around venting systems which consist of open-ended lines that encircle the interior of the tanks. The outboard main tanks are vented through two float-controlled valves in each tank.

Both types of venting systems vent air overboard through vent drain tanks that collect and store any fuel that may enter the lines. When the boost pumps are in operation,

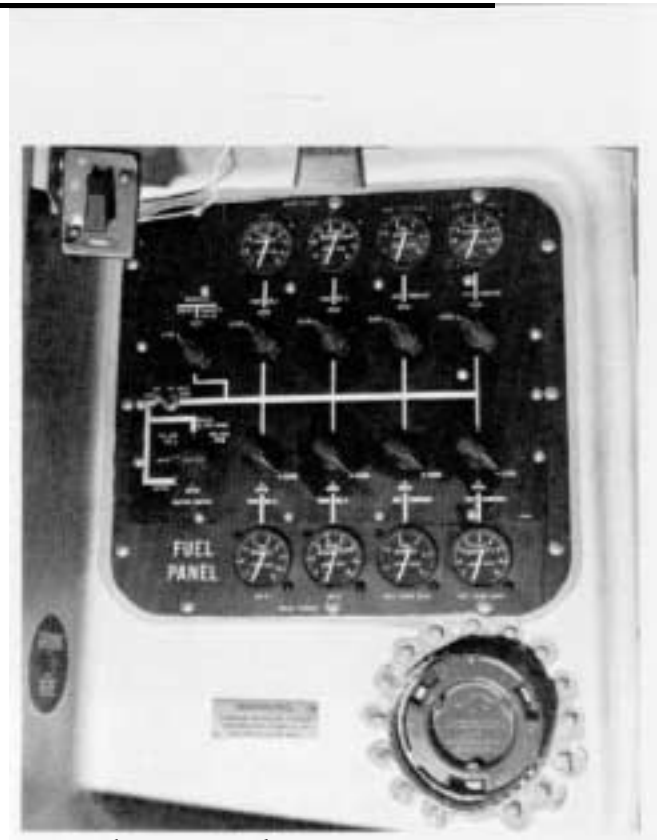

SPR panel and receptacle – aft right wheel well fairing.

fuel which may have accumulated in the vent tanks is automatically returned to the tank of origin.

Each of the external tanks is vented to the air through a single vent line that leaves the tank through the forward part of the pylon and opens to the atmosphere at the trailing edge of the wing.

Fuels

The engines and fuel systems of Hercules aircraft were designed with both maximum efficiency and operational flexibility in mind, and many different grades of liquid hydrocarbon fuels have been employed successfully under emergency conditions. In general, however, best results in terms of performance and engine life may be expected when commercial fuels designed to meet commercial specification ASTM D165.5 (Jet A, A-1, B) or military fuels manufactured to meet military specification MIL-J-5624 (JP-4, JP-5) are used.

Sealants, a polyurethane coating, and a built-in water removal system protect the main tanks against corrosive contaminants sometimes found in fuels. The water removal system is designed to draw a portion of the fuel required for engine operation from between the lower wing panel risers whenever the boost pumps are operating. Any water which may be present is thus mixed with fuel and vaporized in the engine. This ensures the continual removal of water from the low points of the tanks and helps to reduce the possibility of damage caused by water-induced corrosion and microbial attack.

A WATER REMOVAL SYSTEM

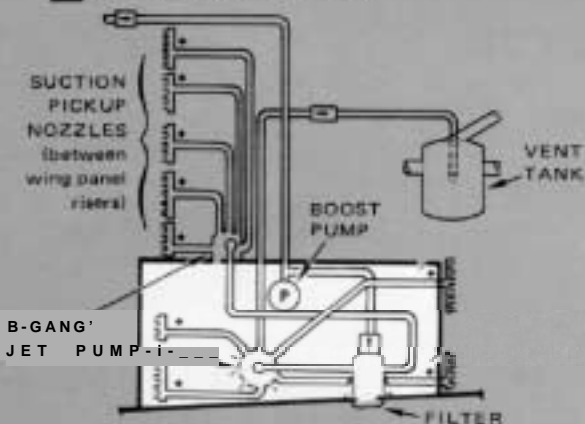

PYLON TANK PLUMBING

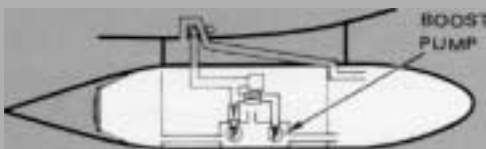

Power Plant Propellers and the APU



Each C-130H or L-100-30 aircraft is powered by four Allison turboprop engines with four Hamilton Standard 54H60-117 propellers. The engines installed in C-130Hs bear the military (USAF) designation T56-A-15; in L-100-30s, a commercial version of the same power plant, the 501-D22A, is used. The differences between the two models are minor, and for most purposes they may be regarded as identical.

- 12 The T56-A-15/501-D22A is one of the most successful aircraft engines ever built. Dependable and efficient, the present design is the well-refined product of many years of testing and field use in the Hercules and other aircraft. The basic engine weighs only about 1850 pounds; yet it is capable of developing 4910 equivalent shaft horsepower* under standard day conditions -- almost 2.7 horsepower per pound of weight. Of course, as installed in Hercules aircraft, the maximum rated horsepower of the engine is never used. The output of each engine is limited to 19,600 inch-pounds of torque (4200 shaft horsepower at the propeller) to extend the service life of the airframe.

Three main assemblies make up this power plant: a power section, a torquemeter assembly, and a reduction gear assembly. The power section is the heart of the system; it is the gas turbine engine where fuel is burned and power developed. The torquemeter assembly is essentially an instrumented extension shaft that connects the power section to the reduction gear assembly and provides a means by which the output of the power section may be measured.

The reduction gear assembly, or reduction gearbox, as it is sometimes called, has a key function. It changes the high RPM delivered by the gas turbine power section to a more usable value. When the power section of the engine is operating at its normal rated speed, it is turning at 13,820 RPM. This is much **too high a speed** for any propeller,

so the reduction gear train is employed to reduce it to 1021 RPM, a more suitable speed for efficient propeller operation. The total reduction ratio is 13.54 to 1, accomplished in two stages in the reduction gearbox.

These Allison turboprops are designed to operate as "constant speed" engines. That is, the engine turns at 100% of its design speed during most phases of normal operation. Changes in power requirements encountered both in flight and on the ground are met by changing propeller pitch and fuel flow, not engine speed. Automatic electrical, mechanical, and hydraulic controls in the propeller adjust propeller pitch very precisely to ensure that 100% RPM is maintained.

ALLISON T56-A-15/501-D22A

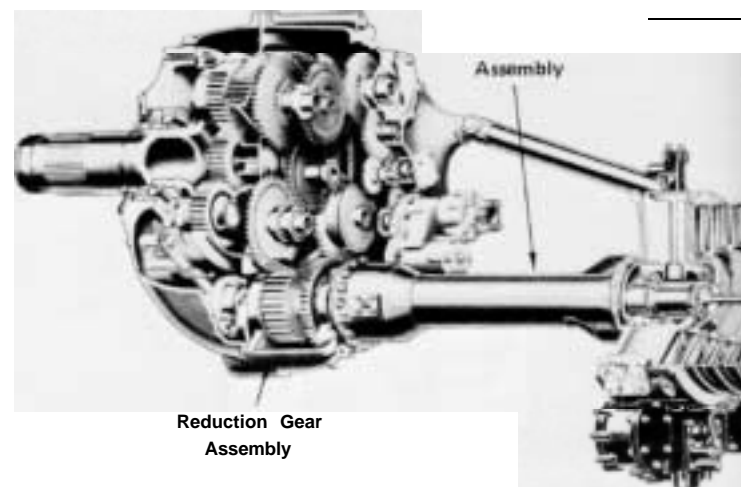

* The equivalent shaft horsepower of a turboprop engine is the shaft horsepower it develops, plus the thrust (expressed in horsepower) obtained from the jet action of its exhaust.

The constant-speed feature allows the power section of the engine to maintain its most efficient speed. It also offers important operational advantages: Since the engine is always operating at 100% of its rated speed, response to rapid changes in power demands during takeoff, landing, or in emergencies is almost instantaneous. This contributes to the outstanding safety record of Hercules aircraft.

Engine control, from the pilot's standpoint, is unusually simple and straightforward. A single throttle lever provides coordinated control over the operation of each engine's propeller, fuel system, and electrical system. Much of the pilot's work is done for him by electronic circuitry, but since the devices which control propeller pitch and fuel metering are fundamentally mechanical in nature, the engines can still be controlled safely even if an electronic component should malfunction in flight. With a little extra attention to throttle settings and engine instruments, in most cases the flight could be completed as scheduled.

The throttle is linked through a coordinator to the fuel control system which meters the fuel for engine power requirements. Under normal conditions in flight, the operation of the engine is controlled automatically at any given power setting. Once the power setting is established by the throttle position, an electronic fuel trimming system maintains power at a constant value by monitoring the temperature at the turbine inlet of the power section and initiating any necessary corrections in fuel flow.

Even when engine and propeller loads are increased or decreased, there is no change in RPM. Control of propeller

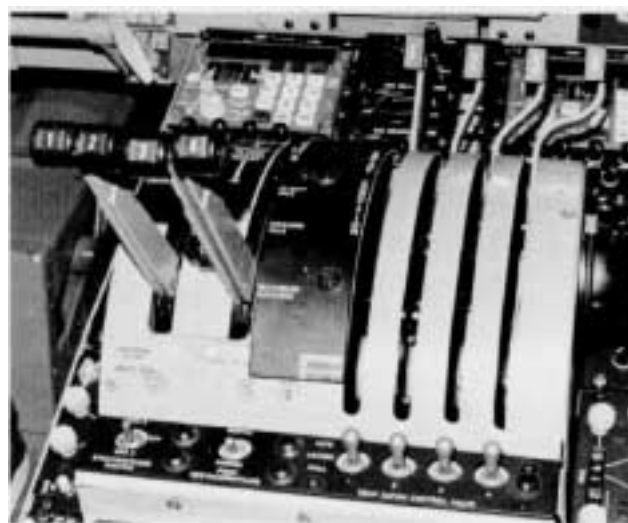

Engine control quadrant – flight station.

pitch, and consequently of engine RPM, is maintained primarily by mechanical governors in the propellers. However, this mechanical system is augmented and made more precise through the stabilizing action of an electronic device known as a Synchrophaser.

The Synchrophaser is also able to keep three engines turning with constant propeller blade positions relative to the fourth, which is called the master engine. The propellers can thus be maintained in a "phase" relationship which will yield the lowest overall noise and vibration levels. An additional circuit known as the throttle anticipator acts to prevent fluctuations in propeller speed during rapid throttle movements.

The engine throttles and condition levers are mounted in a quadrant on the flight control pedestal between the pilot and co-pilot. The throttles are located to the left of the condition levers and are used to make the desired power settings. The throttle quadrant is marked for different operating conditions from maximum reverse on the ground to maximum power in flight.

The position of the condition levers determines the operating mode of the engines. The start and shutdown circuits are controlled by the condition levers, as is feathering and unfeathering of the propellers.

Feathering is also accomplished when the fire emergency control is used. When a fire emergency handle is pulled, circuits are energized to isolate the nacelle from liquids and gasses, to feather the propeller, to arm the fire extinguisher system, and to position directional control valves which route the extinguishing agent to the affected engine. Then a switch movement suffices to discharge the extinguishing agent.

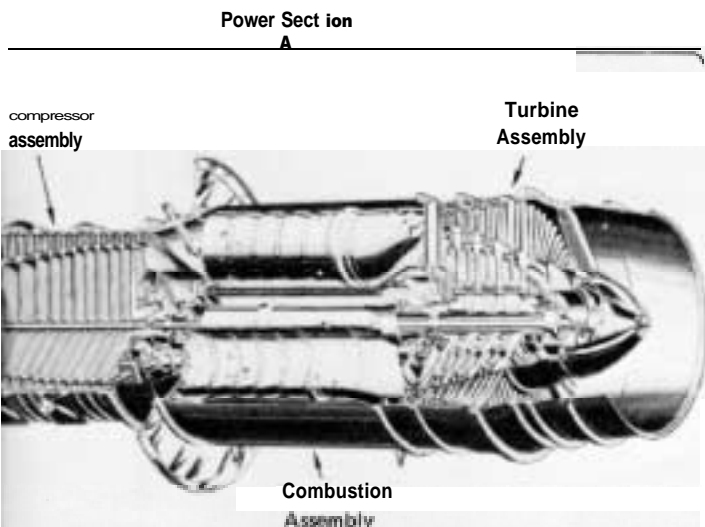

Courtesy Of Detroit Diesel Allison

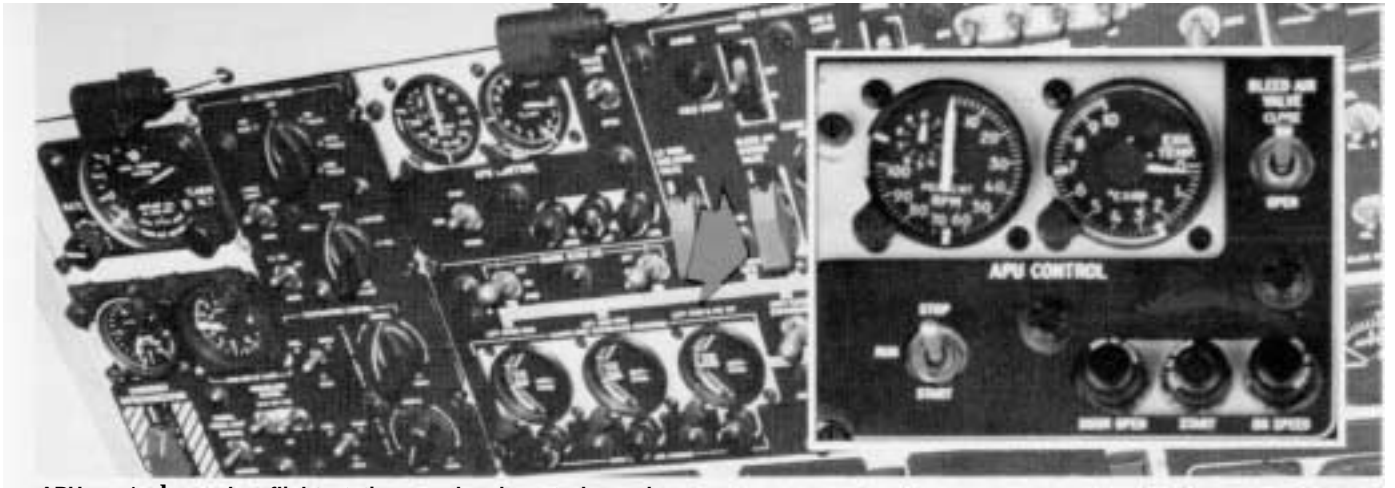

APU control panel – flight station overhead control panel.

Auxiliary Power Unit

The auxiliary power unit (APU) installed in the front left wheel well fairing, provides the system support necessary to make the airplane self-sustaining in its operations. As a source of bleed air pressure, the APU can be used to start engines and to operate the air conditioning. The APU also provides shaft power to drive a 40 KVA AC generator.

14

External power or battery power can be used to start the APU. A three-position (STOP, RUN, START) toggle switch located on an overhead panel in the flight station controls the operation of the APU. When the APU control switch is placed in the RUN or START position, power is supplied to open the APU inlet door. The inlet door is powered through contacts of the auxiliary touchdown relay. The door opens approximately 35 degrees on the ground and, in the case of the C-130H, 15 degrees in flight

Auxiliary power unit – forward left wheel well fairing.

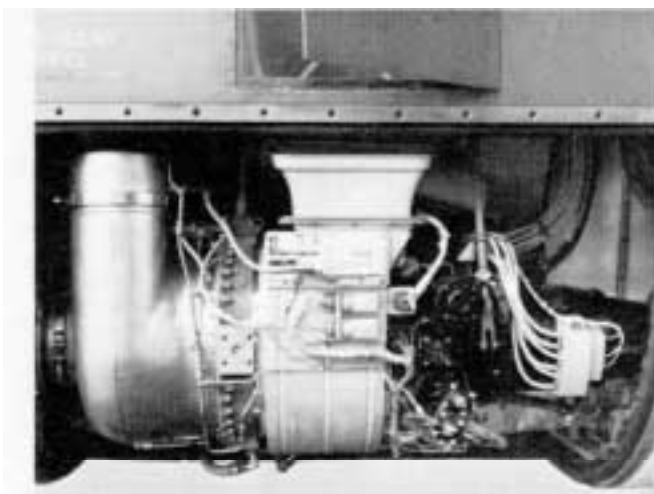

Holding the APU control switch in the START position provides power to the door. When the door opens to the 15-degree position, the start and holding relays are energized. This opens the wing tank shutoff valve and energizes the starter. Fuel is gravity fed from No. 2 main fuel tank through the motor-operated shutoff valve and the APU fuel control to a solenoid-operated fuel valve. An oil pressure switch provides a circuit for the fuel valve and the ignition. The start relay remains energized until the circuit is broken by the APU's 35% speed switch or by moving the control switch to the STOP position.

When the switch is released from the START position, spring tension moves it to the RUN position. In this position, all circuits to the APU's various automatic controls are energized. These oil-pressure and speed-sensitive switches control their respective circuits to accomplish the starting and running of the APU. Normal governing operating speed is 42,000 RPM.

On current production C-130H and L-100-30 aircraft, the APU can be operated on the ground to supply bleed air and/or electrical power. In the C-130H only, the APU may also be used as an electric power source in flight. The APU will operate when on speed at altitudes up to 35,000 feet, but it may not be possible to start it at altitudes above 20,000 feet because of the low atmospheric density.



Pneumatic Systems

There are three important systems on Hercules aircraft that are classified as pneumatic systems. They are the engine starting system, the environmental control system, and the oxygen system. The first two systems utilize hot compressed air – usually referred to as bleed air – as their power source. The oxygen system works quite differently. It depends upon internally stored compressed or liquified oxygen for its operation.

Bleed Air Sources

Let us first examine how the bleed air which is required for the engine starting system and the environmental control system is supplied. During normal aircraft opera-

tion, these systems are powered by compressed air which is “bled” (hence the term bleed air) from the 14th stage of the engine compressors. Each engine can provide approximately 155 pounds per minute (ppm) air flow at 635°F and 125 pounds per square inch gage pressure (psig). The combined output of the four engines is more than enough to supply all of the pneumatic requirements of the airplane.

When the aircraft’s engines are not running, bleed air can be supplied by the onboard auxiliary power unit (APU) or a ground air compressor. Either of these sources can provide 155 ppm of air at 435°F and 40 psig. This is sufficient to start one of the main engines or power the cabin air conditioning units during ground operations.

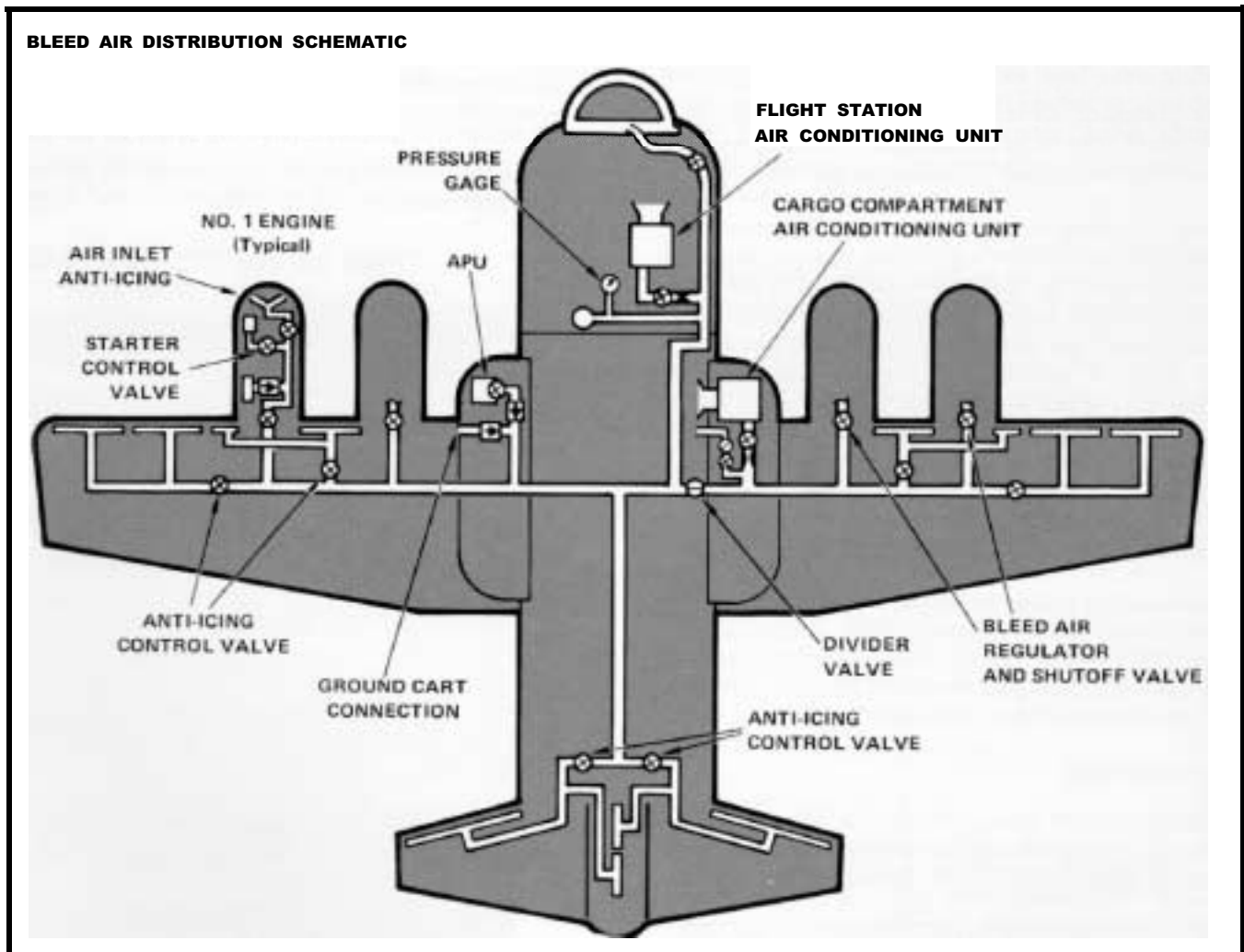



Above Left: Bleed air regulator and shutoff valve – engine nacelle. Right: Cargo compartment air conditioning unit – forward right wheel well fairing.

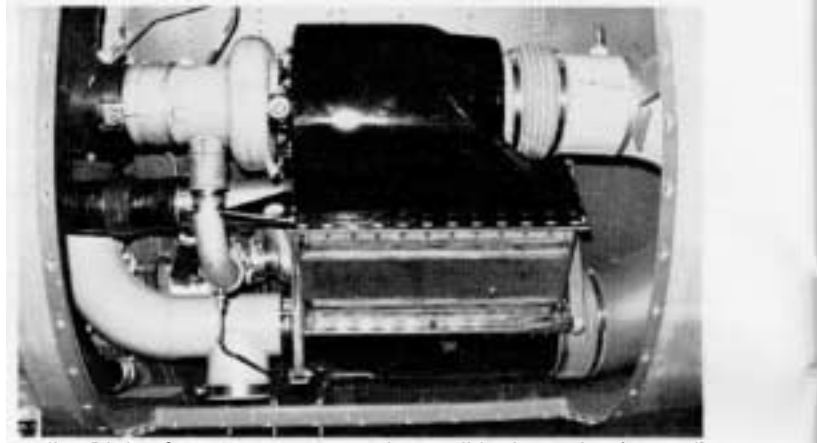

The bleed air sources in the aircraft are connected to the pneumatic systems and to each other by stainless steel ducts. The main duct, which extends across the front beam of the wing and interconnects the bleed air outlets of the engine compressors, is called the bleed air manifold. A bleed air regulator and shutoff valve in each nacelle controls the bleed air flow to and from individual engines and the bleed air manifold.

Engine Starting System

16

The pneumatic starters used in Hercules aircraft are a specialized type of air turbine motor. One of these units is mounted on the back of each engine gearbox.

When the starter switch for an engine is operated, the engine's starter control valve opens and compressed air from the bleed air manifold is admitted to the starter turbine. As the turbine begins to rotate, helical spline action causes the starter to engage the engine through the reduction gear train. The starter then drives the engine to a speed which is fast enough (about 60% of normal operating RPM) for internal combustion to continue the acceleration. At this point the starter switch is released, which closes the starter control valve and cuts off the supply of bleed air to the turbine. The starter then disengages and coasts to a stop.

Environmental Control System

The environmental control system includes three main subsystems: the air conditioning system, the pressurization system, and the anti-icing system.

Air Conditioning

Hercules aircraft have two separate air conditioning systems, one for the cargo compartment and one for the flight station. Identical units are used in both systems.

The main components of the cargo compartment system are located in the forward part of the right wheel well;

those of the flight station system are under the flight station floor on the right side of the aircraft.

The two systems may be used individually or simultaneously. Each can supply approximately 70 ppm of conditioned air through its distribution ducts at sea level. This air is used to maintain the desired temperature, provide cabin pressure, and furnish ventilation to the cabin. When they are operated simultaneously, the two systems can maintain 75°F inside the cabin with the outside temperature anywhere in the range from -65°F to +100°F.

The air conditioning units are powered by bleed air. In typical operation, air is ducted from the bleed air

Right side view of L-100-30 shows inlets for (1) conditioning units. The pressurization outflow valve is



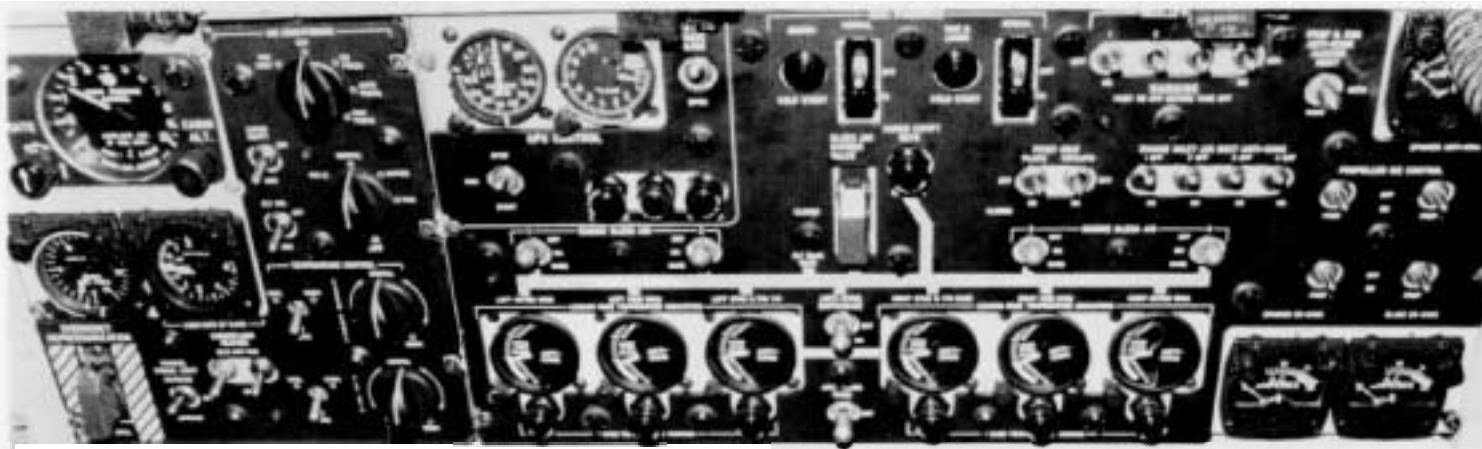

Anti-icing system control panel ~ flight station overhead control panel.

manifold to a flow control and shutoff valve which regulates the flow of air. On its way to the cabin, the air passes through a cooling turbine, a temperature control valve, or both. The hot bleed air entering the cooling turbine is first reduced in temperature by the flow of ram air through a heat exchanger. Additional cooling of the bleed air is accomplished by expansion of the air through the cooling turbine. Since cooling causes moisture in the air to condense, the air is then ducted into a water separator where about 70% of the free moisture is removed.

When the air leaves the water separator, it is mixed with warm air flowing through the temperature control valve to furnish air to the cabin at the temperature required.

The operation of the temperature control valve is controlled by impulses from a temperature control box as directed by signals from a temperature control thermostat and other sensors.

Pressurization

Bleed air climatized by the air conditioning system is the air source for cabin pressurization. Hercules aircraft use a normal maximum differential pressure of 15.18 inches of mercury. This allows sea level cabin altitude to be maintained until the aircraft reaches an altitude of about 18,500 feet. Safe, comfortable cabin altitudes of 8000 feet or less can be maintained all the way up to 35,000 feet.

Cabin pressure is normally controlled automatically. However, the system is designed to permit the operator to select desired cabin altitudes and rates of change. Pressure limiting protects the aircraft structure from excessive differential pressure in the event of a malfunction of the altitude control mechanism or human error in operating the system.

The major components of the pressurization system include an outflow valve, a pressurization controller, and a safety valve. The outflow valve is used to regulate cabin pressure by controlling the air flow out of the cabin. The pressure controller regulates the position of the outflow valve during automatic pressurization control. The safety valve protects the aircraft against excessive positive or negative pressure differentials and serves as a backup depressurization device in case of malfunction by the outflow valve.

Anti-icing

Anti-icing on Hercules aircraft is accomplished by directing hot air from the bleed air manifold to surfaces such as the wings, empennage, engine inlets, and radome where ice accumulation may occur.

cargo compartment and (2) flight station air conditioning located behind the louvers (3).



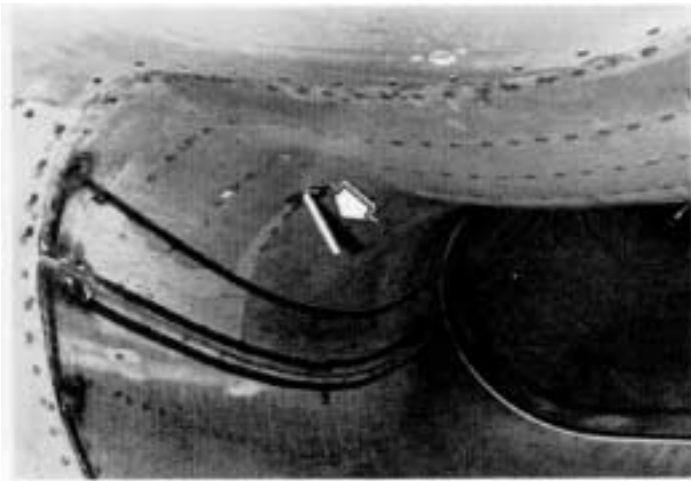

**Engine
air inlet
ice detector.**

The wing and empennage surfaces are divided into six sections for anti-icing purposes. Individual anti-icing valves control the supply of hot air to each section. Two anti-icing valves are located in each wing, and two in the empennage.

The leading edges of the wings and empennage are double walled. When anti-icing is selected for a particular section, hot air at 500°F is routed through the anti-icing valve and an ejector assembly and into spaces between the walls. Ambient air within the leading edge is mixed with the hot air, lowering its temperature to around 200°F. The air mixture then circulates through the passages between the inner and outer skins, heating the leading edge and keeping it warm enough to prevent ice from forming.

18

LOX converter – nose wheel well, C-130H.

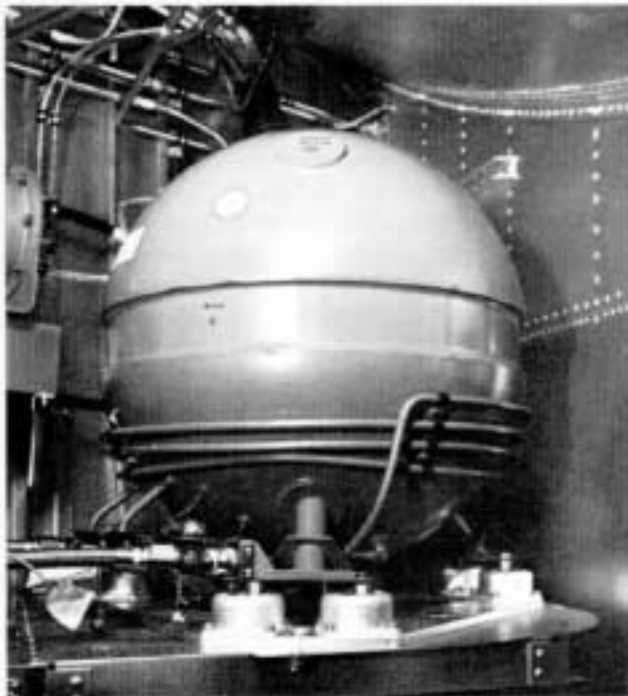

Hot bleed air is also used to control icing of the engine inlets and the radome. The engine inlets are equipped with ice detectors that automatically turn on the bleed air flow when icing conditions are present. Anti-icing for the radome may be controlled manually or automatically. If automatic operation is selected, control of radome anti-icing is coupled to the engine inlet ice detection circuits. In this mode of operation, bleed air flow through the radome begins whenever anti-icing for the engine inlets is initiated.

Oxygen System

The C-130H uses a liquid oxygen (LOX) system. A 25-liter converter in the nose wheel well provides gaseous oxygen to ten pressure-demand type regulators located at crew stations in the aircraft. When fully serviced, the LOX converter has a minimum supply of 96 man-hours.

The airplane is also equipped with four portable oxygen bottles which can be serviced from either the aircraft's oxygen system or ground servicing equipment.

L-100-30 aircraft use a gaseous oxygen system. A single 1800 psi cylinder supplies four pressure-demand type regulators on the flight deck. The cylinder will supply a minimum of ten man-hours of oxygen when fully serviced. In these aircraft, one portable oxygen bottle is provided in the cargo compartment.

**SERVICE
NEWS**

the Hydraulic Systems



Auxiliary hydraulic system reservoir and pump.

pressures is made of corrosion-resistant steel, while low pressure lines such as fluid return lines and reservoir drain lines are made of an aluminum alloy. Flareless-type fittings, referred to as ERMETO or MS flareless fittings, are used for tubing connections.

The control panel for the hydraulic systems is located on the copilot's instrument panel. The panel contains pressure indicators for each system and for the brake and rudder subsystems. Panel lights indicate low pressure output from the pumps. Switches are provided for pump control and for normal or emergency brake selection.

C-130H and L-100-30 airplanes have three separate 3000 psi hydraulic power systems. They are known as the booster, utility, and auxiliary systems and are used to operate components such as the flight controls, landing gear, and cargo doors. Although the systems are separate, for reasons of safety and system reliability many of their functions overlap to provide a multiple source of hydraulic power for vital operations. (Ref. Figure 1.)

Normally, hydraulic fluid conforming to specification MIL-H-5606 is used in all three hydraulic systems; however, some customers are converting to approved alternative fluids. Hydraulic system tubing subject to 3000 psi

AUXILIARY	UTILITY	BOOSTER
Ground Checkout of Utility System		Elevator
		Aileron
		Rudder
Ramp and Cargo Doors	Flaps	
	Landing Gear	
Emergency Brakes	Normal Brakes	
Emergency NLG Extension	Steering	

Figure 1.

Booster System

The sole purpose of the booster system is to provide hydraulic power to the booster section of the primary

Hydraulic control panel – copilot's instrument panel.



flight control boost units (aileron, rudder, and elevator). For the rudder and ailerons, each hydraulic booster is of a tandem type, i.e., the actuator has twin pistons on a single shaft. Booster system pressure is supplied to one piston and utility system pressure is supplied to the other. The elevator boost package is of a dual type that incorporates two separate piston and actuator assemblies. One piston and actuator system is powered by booster system pressure and the other by utility system pressure. Either hydraulic system alone is capable of supplying the necessary pressure and flow to operate all boost units but at a reduced force level.

Manual operation of the flight controls without any assistance from the hydraulic systems is possible in an emergency. However, substantially increased control forces are required. Under such circumstances, additional control assistance can be gained by manipulation of engine and secondary flight controls.

The boost units for the primary flight controls are designed for efficient operation under varying flight conditions. Under normal flight conditions, the rudder boost

unit operates at reduced pressure (approximately 1300 psi). But when the flaps are extended to or past the 1.5 percent position for low speed flying, diverter valves are actuated to bypass the pressure reducers; then the rudder boost unit operates on the full 3000 psi system pressure.

The dual elevator boost assembly operates at 3000 psi, and the single-tandem aileron boost assembly operates at approximately 2050 psi pressure at all times.

The system includes a reservoir, pumps, filters, an accumulator, low pressure warning system, pressure indicating system, and necessary valves and tubing.

The booster system is powered by engine-driven hydraulic pumps installed on engines No. 3 and No. 4. Each pump is of the variable-delivery demand type and has an output of approximately 8.6 gallons per minute.

The booster system can be operated on the ground by applying external hydraulic power through standard ground test connections in the forward right wheel well; however, the booster system cannot be interconnected to any other aircraft hydraulic system.

20

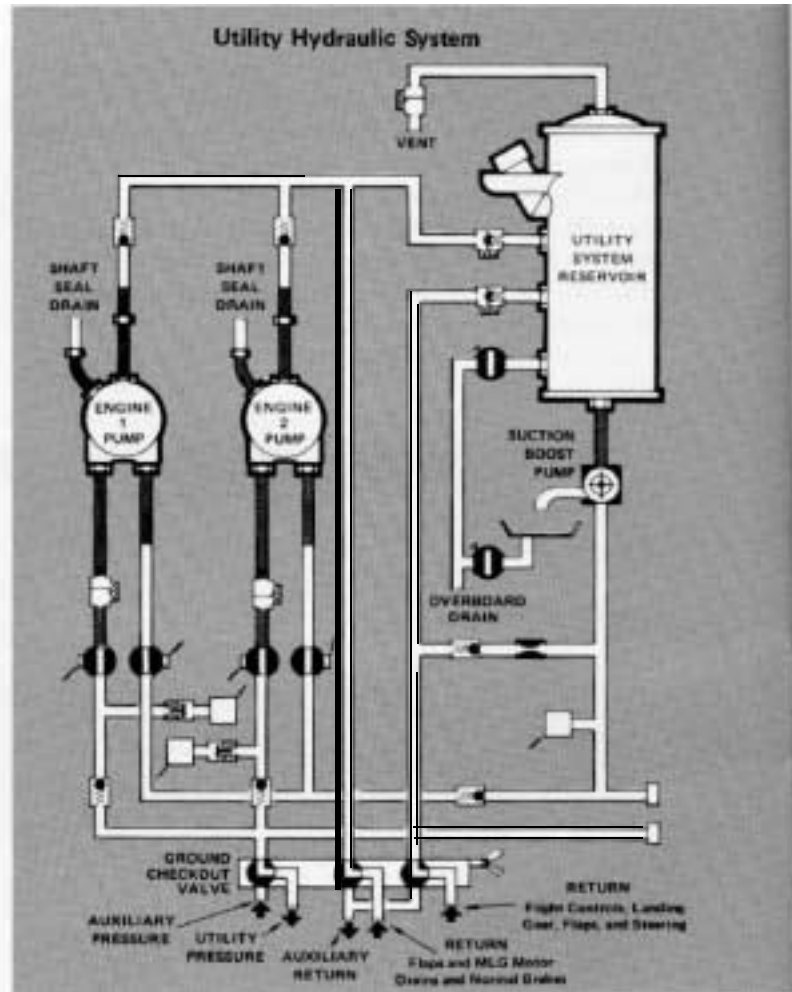
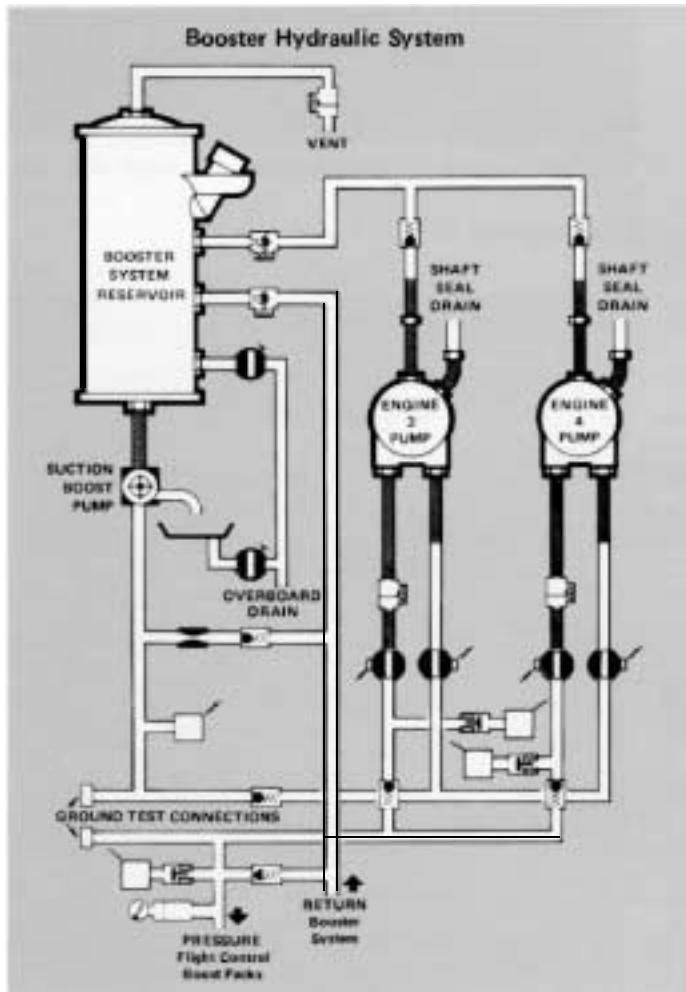

Utility System

The utility system supplies hydraulic pressure to the utility section of the flight control boost units. It is also the pressure source for landing gear extension and retraction, nose gear steering, normal wheel brakes, and wing flaps operation.

The components of the utility system are similar to those of the booster system. The system is powered by hydraulic pumps located on engines No. 1 and No. 2.

Auxiliary System

The auxiliary system is independent of engine operation because it is powered by an AC motor-driven variable displacement pump or by a hand pump. The auxiliary system has several functions. It is the pressure source for operating the ramp and cargo door, emergency nose gear extension, and the emergency brakes.

A ground checkout valve can be used to divert auxiliary system pressure to the utility system. When it is impractical to start the engines and a hydraulic test cart is not

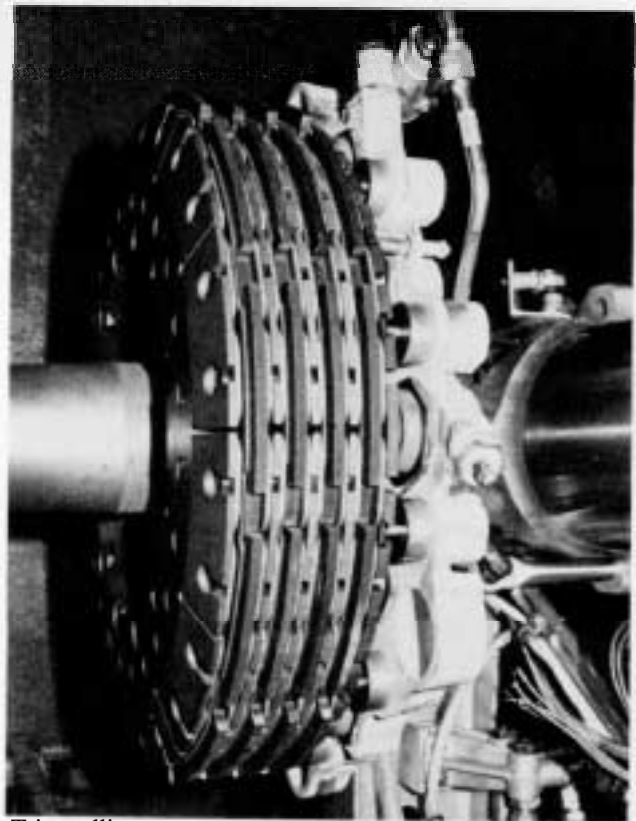

Trimetallic multi-disk brake assembly – main landing gear.

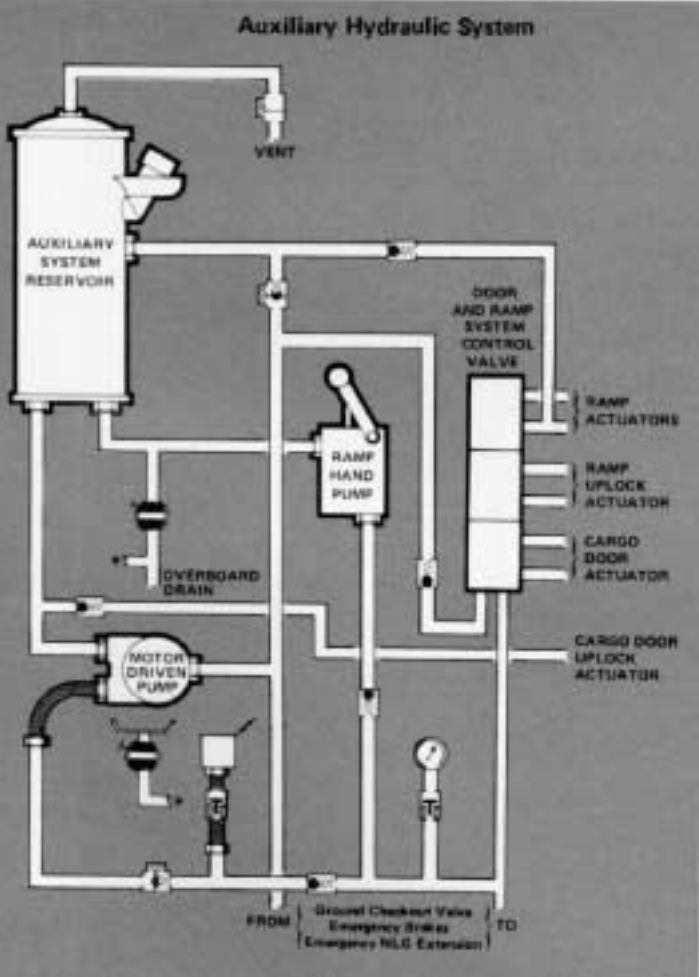

available, this arrangement allows operational checks to be made on components normally powered by the utility system.

Landing Gear

The landing gear is of the steerable, tricycle type, with dual nose wheels and tandem main wheels. The nose landing gear retracts forward and up and is powered by a hydraulic actuator. The main gear retracts vertically into the main wheel wells and is powered by hydraulic motor-driven screwjacks. The landing gear doors are mechanically actuated by rods linked to the landing gear. The utility system provides the hydraulic pressure to extend and retract the landing gear. In the event of utility system hydraulic pressure failure, the main landing gear can be extended or retracted with a hand crank, and the nose gear can be extended by hydraulic pressure supplied by the auxiliary system. The nose wheel tire size is 39 x 13, and the main wheel tires are 56 x 20.

The wheel brake system on Hercules airplanes have a normal system and an emergency system. The brakes are multi-disk units. An anti-skid system ensures optimum braking on all runway conditions.

Electrical System

Electrical system power distribution for the Hercules consists of three systems which are interrelated, but not necessarily interdependent. An unregulated AC system, a regulated AC system, and a DC system provide the electrical power needed to operate the various types of aircraft equipment. Four engine-driven AC generators supply the normal requirements of the aircraft systems. One generator is mounted on the back of the reduction gearbox of each engine. A fifth AC generator, driven by the auxiliary power unit (APU), serves as a standby power source for the essential AC bus. The APU is located in the left main landing gear fairing.

Each of the generators is rated for a power output of 40,000 voltamperes (40 KVA) and a design voltage output of 120/208 volts. The electrical systems of the C-130H and L-100-30 airplanes are similar in most respects; one difference is that on the L-100-30, the APU's generator can be connected to both the essential and main AC buses for ground operation. This allows the airplane to be defueled without the need for external AC power.

Unregulated AC Power

The electrical power produced by the four engine-driven generators and the APU generator is referred to as unregulated AC power. This is because its frequency is dependent upon the speed at which the generators are turning; it is thus in theory "unregulated." In practice, the constant-speed engines used on Hercules aircraft hold the frequency to 400 Hz (+/-20 Hz).

The unregulated AC system is the primary supplier of electricity on the airplane. During normal operation, all other systems obtain power either directly or indirectly from this source.

Regulated AC Power

The regulated AC system has a much more limited function. It supplies single-phase 400 Hz power at 115 volts to the engine electronic fuel trimming circuits and certain instruments during engine start operations, or when other sources of AC power are not available. Power for this system is obtained from inverters energized by the onboard storage battery, external DC sources, or DC current supplied through transformer-rectifier (T-R) units by the unregulated AC system. The frequency in the regulated AC system is 400 Hz (+/-4 Hz).

DC Power

DC power for the aircraft is normally supplied by four T-R units. The T-Rs change three-phase 200-volt power supplied by the unregulated AC or an external AC source to 27.5 volts DC. Each unit is rated at 27.5 volts with a current load of between 5 and 200 amperes.

External Power

External AC and DC power receptacles are located on the left side of the fuselage, just forward of the crew entrance door. The external power circuits use these connections with an interlock circuit that ensures that the ground power source is compatible with the aircraft's

Electrical control panel –
flight station overhead control panel.

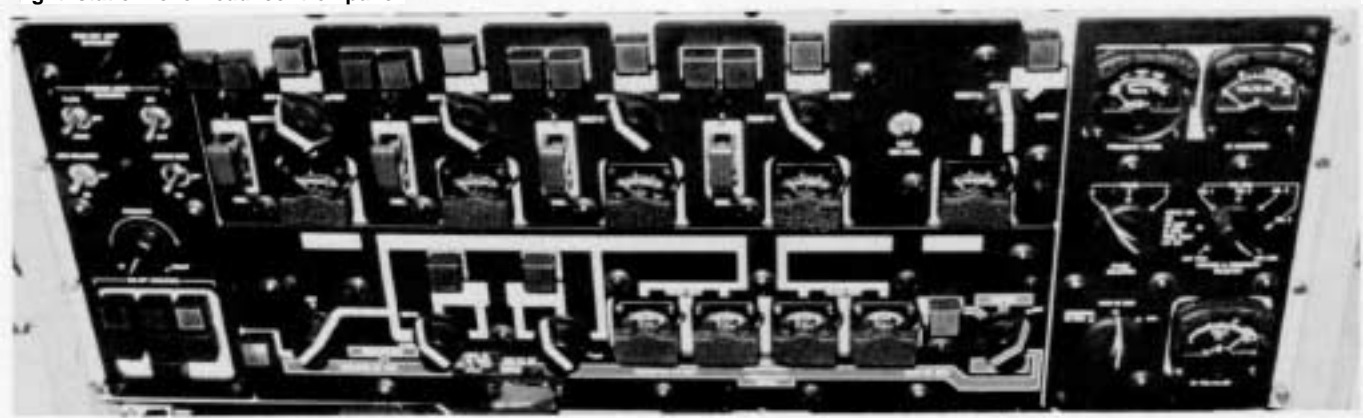

electrical system. The external AC power source can supply energy to all four AC buses. When only AC external power is connected, the DC buses will be energized through the T-R units to supply direct current requirements. If the battery switch is on, external power will charge the battery. Two static ground wires should be connected before external power connections are made.

External DC power can be connected to the aircraft DC buses for ground operations such as starting the APU and checking out the DC circuits. A 24-volt, lead-acid battery is provided to supply emergency power in flight, and also to make the aircraft self-sufficient for operation in remote areas. The battery can be used to start the APU on the ground when other electrical sources are not available. The APU can then provide compressed air for engine starting and AC power to operate other aircraft systems.



Onboard storage battery and external power receptacles-left side forward of crew entry door.

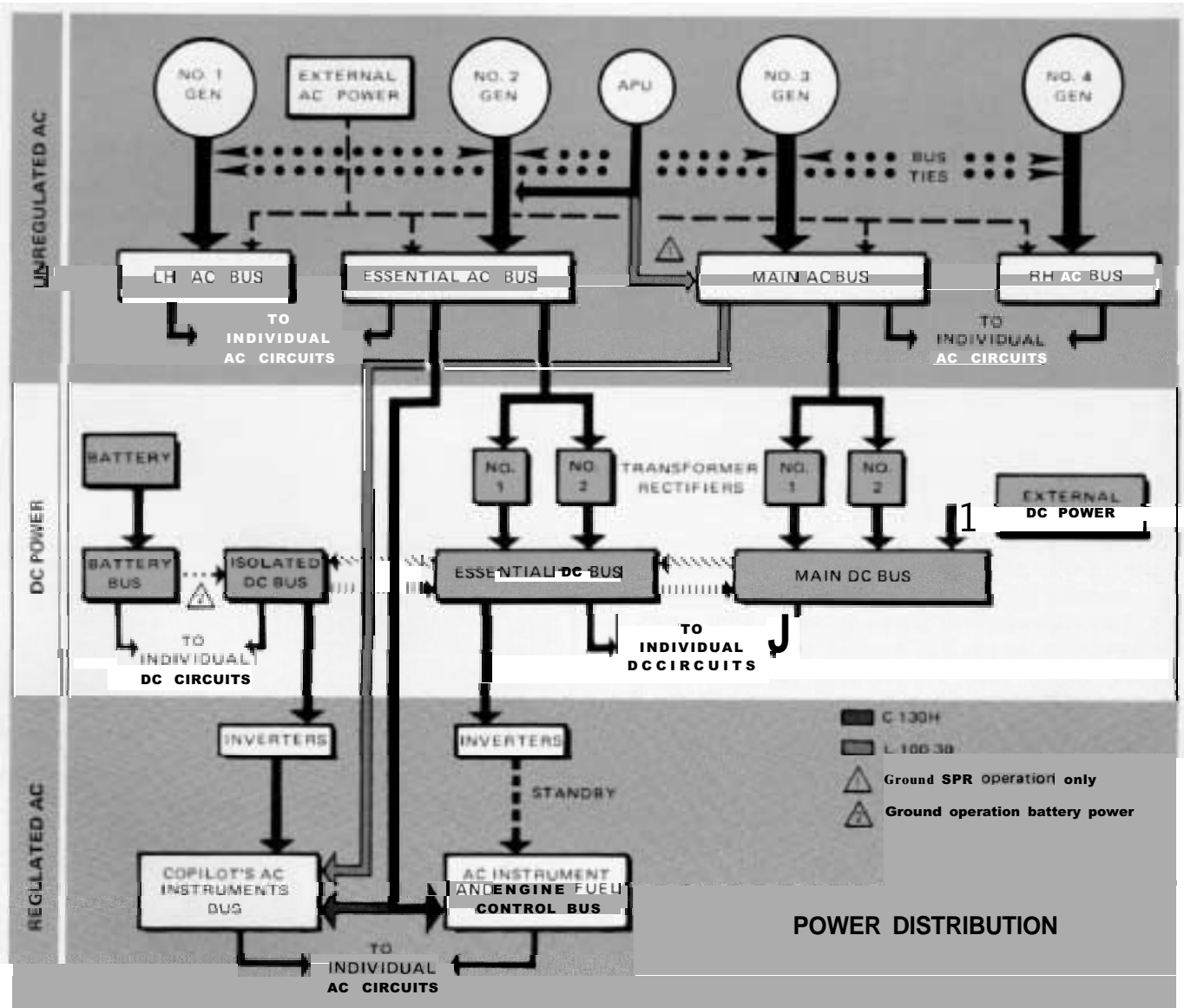



TATTOO

The International Air Tattoo held at RAF Greenham Common, England, on June 23 and 24 proved to be an exceptional air show. Twenty-seven C-130 Hercules aircraft from 15 nations were on display to highlight the Silver Anniversary of the Hercules.

The 15 countries represented were Argentina, Australia, Belgium, Brazil, Canada, Denmark, England, Israel, New Zealand, Norway, Portugal, Saudi Arabia, Spain, the United States and Venezuela.

The Lockheed-sponsored "Contours D'Elegance" trophy for the best-maintained Hercules went to a Royal New Zealand Air Force C-130H from Whenuapai. Runners-up were a C-130D ski Hercules from the New York Air National Guard at Schenectady, and a USAF Military Airlift Command C-130E on rotation to Mildenhall, England. The "Spirit of the Meet" award was won by a U.S. Coast Guard HC-130H rescue and recovery crew from Kodiak, Alaska.

The Lockheed-Georgia Company would also like to congratulate the following personnel, who were honored as outstanding C-130 crewmen: Aircraft Commander – Col. Mohammed Ibrahim Suleman, Royal Saudi Air Force, Jeddah, Saudi Arabia; Co-Pilot – Major Amos Scott, Canadian Forces, Edmonton, Canada; Navigator – Major James Perkinson, 118 Tactical Airlift Wing, Nashville, Tennessee (Tennessee Air National Guard); Flight Engineer – SMSgt. Robert L. Keitt, 317th Tactical Airlift Wing, Pope AFB, North Carolina (on rotation to 313th TAG, Mildenhall, England); Loadmaster – M. Langivandsbraaten, Norwegian Air Force, Gardermoen AB, Oslo, Norway, and Milton R. Pohle, 67th ARRS (USAF), RAF Woodbridge, England; and Crew Chief – Warrant Officer Bruce Peyton, 40th Squadron, Royal New Zealand Air Force, Whenuapai, New Zealand.

The International Air Tattoo is billed as the world's largest military air show. It is held annually to support the RAF Benevolent Fund. Over 200,000 people attended this year's festivities.

NEW HERCULES BOOK

Herk: Hero of the Skies, a new book about the history of the Hercules has just been published. Prepared by



The International Air Tattoo featured Hercules aircraft from 15 countries.

Joseph E. Dabney, the 416-page hardback book is illustrated with 288 photos. Publisher of the international edition is Airline Publications and Sales, Ltd., Noble Corner, Great West Road, Hounslow, Middlesex, TW5 OPA, England. Publisher of the U.S. edition is Copple House Books, Lakemont, Georgia 30552.