



VOL. 1, NO. 2, APRIL - JUNE 1974

SERVICE NEWS

A SERVICE PUBLICATION OF LOCKHEED-GEORGIA COMPANY, A DIVISION OF LOCKHEED AIRCRAFT CORPORATION



SERVICE NEWS

A SERVICE PUBLICATION OF
LOCKHEED-GEORGIA COMPANY
A DIVISION OF
LOCKHEED AIRCRAFT CORPORATION

Editor

Jay V. Roy

Associate Editor

James A. Loftin

Art Direction & Production

Phillip E. Evans

COVER: A unique picture of the first commercial Hercules which was later to become the first -20 model (100 in fuselage extension) This aircraft is now in service with the Philippine Air Force

COMMENTS

Our first issue has received some fine comments, which we appreciate very much. We believe you will find this second issue to be even more useful. We have tried to provide something of interest for everyone – including an article on our Standardized Logistics Management System.

If you have suggestions, criticisms, comments, wish to be put on distribution, or need additional copies, please contact your Field Service Representative or send us a note addressed:

Editor, Service News
Lockheed-Georgia Company
Marietta, Georgia 30063
U.S.A.

Published by Lockheed-Georgia Company, a Division of Lockheed Aircraft Corporation. Information contained in this issue is considered by Lockheed-Georgia Company to be accurate and authoritative; it should not be assumed, however, that this material has received approval from any governmental agency or military service unless it is specifically noted This publication is for planning and information purposes only, and it is not to be construed as authority for making changes on aircraft or equipment or as superseding any established operational or maintenance procedures or policies The following marks are registered and owned by Lockheed Aircraft Corporation “”, “Lockheed”, “Hercules”, and “JetStar”. Written permission must be obtained from Lockheed-Georgia Company before republishing any material in this periodical Address all communications to Editor Service News Department 64.22, Zone 278, Lockheed-Georgia Company, Marietta Georgia, 30063 Copyright 1974 Lockheed Aircraft Corporation.

VOL. 1, No. 2, April-June 1974

CONTENTS

- 3 **Hercules Propeller Control Oil Level Check**
Using the Atmospheric Sump Dipstick
 - 7 **The Standardized Logistics Management System**
A Better Way to Maintain Any High Technology Product
 - 9 **Hercules Wire Identification**
Including a Cross-Reference Chart
 - 12 **Steel Cylinders for the JetStar MLG Actuators**
You Can Install These Preferred Spares
- StarTips**
- 6 A Quick Way to Drain Hercules Aux Tanks
 - 11 How to Bleed a Hercules Hydraulic Pump – and Keep It Clean



HERCULES

Propeller Control

Oil Level Check...

USING THE ATMOSPHERIC SUMP DIPSTICK

Checking the Hercules propeller control oil level may appear, at first thought, to be a simple matter. However, improper checking continues to be the cause of many propeller problems.

To make oil level checking easier and more accurate, an atmospheric sump dipstick has been added to the pump housing assembly. The atmospheric sump dipstick is in addition to the original pressurized sump dipstick. It can be retrofitted by Hamilton Standard Commercial Service Bulletin HS Code 54H60 No. 39 or Military ECP. Most late model Hercules aircraft incorporated this improvement during production. Figure 1 shows this configuration.

3

It is possible that an aircraft may have both configured pump housings installed, especially if one or more of the originally delivered propellers has been replaced. That is, one prop with an atmospheric sump dipstick and the others without – or any such combination.

ATMOSPHERIC SUMP DIPSTICK

How does the atmospheric sump dipstick give an easier and more accurate oil level check? Let us look at the propeller control oil system briefly. There are two oil reservoirs – the pressurized sump and the atmospheric sump.

The PRESSURIZED SUMP is the reservoir for the main, standby, and auxiliary pumps; and is pressurized at 15 to 20 PSI to prevent cavitation of the pumps at altitude. Hydraulic pressure for the pitch changing mechanism is provided by the oil (under control of the valve housing assembly) supplied by these pumps. This oil, except for the portion used for lubrication and that involved in internal leakage, returns to the pressurized sump. The portion of oil that is utilized for lubrication or is involved in internal leakage drains into the atmospheric sump along with the excess fluid from the pressurized sump.

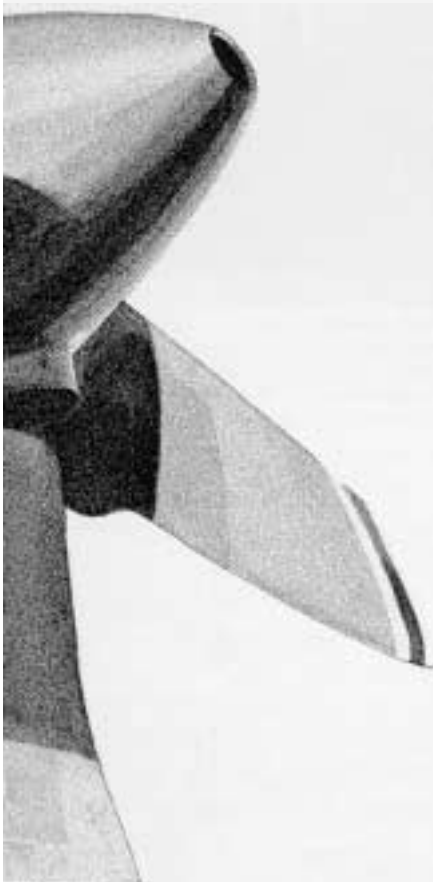

The ATMOSPHERIC SUMP is the reservoir for the main and auxiliary scavenge pumps. These pumps replenish the pressurized sump with oil under pressure to maintain the 15 to 20 PSI pressure in the pressurized sump. In order for the scavenge pumps to perform properly, the oil level in the atmospheric sump must stay within a certain range. If the oil level is too low, an inadequate oil level in the pressurized sump will result and the scavenge pumps will cavitate, thereby introducing air into the oil system. If the oil level is too high, the elevated oil level and normal pump action result in lip seal damage and subsequent lip seal leaks.

This range is reflected on the atmospheric sump dipstick's lower markings (refer to Figure 2), consisting of an upper mark, a legend - "OP LEVEL," and a lower mark. If the oil level is anywhere *between* these two lower marks, there is a sufficient quantity of oil. This feature provides flexibility in refilling, reduces the chances of overfilling; and, if the control is properly serviced, assures that the scavenge pumps are provided with the right amount of oil.

- 4 With the pressurized sump dipstick, one has to contend with adding small quantities of oil at more frequent intervals, and it cannot be determined how much reserve is in the atmospheric sump. Do not be concerned, though, if this is the version you have. Just follow the procedures contained in the applicable maintenance and servicing publications.

NOTE: *The following is used for information purposes only. Use your own approved procedures for actual servicing.*

SERVICING

First assure that the propeller control oil is warmed to its operating temperature - either by warm air or by running the engine; then cycle the propeller from ground start blade angle to feather and back to ground start blade angle. Now we come to the difference between the two checks.

PRESSURIZED SUMP DIPSTICK CHECK - Wait two minutes, carefully unlock the oil filler cover (or you might get a face full of oil), remove the dipstick and check the oil level. If indicated, add the required amount of oil, recycle the prop, and recheck the oil level.

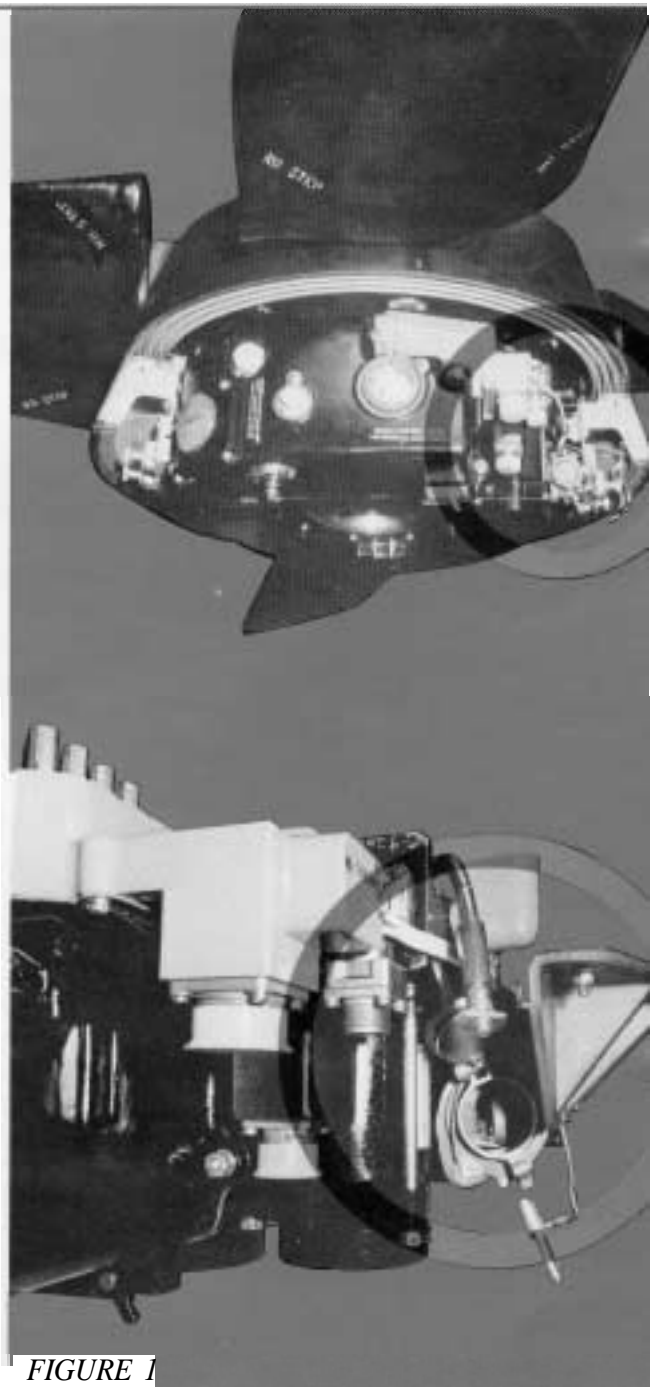

FIGURE 1

Top picture looks down on a propeller control unit that does not have the atmospheric sump dipstick. At bottom is a closer view of a recent unit showing dipstick handles for both atmospheric and pressurized sumps. The pushbutton for the flexible atmospheric sump dipstick appears just above the open port to the pressurized sump.

ATMOSPHERIC SUMP DIPSTICK CHECK - After cycling the prop, bring it back to GROUND IDLE (GROUND START for commercial) and remove the dipstick (see note) while the auxiliary pump motor is still running. Why? Because you want to check the atmospheric sump oil level under operating conditions, and this is what the auxiliary pump is simulating. Its associated scavenge pump is supplying the pressurized sump and generating a certain amount of agitation to the oil in the atmospheric sump. As we pointed

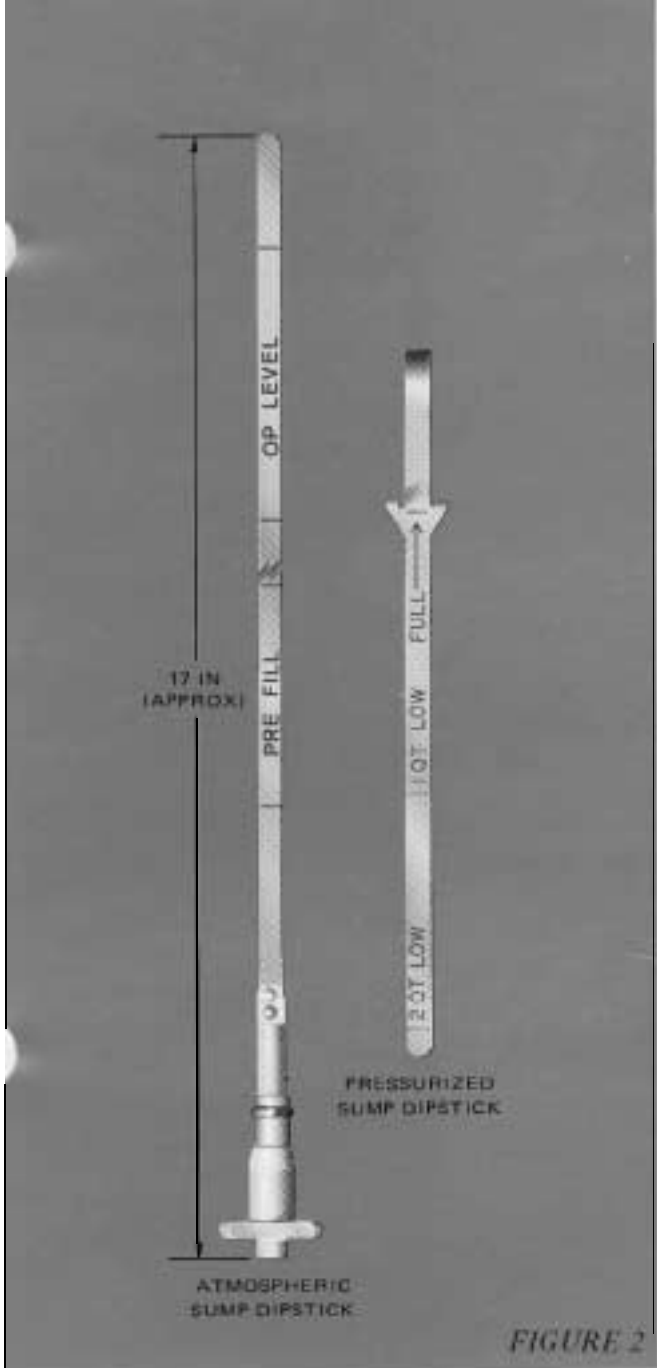

FIGURE 2

Be sure to run the engine, cycle the prop, and check the level again *before* draining oil.

OVERFILLING

Maintaining the proper oil level is very important. Low oil level can result in having to feather a prop and shut down an engine at a critical moment such as takeoff. Most propeller problems are less dramatic, but costly in time and money. A very common problem is overfilling. If there is too much oil, it will be forced out around the prop control lip seals. This will lead to lip seal damage and also show up as a propeller oil leak.

Now let us suppose that this leak is noticed on a preflight inspection by a crewman who is under pressure to get the airplane in the air. The gentleman in question, being in a hurry, wipes it up and checks the oil level. He then compounds his problem by not running the engine, or even cycling the prop. The pressurized sump has leaked down a bit, so he adds more oil – which ends up in the already overfilled atmospheric sump. (This would have been detected with an atmospheric sump dipstick). The aircraft takes off, and more oil is forced out around the prop control lip seal.

5

At one of the next inspections it is necessary to pull the leaking control and replace seals. Farfetched? Not at all. This has happened, or incidents similar to it, all too often. That is one of the reasons why the atmospheric sump dipstick has been added. Overfilling has been one of the major causes of unscheduled prop removal and overhaul.

NOMENCLATURE

We would like to clear up some confusion which might exist in terminology:

Feathering Pump and Auxiliary Pump – they are the same pump.

Oil Reservoir – it can be either the atmospheric sump or the pressurized sump, depending upon the one you are servicing,

DO'S AND DON'TS

DO become familiar with the procedures specified in your applicable maintenance/servicing publications, and follow them.

out before, if the oil level is anywhere between the two lower marks – this is satisfactory.

NOTE: *Take all oil level readings with dipstick locking balls seated on counter bore shoulder in tube. Do not depress ball plunger to allow dipstick to lock in place when taking readings.*

If the level is at, or near the lower mark, add oil as necessary. If it is above the upper mark, drain the oil until it falls within the two marks.

DO be sure the oil is at, or near, operating temperature before statically changing the blade angle, especially if the propeller has been exposed to temperatures of 0°C (32 F) or below.

DON'T overfill the propeller control. Drain if necessary.

DON'T run the auxiliary pump longer than its rated duty cycle. (You can run it longer providing you can hold your hand on it for 5 seconds or longer – approximately 150 F- *but monitor it closely.*)

DON'T let any precipitation or other foreign matter get into the oil filler ports.

DO run the engine before checking the oil, especially if the aircraft engine has not been run for two days or more.

DO make a thorough visual inspection of the propeller control.

DO use only the proper oil. MIL-H-5606B is preferred, but MIL-H-6083 can be used. The latter contains a preservative and tends to turn dark with use.

DON'T let oil spill on electrical contacts or de-icer slip rings; but if this happens, clean thoroughly to prevent future electrical problems.

DO check at regular intervals. Hamilton Standard's Operation and Maintenance Instruction Manual (P5059) for the Commercial Hercules -91 and -117 props recommends you check the oil level at a period not exceeding 60 flight hours, or weekly.

To conserve fuel, try to check the oil level on the last postflight inspection while the oil is still warm and the pressurized sump is still full. This will save starting up four engines and running them for 10 to 12 minutes each to warm up the oil the next morning.

In closing, just remember to follow the applicable procedures, maintain it properly, and the propeller should give many hours of trouble-free service.



StarTips

QUICK WAY TO DRAIN HERCULES AUX TANKS

by P. R. LaMons *Service Analyst*

If you work on Hercules' that have the new beefed-up center wing section, you may know it's hard to empty the auxiliary fuel tanks quickly if the pump happens to quit with the tanks full of fuel. Lockheed has developed a simple tool to drain the aux tanks four or five times faster than you could using a pogo stick (see drawing). To make it, get yourself a short piece of five-eighths-inch OD pipe with standard threads. Drill four three-sixteenth-inch holes in the threads one-quarter inch from the end. Clamp a hose on the other end. Now, remove the center core of the airplane's "jiffy" drain with a wide blade screwdriver, and the small pogo plunger will fall out.

Next, screw the five-eighths-inch pipe into the drain where the center core was removed until the pipe opens the jiffy drain valve. Be sure the hose is clamped shut while the pipe is being put in place because when fuel flow starts, it won't stop until the tanks are empty. Remove the drain adaptor and re-install the pogo plunger and jiffy drain center core.

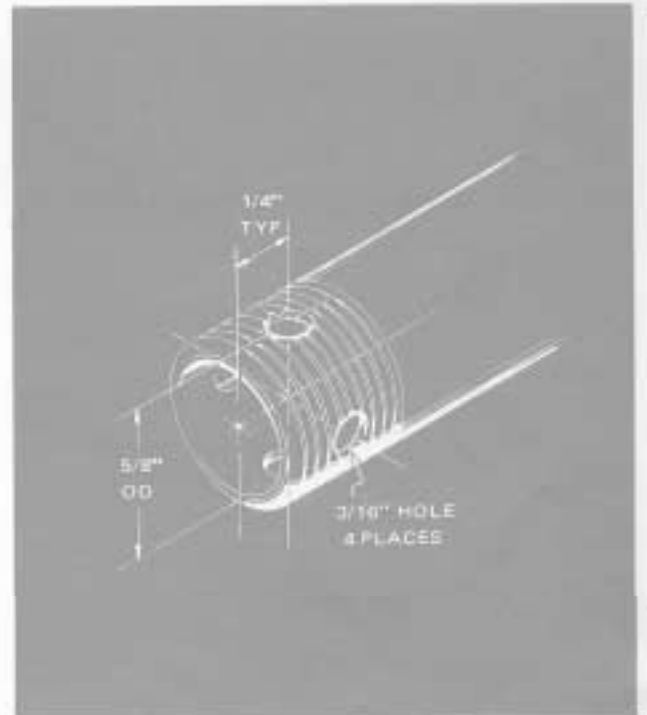

Reprint From AirLifters Vol. 4, No. 1

THE STANDARDIZED LOGISTICS MANAGEMENT SYSTEM

R. E. Aycock

Data Processing Systems Group Supervisor

V. W. Valentine

Management Systems Development Analyst

During the 22 years that the Lockheed-Georgia Company has manufactured aircraft and other high technology products, it has been necessary to develop a formidable capability in computing and data processing. This capability is now directly available to users of the Hercules.

In 1973 we developed the general specifications for a family of five data processing systems designed to assist C-130 operators in the control of spare parts inventory, procurement of spare parts, and maintenance of their Hercules. These systems are designed to support any type of airplane and can even be used to control and procure material not related to aircraft. All five systems perform the same basic functions but differ in complexity and processing techniques. This article describes the "middle" member of the family, Mark 3, which uses sequential files and can be implemented on a small or medium-scale digital computer or in one partition of a large, time sharing computer.

SLMS-MK 3 provides its user with an orderly approach to automating vital logistics management functions; it assists in keeping the user's fleet and major items of support equipment in a mission-ready condition; it helps to assure the availability of spare parts with the most economical ordering condition; it helps to assure the availability of spare parts with the most economical ordering intervals, thus minimizing capital investment; and it helps to assure flight safety and aircraft technical adequacy by managing specific maintenance tasks and requirements.

INVENTORY CONTROL SUBSYSTEM

The Inventory Control Subsystem is the heart of SLMS-MK 3. It:

Determines economic quantities of materials and spare parts to be procured and provides planned orders.

Determines and assists in maintaining optimum inventory levels of spare parts and materials, and assists in storing and locating them.

Shortens time spans required for procuring spare parts and materials.

Provides usage, shelf life, and other historical data for the manager and for the Procurement and Maintenance Subsystems.

Provides appropriate reports for management.

Provides the basis for financial control.

Utilizing factors input by the Logistics Manager, SLMS-MK 3 computes the economical order quantity. Each time disbursements are recorded, the balance on hand is checked and, if below a prescribed point, a potential reorder is evaluated. If the evaluation warrants, a request to procure is sent to the appropriate Logistics Manager for the necessary actions.

7



PROCUREMENT SUBSYSTEM

The SLMS Procurement Subsystem provides:

- Assistance in controlling financial commitments.
- Timely information on critical and long lead time items.
- Assistance in following up on delinquent purchase orders.

Purchase orders and amendments to purchase orders are the media used to procure spare parts and materiel. The requirement for the spare parts must be determined and proper authority obtained to begin the procurement cycle. In SLMS the initiation of the procurement cycle is made in the Inventory Control Subsystem. How much to order and when to order it are computed, and appropriate documentation is issued. The documentation is a preprinted request, which must then be validated by a Logistic Manager. When the need to procure has been formally translated and validated, the usual sources and contacts established by the user will be followed. SLMS does not interfere with the user's customary methods of dealing with vendors.

THE MAINTENANCE SUBSYSTEM

The SLMS Maintenance Subsystem provides:

- Means to preplan inspection workloads and reduce spares in pipeline.
- Inspection schedules and assurance of mandatory compliances.
- Reports on aircraft which require parts, kits, special tools for compliance.
- Historical data for performance, reliability, and trend analyses.

Effectiveness and economy in mission performance demand that maximum maintenance be performed at the lowest practical organizational level. The use of manpower, equipment, and facilities are normally based upon this principle. The SLMS-MK 3 has been designed to collect data in four areas which are important to the achievement of this goal: Component Repair Control; Modification Control; Time Change Control; Scheduled and Special Inspection Control. maintenance Control, Quality Control, and other dispatch of scheduling aspects of maintenance may be included within the SLMS-MK 3 Maintenance Subsystem after implementation, with the built-in flexibility provided initially.

COMPONENT REPAIR ACTION CONTROL – A large percentage of a maintenance organization's resources is used to repair aircraft systems, subsystems, and components. Management must have information feedback from these repairs.

In SLMS-MK 3 all maintenance jobs are recorded so that comprehensive data are available for analysis of failure rates versus equipment operating time; malfunctions related to inspection intervals; and reliability expectations for systems, subsystems, and components.

MODIFICATION CONTROL – Modifications are usually the result of changes or alterations to mission assignments, conditions for safety, and operational environments. It is essential that adequate records be maintained for each modification, so that the current status of each piece of equipment assigned to an organization is known at all times. SLMS-MK 3 will help maintain this status.

TIME CHANGE CONTROL – Certain parts or components installed on aircraft or other equipment must be occasionally removed for inspection or overhaul at the expiration of specified operating hours, landing gear cycles, days, or dates. These removals and related work, known as Time Changes, can generally be forecast in time to permit Inventory Control to review available assets and take action, if necessary, to meet the requirements.

SCHEDULED AND SPECIAL INSPECTION CONTROL – All equipment must receive repetitive inspections of sufficient thoroughness to verify serviceability or to detect deficiencies and malfunctions. Inspections are recurring, and compliance with the inspection requirements is normally mandatory. SLMS-MK 3 therefore maintains an accurate accounting of what inspections are required, when the inspections are due, when inspections have been accomplished, and an evaluation of whether equipment is being over-inspected.

IMPLEMENTATION

The Lockheed-Georgia Company believes that the capabilities of SLMS-MK 3 can play an important role in logistics management, and that its implementation by Hercules users can result in cost-effective logistics management. Implementation of SLMS-MK 3 is begun by a study, performed by representatives of the Lockheed-Georgia Company within the user's country at the locations where the system will be implemented, to adapt the general specifications to the user's specific requirements. This first phase lasts about 90 days.

After this study or adaptation phase, implementation is accomplished with the analytical and programming resources of the user, of the Lockheed-Georgia Company, or of both. Lockheed-Georgia is prepared to implement SLMS-MK 3 totally, but it may be more economical to take advantage of the user's resources. Implementation, which might take nine to twelve months, is accompanied by appropriate training and familiarization with input forms, procedures to be used, and the out put reports, all provided at the user locations by Lockheed-Georgia Company representatives.

For further information and a brochure describing SLMS-MK 3, contact:

E. W. Herron
Director of Information Processing
D/87-01, Zone 514
Lockheed-Georgia Company
Marietta, Georgia 30063

by JACK ATKINSON,
COMPONENTS ENGINEER SENIOR

Sometimes the job of replacing a damaged Hercules wire involves more than removing one part and installing another. In some cases a damaged wire to be replaced is identified on the wiring diagram by a Lockheed specification or a supplier number, and the technician cannot identify or associate this wire with a military specification, or standard, or an equivalent supplier number with which he is familiar.

Usually, he contacts the Lockheed Field Service Representative, who can provide the information for him. Several alternatives may be offered. When the advice is conveyed back to the technician he may find that wire for replacement is at his own facility.

Maybe this has happened to you. **So** let's review the most commonly used Hercules electrical wire and cable. On a following page is a table that shows equivalent and superseded callouts as well as adequate replacements.

Most of the wire listed in the table is standard airframe material; so, if the technician knows what the wire is, he can often make his own decision, in time of emergency, as to what substitute can be used. Let's look at some of the wire types.

PROPELLER HARNESS

The wire used in propeller harnesses in the engine nacelle is enclosed in stainless steel conduit and asbestos sleeving since these harnesses are expected to function for a short duration in case of an engine fire. The specification called out on most existing diagrams for the wire is MIL-W-7139. Newer design diagrams call out MIL-W-22759/1. Both of these specifications cover wire consisting of a silver coated copper conductor and TFE-Teflon primary insulation which may be taped or extruded. There is a layer of treated glass tape, or an additional TFE-Teflon tape. The outer covering is a TFE-Teflon coated glass braid. This wire is good for 200 C (392 F) continuous conductor temperature.

GENERAL PURPOSE WIRE

The most widely used wire on the Hercules is called out as LAC 1-140d by the majority of existing wiring diagrams. This wire is basically MIL-W-5086/2A which is being specified on new design wiring diagrams. It is a general purpose wire that is insulated with polyvinyl chloride (PVC) and glass braid. It has a nylon jacket which is extruded on sizes AWG 22 through AWG 12 and braided for larger sizes. The braided jacket is saturated with a nylon lacquer which seals the braid. This wire is used in areas throughout the airplane where the conductor temperature is not expected to go above 105 C (221 F).

The most widely used **shielded** wire or cable is called out as LAC 01-2049 which is basically MIL-C-7078/3 which is being specified on new design wiring diagrams. This cable consists of MIL-W-5086/1 as the basic wire shielded with tinned copper braid and covered with a nylon jacket.

FUEL QUANTITY WIRE AND CABLE

All wire and cable used inside the fuel tanks is Teflon-insulated. The hook-up wire is MS 18000, which has mineral-filled TFE-Teflon, and the cable is Lockheed specification LAC 01-2031, which is a TFE-Teflon insulated wire that is shielded and jacketed. The shield is a nickel-plated copper braid and the jacket is extruded FEP-Teflon. Outside the tanks, conventional hook-up wire is used. The cable outside the tanks is primarily LAC 01-203 1; however, in some installations Surprenant No. 4987 is called out. It is polyethylene-insulated and nylon-jacketed. The Teflon-insulated, fuel-resistant wire and cable may be used outside the tanks.

ENGINE WIRE

The standard wire for the engine area is MIL-W-8777, which has a silver-plated copper conductor and silicone rubber primary insulation. Over the primary insulation, there is a glass braid and then a Dacron braid which

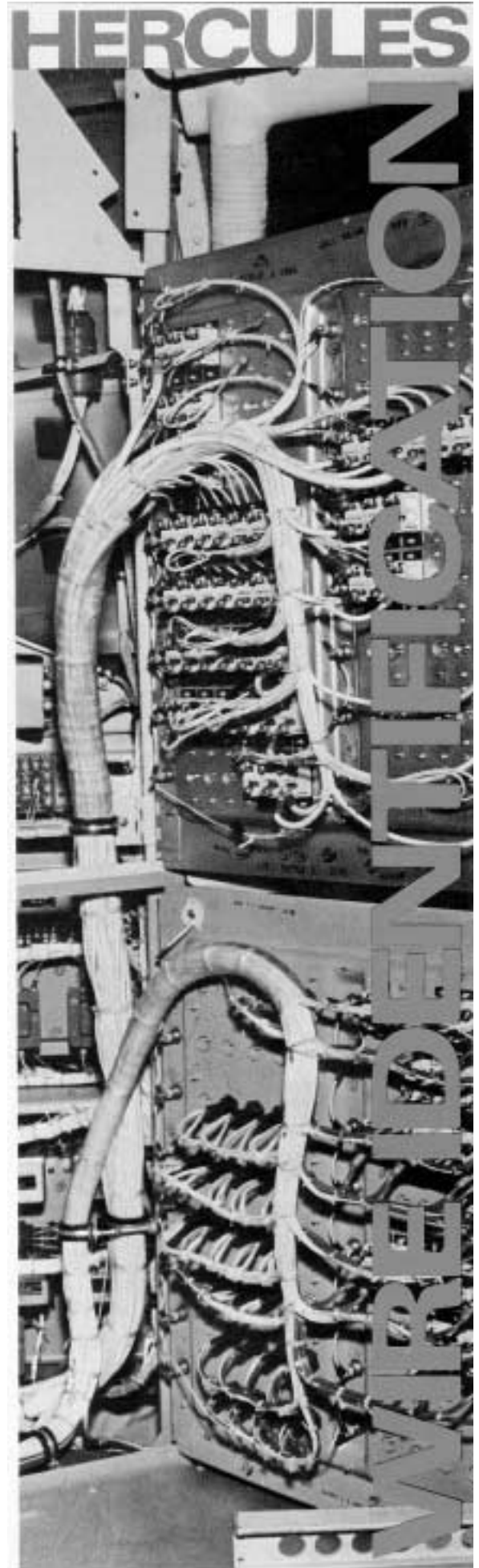







DRAWING CALLOUTS

APPLICATION

ADEQUATE REPLACEMENT

(Specification or vendor number)

MI L-W-22759/1  LAC 01-2032A or later  MIL-W-7139  Packard PE 400  warren ww 400. ww 500	Prop control harnesses	MIL-W-7139A MIL-W-7139B Class I MI L-W-22759/1 or /2
MIL-C-27500 (*) H (**)S5  LAC I-138 LAC -01.138	Shielded and jacketed engine area wire	LAC 01-137 MIL-C-27500(*)E(**)S4 or S5 (*)EA(* *)S4 or S5 (*)D(**)S4 or 5 (*)N(**)S5 (*)F(**)S4 or 5 (*)RB(**)S4 or 5
MIL-C-27500(*) RB (**) S5  LAC 1-137  LAC 01.137	Shielded and jacketed medium high temperature	MIL-C-27500(*)E(**)S5 (*)EA(**)S5 (*)D(**)S5 (*)N(**)S5
LAC 01-159  AF 32659  LAC I-110  LAC 01.110	Fire zone wire and cable	MIL-C-25038 MIL-W-25038 MS 27125
LAC 01-2033 Type I Type II	Fire zone wire and cable	For Type I Only Type II
MS 18000  ITT (Surprenant)SAKF728A  Minn.-Honeywell 6816-3  LAC 01-2035	Fuel quantity hook-up wire	LAC 01.159 MI L-C-25038 MI L-W-25038 MS 27125 MIL-C-27500 (*)JA(**)N7 MI L-W-22759/7 or /8
MI L-W-8777	Engine wire and medium high temperature applications	MIL-W-7139A MIL-W-7139B Class I MIL-W-8777 A or B MIL-W-22759/1, /2, /3 or /4 MS 2547 1 MS 27110 MS 90294
LAC 01-2031 Rev. G3  LAC 01-2031 Rev. G1 & G2  LAC 01-2031A  ITT (Surprenant) X-12109 CBB 59Y AAA 12258  Minn.-Honeywell 1272-2  Tensolite 1934 TX2801 SJ	Fuel quantity cable	Best to use only that which is called out or the superseded cable es shown.
Surprenant No. 4987 (ITT)	Fuel quantity cable – outside tanks only	LAC 01-2031 Rev. G 1, G2 or G3
MI L-W-5086/2 (M 5086/2)  LAC I-140  LAC 1-140a. b, c, d  LAC 1-166a  Rockbestos RSS 48A	General purpose interconnecting wire used throughout airplane	LAC 01-140 MIL-W-5086A Type I Of III MI L-W-7139A MIL-W-7139 B Class I MIL-W-8777 A or B MI L-W-22759/1, /2, /3 or /4 MI L-W-81044/2,6 or /9 MS 25190 Type A or 8 MS 25471 MS 27110 MS 90294
MI L-C-7078/3 (M 7078/3)  LAC 01-2049  LAC 01-136  LAC 01-135  LAC 1-135a, or b	General purpose shielded wire used throughout airplane	LAC 01-137 LAC 01-138 MS 25192 MIL-W-7078A Type II MIL-C-27500(*)A(**)T2 (*)D(**)S5 (*)H(**)S4 or 5 (*)F(**)S4 or 5 (*)N(**)S5 (*)MA(**)SS,T8, 513, orT13 (*)ME(**)S8,T8,S13, orT13 (*)MH(**)SB.T8,S13. orT13

NOTES:

The applications shown above are for general identification only and by no means are complete. All materials listed under "adequate replacement" are considered functional equivalents or better. Cost, weight, size and appearance may vary for these materials when compared with original callouts.

*AWG Number

**Number of wires

 Indicates superseded Lockheed procurement callouts that remain on many existing drawings.

are saturated with a lacquer. The wire is good for conductor temperatures up to 200 C (392 F). This same wire is also used with a silver-plated copper-braided shield and a jacket of braided Dacron saturated with lacquer. The shielded version is identified as LAC 01-138 on most existing diagrams and MIL-C-27500 ()H()S4 on new design drawings. Wire to MIL-W-8777 and MIL-C-27500 ()H()S4 are also used in other areas of the airplane for isolated applications.

FIRE ZONE

The wire used in fire zone applications is identified as LAC 01-2033 or LAC 01-159 and consists of nickel-clad copper conductor insulated with asbestos, glass tape and outer glass braid with a TFE-Teflon resin finish. This wire is basically MIL-W-25038; however, Lockheed specifications require an extended flame test. Therefore, the wire exceeds the military

requirement. Fire zone wire is good for continuous operation at temperatures of 342 C (650 F) and for 5- to 15-minute duration in a 1093 C (2000 F) flame. In many applications where the normal temperature never exceeds 149 C (300°F), nylon-jacketed LAC 01-2033 Type I wire is used.

In case of fire, the nylon jacket will burn off, leaving the basic wire intact since the nylon jacket was added for mechanical protection only. Quite often the nylon jacket of LAC-01-2033 is damaged, but this does not alter the functional capability of the wire. Therefore, it is not mandatory to replace the wire unless the insulation of the basic wire is damaged. For applications where the normal temperature exceeds 149 C (300 F), LAC 01-159 is used.



StarTips

HOW TO BLEED A HERCULES HYDRAULIC PUMP- AND KEEP IT CLEAN

by FRED HEHMEYER Service Representative

You don't have to put up with hydraulic fluid all over when you bleed Hercules engine-driven hydraulic pumps at the nacelle bleed fitting. Go this cleaner route instead:

Fill and check the fluid level in the reservoir, then with a-c ground power plugged in, turn the utility and booster system suction boost pumps "on." Assuming you're bleeding the number one engine pump, first switch the *number two* pump "off." (If it's number four, turn off number three, and so on.)

Now cycle the aileron controls 25 times. Fluid moving through the system will automatically expel air from the line as it comes back around to the reservoir. Top off the reservoir, reset all switches back to "normal," and you're clean for the next flight.

Reprint From: AirLifters Vol. 3, No. 1

Steel Cylinders

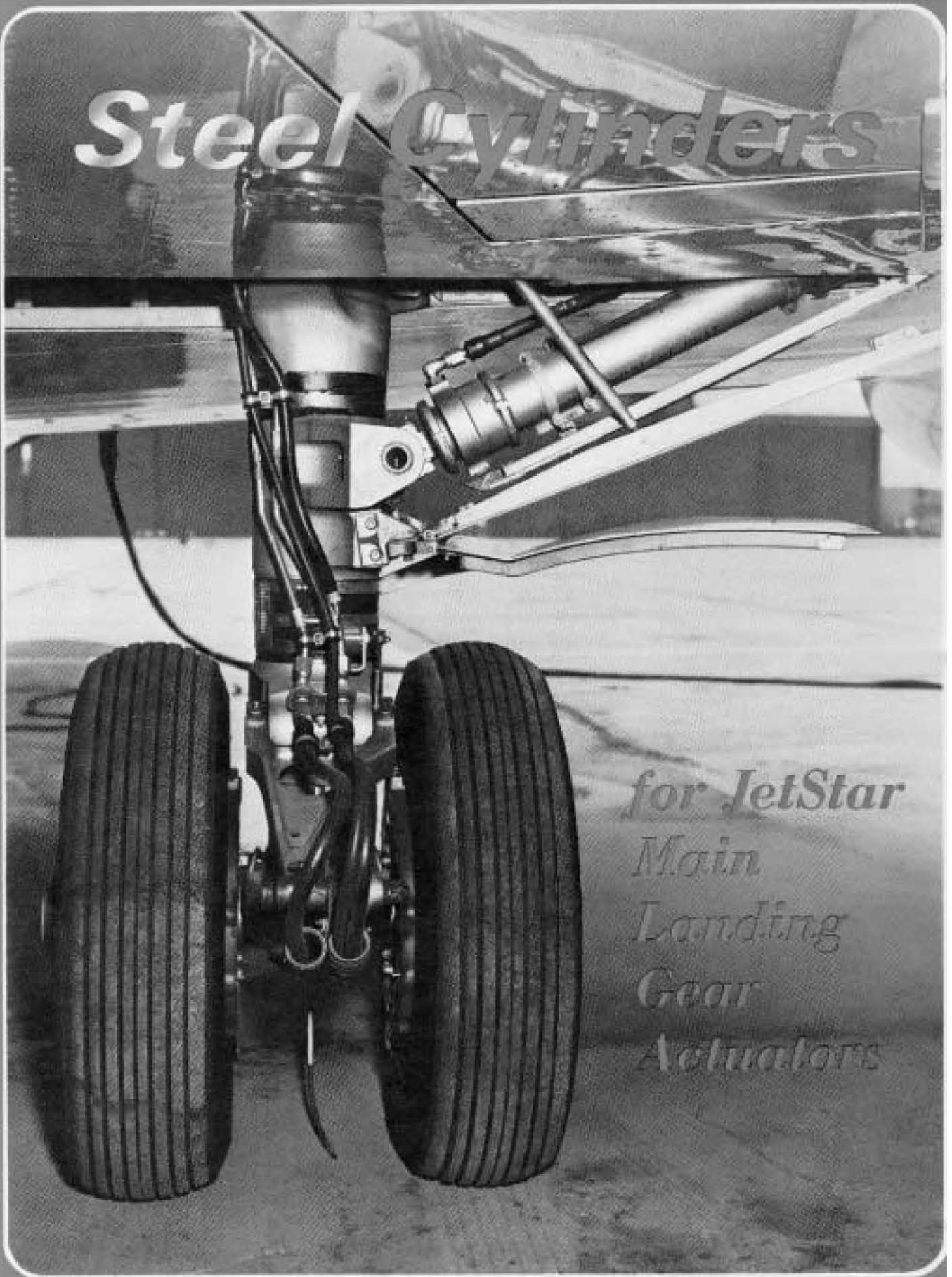

*for JetStar
Main
Landing
Gear
Actuators*

WHICH IS BETTER, aluminum or steel, for an airplane part? The answer to that is not always obvious. Both are used. Aluminum is lighter. Steel is stronger. There are many other characteristic advantages in each of these metal alloys. In some applications, the trade-offs make the choices about equal. In some cases, a better choice is apparent only after several years of operations.

We now know that steel is preferable material for the cylinder, or “barrel”, in the actuating cylinder side brace assemblies that retract the main landing gear on the JetStar. If you have not already done so, we recommend that you update your actuating cylinders with this preferred spare as soon as practical.

At overhaul, the aluminum cylinders are being replaced by steel at the customer’s option. Many JetStar Owners are updating their own earlier by ordering the cylinders and repack kits from Lockheed and replacing the aluminum cylinders at their maintenance facilities. This replacement does not postpone overhaul. If less than 10% of the time between overhaul remains on your landing gear actuators, you may want to send them on to an authorized overhaul facility for the complete job.

If you buy the actuators assembled, and they have been in storage, you may want to be certain that all seals and packings are functioning properly, and that the downlock switch is correctly adjusted. Refer to the functional and switch test instructions given later in this article.

TO UPDATE both of your main landing gear actuating cylinders you need two new steel cylinder barrels (part number each P/N JL 140 1-2) and two repack kits (part number each P/N JSK604-2). These parts are the same for right or left assemblies. The drain holes in existing end caps make them different for right and left assemblies. Other right and left parts are the switch adapters and locking arms.

Repacking this actuator is about the same as for any comparable hydraulic unit of a system using fluid to specification MIL-H-5606 operating at 3,000 PSIG. All of the preformed packings and seals have standard part numbers. There is a new preferred part for the shaft seal, identified on the blueprint as P/N 222 FT-160A-T.

This “T” shaped preformed rubber ring is installed with two teflon backup rings, one in each recess of the seal. The stem of the seal is in contact with the shaft. This arrangement has great resistance to destructive deformation of the rubber imposed by the hydraulic pressure and the shaft movement.

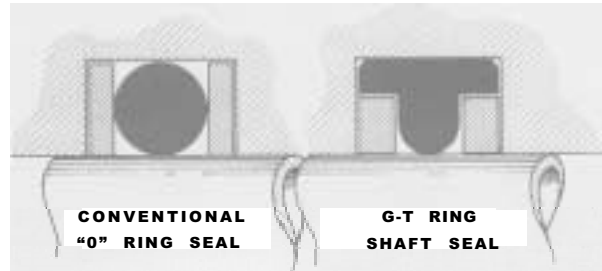

A hydraulic test stand capable of up to 4,500 PSIG is necessary for functional testing of the reassembled cylinders and the downlock switch. A minimum of 1,500 PSIG is necessary to operate the cylinder while adjusting the downlock switch. This adjustment is the last in the series before the actuator is installed. A suitable meter or light to indicate electrical continuity is necessary to check the switch adjustment.

13

REFERENCES

The JetStar Handbook of Operating and Maintenance Instruction (HOMI) and T.O. IC-140A-2-4 have, in their landing gear sections, the dimensions and instructions in the order of their adjustment. In addition, you should have our blueprint that gives complete assembly instructions, as well as part numbers and dimensions. Ask for blueprint number JL1470, ACT. ASSY – MLG SIDE BRACE and send your request to:

Lockheed-Georgia Company
JetStar Support
Dept. 64-22, Zone 287
Marietta, Georgia 30063

Attn: Mr. J. R. Weiland

WE WANT TO EMPHASIZE THE IMPORTANCE
OF SEVERAL REQUIREMENTS
IN ADJUSTMENTS.

DOWNLOCK OPERATION

The landing gear downlock is inside the actuating cylinder end cap. The importance of its function

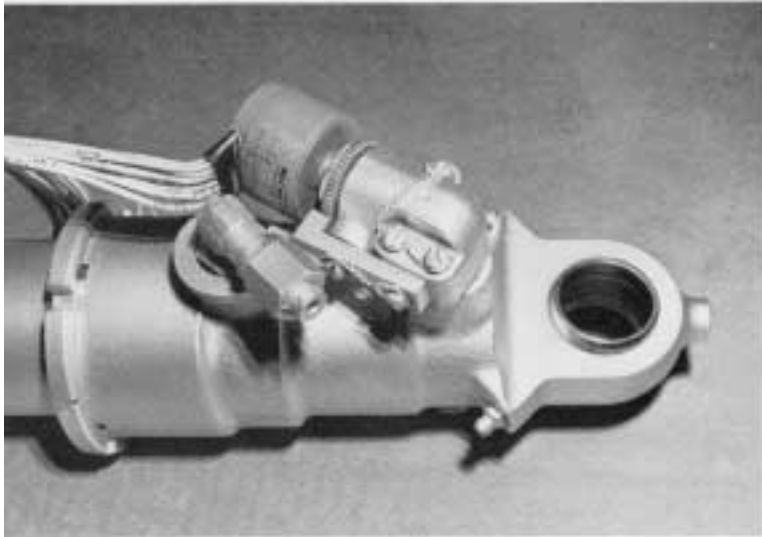
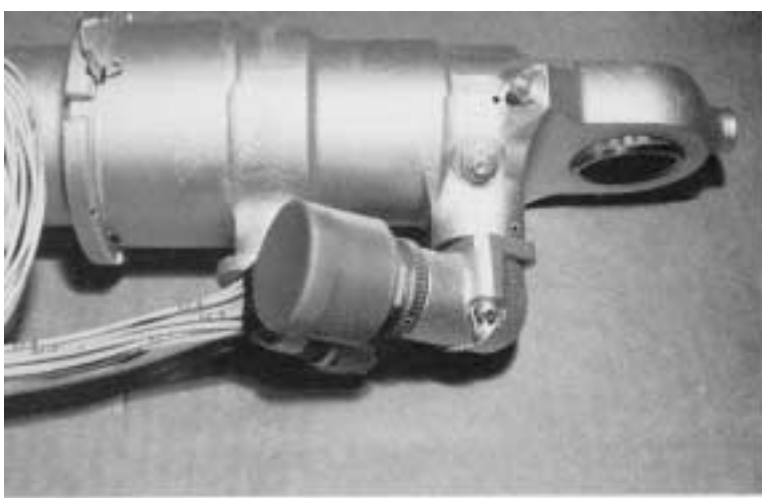

End cap of a main landing gear actuator for the left side. Top view is bottom up to show drain hole near grease fitting. Bottom view shows secured downlock switch and elbow connector for the hydraulic landing gear up line. The clearance shown is minimum for installing the tubing nut.

suggests careful attention to details in reassembling this unit. In actual operation, the lock mechanically engages when the landing gear is fully extended. To retract the landing gear, hydraulic pressure releases the lock when the selector valve is placed in the "UP" position. The movement of a circular piston, resembling a sleeve, does the job. A spring loaded latch holds the sleeve in the unlocked position.

Note 13 on the blueprint is important to the function of the landing gear downlock mechanism. The 1.421 inch dimension is critical to timing the release of the spring loaded locking sleeve or slide. This sleeve moves inside multi-finger tangs projecting from the piston head, after their enlarged ends snap through a circular retaining shoulder inside the end cap. This dimension is to be the final measurement from the tips of the fingers to the adjustable plug in the piston rod which triggers the release of the locking sleeve or slide.

The downlock light switch is operated through rods moved mechanically by a ridge encircling the outer end of the locking sleeve. Later, a functional test of both the downlock and the switch is made to check their adjustments. The success of this test depends on your accuracy from the beginning. Avoid remaking early adjustments that were just a little beyond limits. For instance, remember to maintain equal thread engagement on both ends of the cylinder in setting the 0.412 inch dimension at the shaft end of the actuator.

Anticipate the clearance you will need when positioning the hydraulic elbow fitting near the switch in the end cap, because you will not have access to the lock nut on the elbow after the switch locking arm is in place. And remember, also, that the switch cannot be adjusted after the cylinder is installed on the landing gear.

Follow carefully the instructions for positioning the switch terminals, and try the locking arm in place to verify its position relative to the elbow and switch adapter, before you start final adjustments of the switch.

Check the push rod P/N JL1443-1 in the adapter housing assembly for freedom of movement. Some of these rods have been found to fit too tight. The hole in the plug P/N JL 144 1-1 should be reamed to a slightly larger size in these cases.

Remember that the drain hole for the cavity under the switch is to be down when the actuator is installed. This means, also, that the right and left assemblies will have the switch and hydraulic fittings at different angles.

LEAK TEST

After the actuator is assembled and ready for hydraulic leak tests, connect the two cylinder ports to the working ports of the test stand. Cycle the unit at least three times, making sure all air is bled from the system. The centerline dimensions given on the blueprint for extended and retracted shaft positions should be checked at the operating pressure of 3,000 PSIG by applying pressure alternately to each port.

Reduce pressure, then slowly apply 4,500 PSIG to one side of the piston for two minutes. There should be no evidence of distortion or external leakage. Then perform the same test with pressure applied to the other port. Internal

leakage is checked at the same proof pressure of 4,500 PSIG on each side of the piston with the opposite port open. Internal leakage, measured by catching fluid from the open port, is not to exceed 5 cc per minute.

Connect the working lines again, adjust the pressure to 3,000 PSIG, and cycle the cylinder twenty-five times to check the shaft seal. External leakage here is not to exceed one drop in twenty-five cycles.

The working hydraulic connections should remain connected for adjusting the downlock switch. A minimum of 1,500 PSIG is required.

SWITCH ADJUSTMENT

The downlock light switch case is about one and one half inches in diameter with a threaded stem that screws into a bushing that adapts it to the adapter housing. The housing encloses two push rods at a 90° angle with a triangular rocker between them. The housing is fastened with screws and sealed with an O-ring against a drilled projection on the end cap. The inner rod is actuated by the ridge on the internal locking sleeve as mentioned previously. Check the rods again for freedom of movement in the adapter as the sleeve moves.

Turning the adapter bushing adjusts the depth of the switch in the housing, which, in turn, positions the electric contacts in the switch to indicate the position of the landing gear downlock sleeve.

With the hex jam nut threaded free on the switch stem, adjust the serrated adapter bushing to clear the rocker housing a little more than 1/16 inch

with the switch base 5/8 inch clear of the housing. Rotate the switch to position the wire terminals at 70° ±5° from the axis of the shaft as shown on the blueprint.

The switch must be held in this position until adjustments for electrical continuity is complete. Connect the switch lead number one to your electrical continuity checker and locate leads number two and three for reference. The working hydraulic lines should be connected. The piston should be in the retracted and locked position.

Rotate the bushing until leads one and three are electrically continuous. Mark or select a reference point on the adapter housing. Then hydraulically unlock and extend the piston shaft. Readjust the adapter until leads one and three are again electrically continuous, counting the serrations, or teeth, past a reference point. Finally, back off one half the number of teeth difference in the previous adjustment. Now check lead number two for continuity with number one, with the piston still in the unlocked position. Leads number one and three should be electrically open until the piston is retracted and locked in what will be the landing gear down position on the JetStar.

These suggestions on updating your main landing gear actuators are by no means complete, and they are not intended to replace your authorized sources of instructions. We assume that you will have, for reference, blueprint JL1470 referred to earlier. We hope that the emphasis we have placed on various important and unique features will be helpful.

15

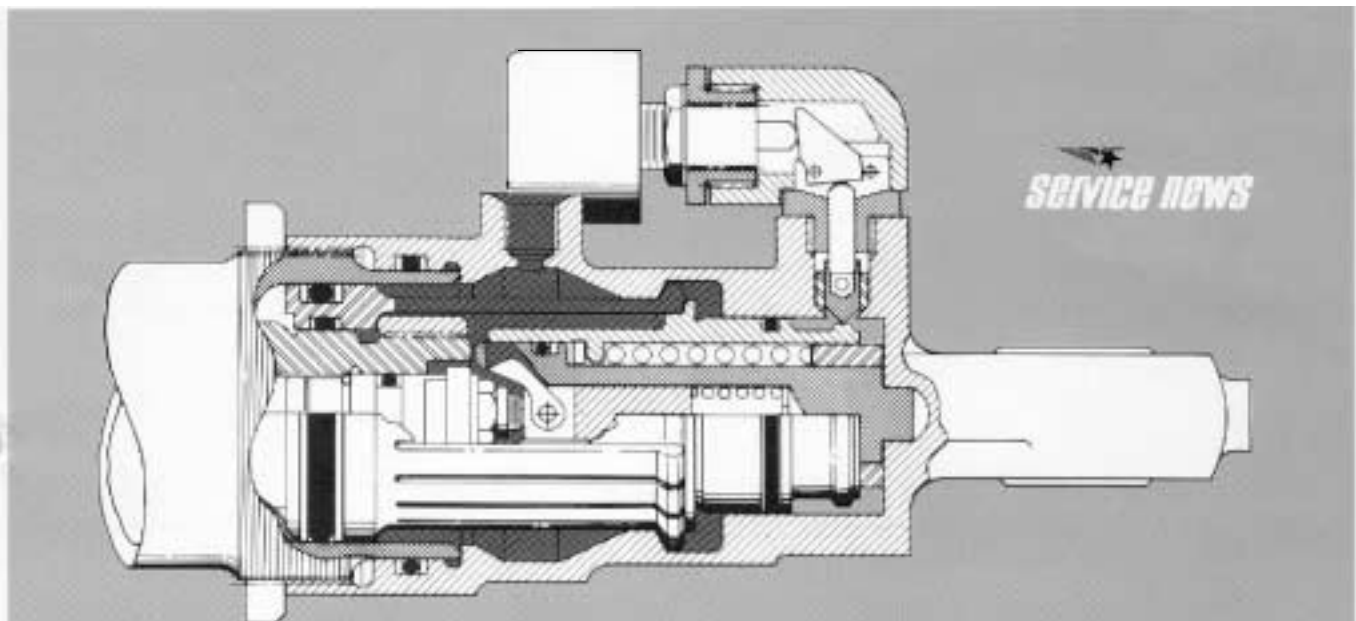

CUSTOMER SERVICE DIVISION
LOCKHEED-GEORGIA COMPANY
A DIVISION OF LOCKHEED AIRCRAFT CORPORATION
MARIETTA, GEORGIA, 30063

