

 Lockheed

# SERVICE NEWS

VOL. 10, NO. 2, APRIL—JUNE 1983



*Engine-Driven Hydraulic Pumps*

A SERVICE PUBLICATION OF LOCKHEED-GEORGIA COMPANY, A DIVISION OF LOCKHEED CORPORATION



A SERVICE PUBLICATION OF  
LOCKHEED-GEORGIA COMPANY  
A DIVISION OF  
LOCKHEED CORPORATION

*Editor*

Charles I. Gale

*Associate Editors*

Daniel E. Jolley

James A. Loftin

Steve Palmer

*Art Director & Production*

Bill Campbell

Vol. 10, No. 2, April-June 1983

**CONTENTS**

- 2 **Focal Point**  
M. J. Walters  
Staff Engineer
- 3 **Engine-Driven Hydraulic Pumps: A Brief History**
- 9 **Aft Cargo Door Actuator Modification**
- 10 **Life Raft Vent Valve Positioning**
- 12 **Upper Bumper Stop Repair Procedure**  
Jammed ring spring assemblies can be restored to service.
- 15 **StarTip**  
Protecting UHF and VHF Blade Antennas

Cover: The Republic of Indonesia is made up of over 13,000 islands and its need for efficient maritime patrol capability is clear. Our covers show the nation's first maritime patrol Hercules aircraft, a C-130H-MP.

Published by Lockheed-Georgia Company, a Division of Lockheed Corporation. Information contained in this issue is considered by Lockheed-Georgia Company to be accurate and authoritative; it should not be assumed, however, that this material has received approval from any governmental agency or military service unless it is specifically noted. This publication is for planning and information purposes only, and it is not to be construed as authority for making changes on aircraft or equipment, or as superseding any established operational or maintenance procedures or policies. The following marks are registered and owned by Lockheed Corporation: Lockheed, Hercules, and JetStar. Written permission must be obtained from Lockheed-Georgia Company before republishing any material in this periodical. Address all communications to Editor, Service News, Department 64-22, Zone 278, Lockheed-Georgia Company, Marietta, Georgia, 30063. Copyright 1983 Lockheed Corporation.

**Focal Point**

FINE-TUNING FOR SUCCESS

The hydraulic system of the Hercules aircraft first achieved operational status in its present form in the C-1306, and we have been "fine-tuning" it ever since. That fine tuning has resulted in a hydraulic system that compares favorably with the most recent designs in the industry, no matter which performance parameter is examined. There is solid evidence to support this claim. It is confirmed repeatedly in the reports we receive from those among our customers who operate other state-of-the-art airplanes in addition to the Hercules airlifter.



M. J. WALTERS

The performance record of the Hercules aircraft hydraulic system comes as no surprise to those of use who work with it every day. The basic formula for this success could hardly be more straightforward: start with a well-designed system, monitor every aspect of its operation over months and years, and improve or update it as required to ensure that its performance will remain second to none.

Most successful formulas seem to contain a secret ingredient that adds something special. Ours is the way those updates and improvements are carried out. Before any changes are made in this hydraulic system, we make sure that the result will be a better system and a substantive advantage for the operator. That is what fine-tuning is all about.

Let's look at a few examples. The kind of engine-driven hydraulic pumps installed as standard equipment in new-production Hercules aircraft has been changed several times over the years as better designs have become available. Those we use now incorporate many engineering advances, and include even a thermal off-stroke feature to protect against overheating. The lead article in this issue of *Service News* gives additional details about the improvements that have taken place in this area.

Another interesting example has to do with the electrically powered suction boost pumps that are used to ensure positive inlet pressure at the main engine-driven pumps. The boost pumps we install today were developed specifically for the Hercules aircraft. Hydraulic fluid circulates freely past the motor windings to the bearings in these pumps, yielding a four-fold increase in pump life compared to conventional pumps used in the same application.

Clean fluid is of paramount importance in every hydraulic system. In the Hercules aircraft, the main return and case drain lines are now equipped with filter elements that will remove particles three and five microns in size respectively. The result is hydraulic fluid as free of particulate contaminants as that in any airplane flying today – and longer trouble-free service for every component in the system.

There is of course much more. Improvements that have been incorporated in the Hercules aircraft hydraulic system include everything from a special shuttle valve to ensure reliable emergency nose landing gear extension to brake fuses that limit the amount of fluid lost in the event of hose failure.

We are proud of our hydraulic system. It has operated flare launchers, air compressors, aerial refueling systems, retractable skis, winches that pull survivors of sea disasters to safety, and all sorts of other things that were never envisioned when the system was designed. It is a practical, proven system that has demonstrated its reliability and adaptability many times over in the past, and will continue to do so in the future. After all, we are still tuning.

Sincerely,

*John Walters*  
M. J. Walters, Staff Engineer

**PRODUCT SUPPORT**

LOCKHEED-GEORGIA COMPANY  
MARIETTA, GEORGIA 30063

T.J. Cleland

Director

CUSTOMER SERVICE

INTEGRATED LOGISTICS SUPPORT

CUSTOMER SUPPLY

A. H McCrum  
DIRECTOR

J L THURMOND  
DIRECTOR

M M. HODNETT  
DIRECTOR

# Engine-Driven Hydraulic Pumps:

## ABRIEFHISTORY

by M.J. Walters, Staff Engineer

There is a strong family resemblance between the Hercules aircraft that were built a quarter of a century ago and those that are coming off the assembly line today. The explanation is simple: many of the advanced features incorporated in the basic design of the world's most versatile airlifter have not been all that easy to improve upon.

But appearances seldom tell the whole story, and this is especially true in the case of the Hercules aircraft. Despite superficial similarities between the old and the new, almost everything about this remarkable airplane has undergone carefully considered evolutionary change over the years. The extraordinary

adaptability of its major operating systems has long been one of the Hercules aircraft's unique strengths.

In this article we would like to look at one particular area of one system in some detail, the engine-driven hydraulic pumps. We will want to examine the changes that have evolved, and make note of the effect these improvements can have on such maintenance-related considerations as configuration control and interchangeability.

### System Evolution

The C-130B came off the production line equipped

Figure 1. Baseline hydraulic configuration on Hercules aircraft LAC 3501 to LAC 4181.

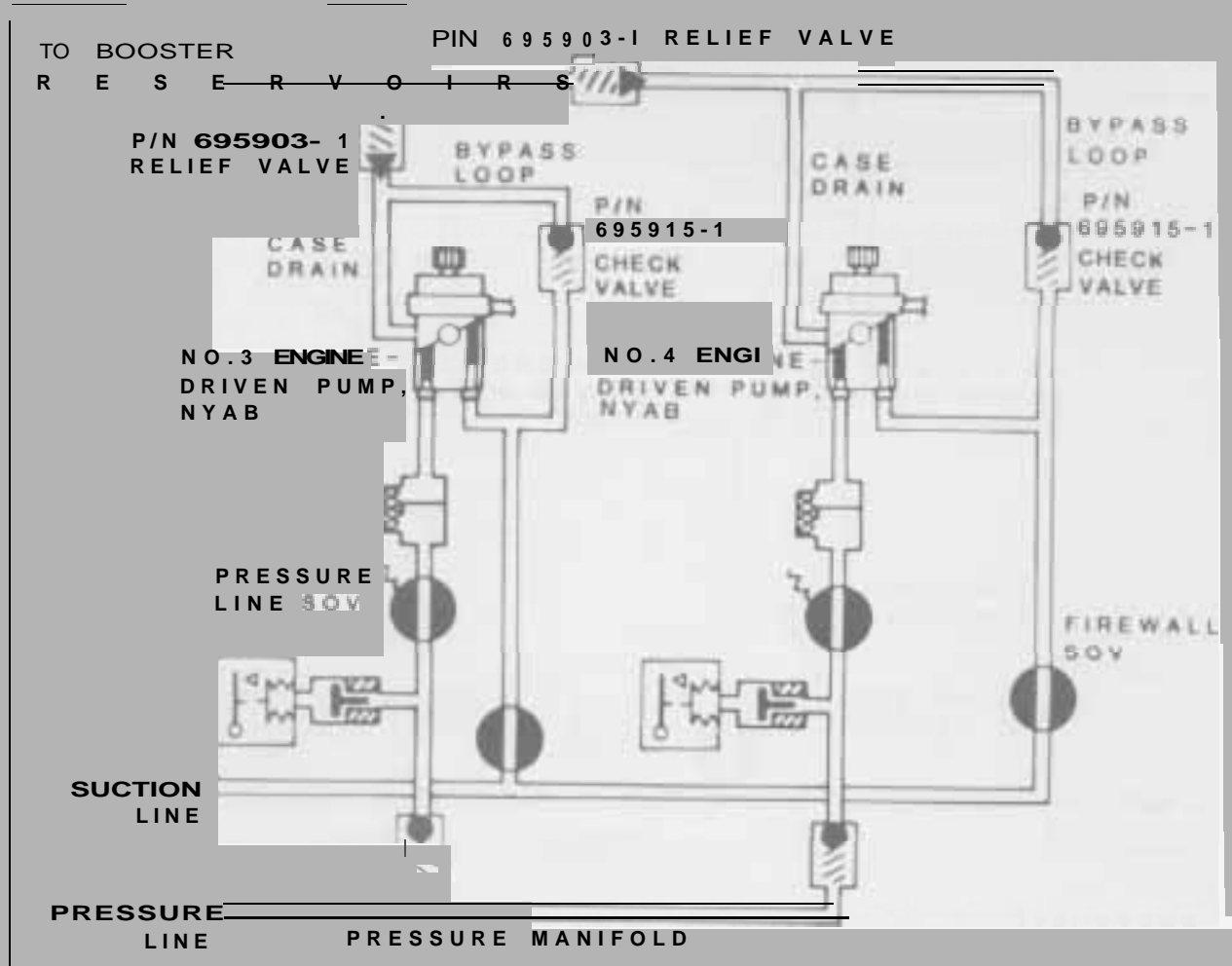

with P/N 66WBD300 New York Air Brake Company engine-driven hydraulic pumps. The New York Air Brake (NYAB) pump requires a bypass loop connecting the case drain line and the suction line (Figure 1). The bypass loop is required because the design of the pump is such that it receives its lubrication from the hydraulic fluid in the suction line. This causes no difficulty unless one of the engine-driven pump switches on the copilot's instrument panel is placed to OFF or the fire emergency handle for an engine is pulled. When this happens, the normal source of lubricating fluid for the affected pump is no longer available even though the need for lubrication is still present.

Here is why. Placing one of the engine-driven pump switches in the OFF position or pulling the fire emergency handle closes both the firewall and pressure line shutoff valves for that engine. But the pump continues to operate whenever the engine is running, and it must therefore continue to be lubricated. Without an alternative means of receiving lubrication, the pump would heat up and fail in a very short period of time.

To avoid such a possibility, a bypass loop for each

pump was incorporated in the system's plumbing for the specific purpose of maintaining lubrication to the pump when the firewall and pressure line shutoff valves are closed. The bypass loop routes case drain fluid back into the suction line and thereby provides the necessary lubrication. A P/N 695903-1 relief valve in the case drain line set to open at 22 psi ensures that hydraulic fluid will be forced into the bypass loop whenever loss of pressure in the suction line caused by the closing of the firewall shutoff valve allows the P/N 695915-1 check valve to open.

This plumbing configuration is the only one of those found on Hercules aircraft that will keep the NYAB engine-driven hydraulic pump lubricated and within its temperature design limit when it is operating and the firewall and pressure line shutoff valves are closed.

There was one minor change to the NYAB plumbing at Lockheed serial number LAC 4182. The 695903-1 relief valve was replaced by an improved relief valve, P/N 695903-3 (Figure 2). The change in relief valves did not affect the pump itself.

Figure 2. The baseline configuration of LAC 4182 to LAC 4429; note relief valve change.

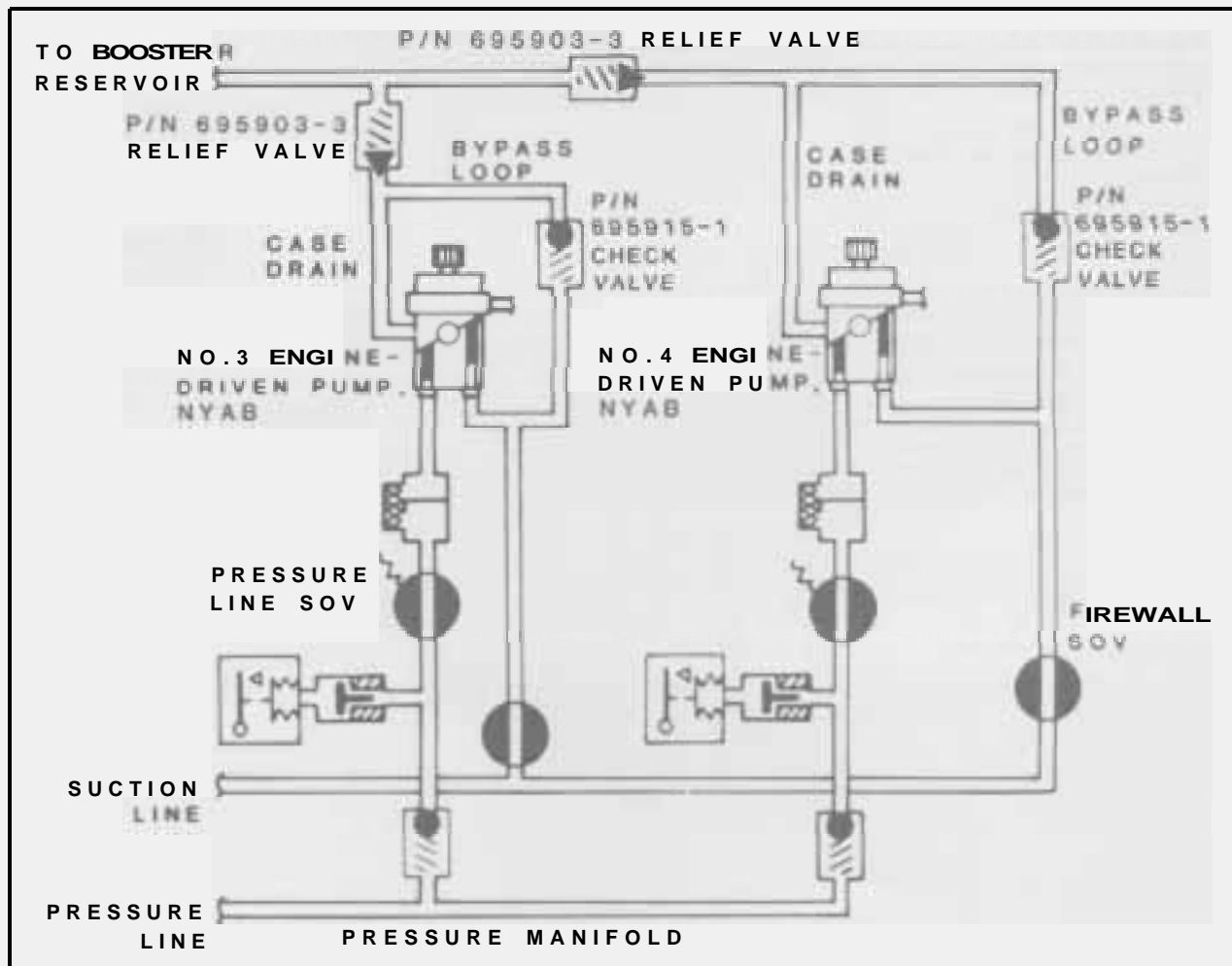

No other pump or plumbing configurations were available on new Hercules aircraft until Lockheed serial number LAC 4430. Starting with this aircraft, the NYAB pump was superseded on new production aircraft by a pump built by Vickers, Incorporated. This change was applicable to all new baseline Hercules aircraft except those built for the U.S. Air Force. On U.S. Air Force C-130s built subsequent to LAC 4430, Lockheed installed either NYAB pumps or Vickers pumps, depending upon which the Air Force supplied for installation at the time a particular aircraft was produced.

The P/N PV3-075-4 Vickers engine-driven hydraulic pump is an in-line pump whose design is such that it uses the fluid that has been forced into the case drain line for internal lubrication. Tests showed that with the firewall and pressure line shutoff valves closed, the use of a bypass loop caused the Vickers pump to generate an operating temperature that exceeded the permissible value. The bypass loop was therefore deleted from the plumbing configuration (Figure 3). The new arrangement allowed the Vickers pump to remain within safe temperature limits under all operating conditions.

Note that the 695903-3 relief valve remained in the case drain line in this configuration. Tests performed at Lockheed later determined that a check valve could be installed in place of the 695903-3 relief valve, and that a cost saving would result. The relief valve was therefore deleted, and a P/N 1112-589978 check valve used in its place starting with Lockheed serial number LAC 4459 (Figure 4).

With the change made at LAC 4459, there were a total of four distinct hydraulic plumbing configurations that a Hercules aircraft operator could have: NYAB pump, bypass loop, and 695903-1 relief valve (Figure 1); NYAB pump, bypass loop, and 695903-3 relief valve (Figure 2); Vickers pump, no bypass loop, and 695903-3 relief valve (Figure 3); or Vickers pump, no bypass loop, and 1112-589978 check valve (Figure 4).

### Abex Pumps Introduced

At Lockheed serial number LAC 4653, engine-driven hydraulic pumps manufactured by Abex Corporation became the standard pumps installed on baseline aircraft in place of the PV3-075-4 Vickers

Figure 3. At LAC 4430, Vickers pumps were introduced and the bypass loops deleted.

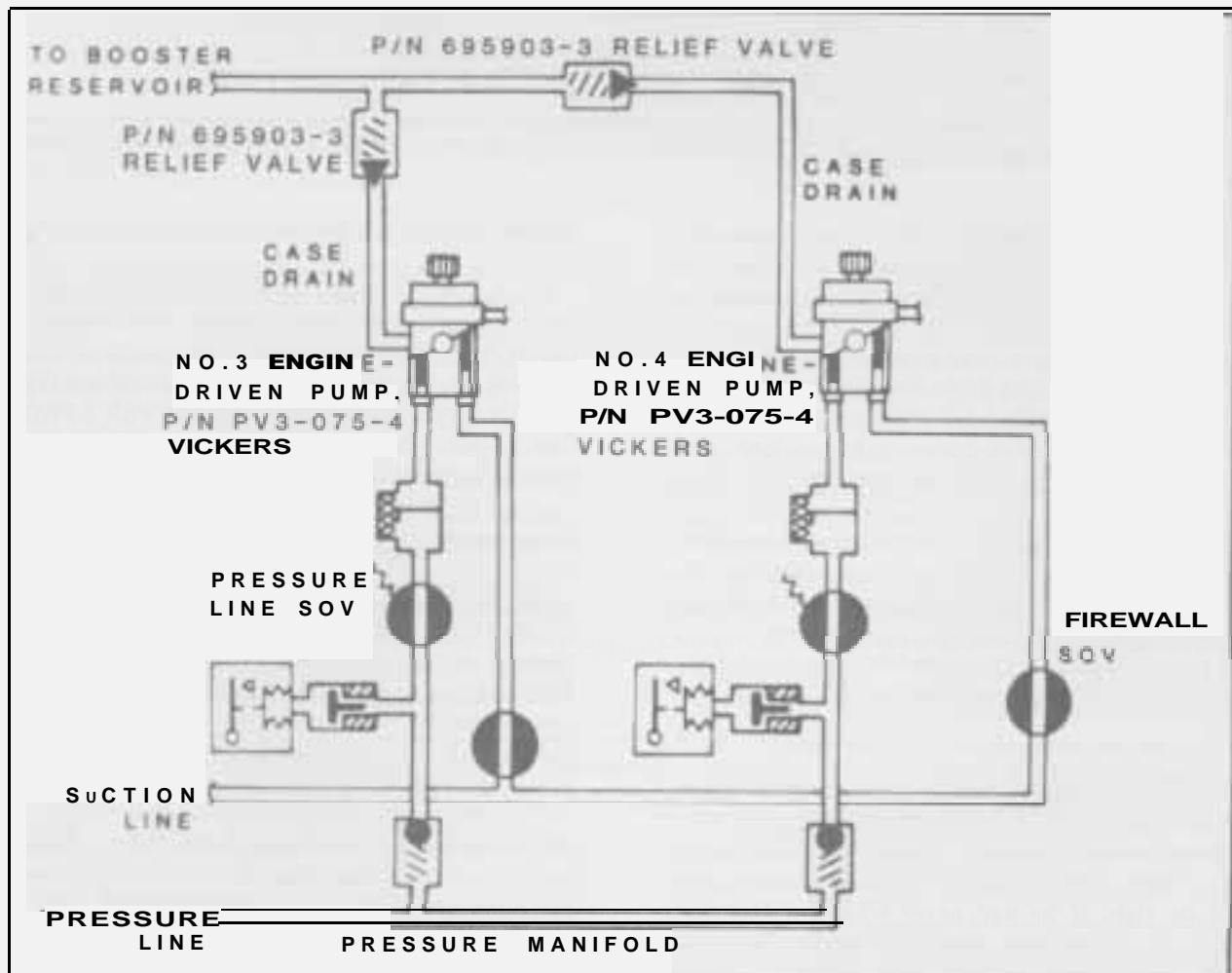

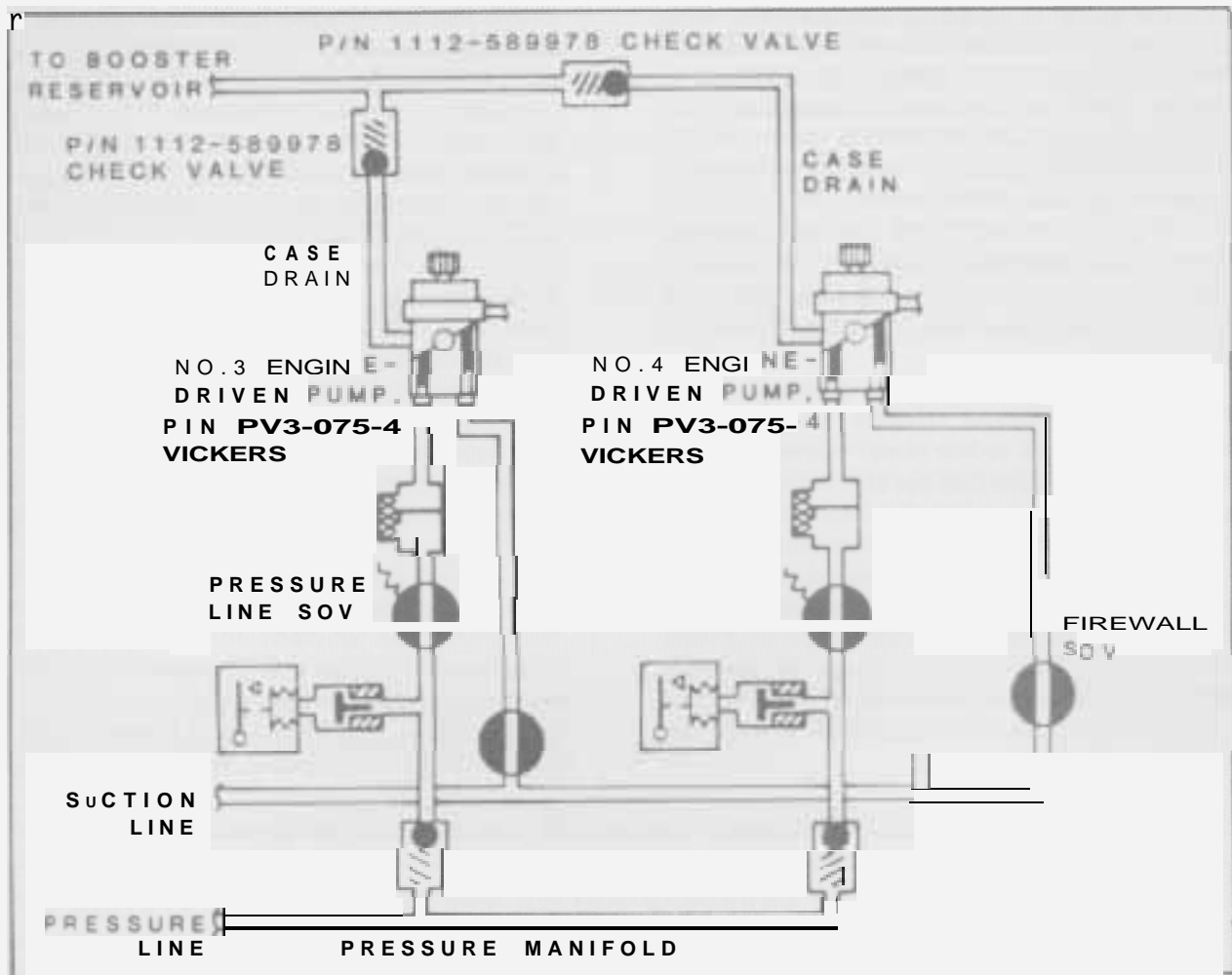

Figure 4. The baseline configuration of LAC 4458 to LAC 4652 | ne ~~float~~ valves have been replaced by check valves.

pumps (Figure 5). The P/N 66039 Abex pump contains a thermal off-stroke feature which allows it to be used in any of the four hydraulic plumbing configurations we have previously described. It can be used with or without a bypass loop, and with either a relief valve or check valve in the case drain line. The baseline configuration starting with LAC 4653 and presently in effect uses the 66039 Abex pump, no bypass loop, and a 1112-589978 check valve in the case drain line.

Note that once again this change pertained only to those airplanes being built for operators other than the U.S. Air Force. Lockheed continued to install NYAB or Vickers pumps on U.S. Air Force C-130s until a fiscal year 1982 contract provided for the use of Abex pumps on aircraft designated for the U.S. Air Reserve Forces.

A customer buying Hercules aircraft today might think that his aircraft would automatically come with the baseline configuration; i.e., Abex pumps, no bypass loops, and 1112-589978 check valves. He would be right if he had never bought a Hercules before, or if he had bought Hercules airlifters previously that were equipped with Vickers or Abex

pumps. But there is another possibility.

If a repeat customer originally bought Hercules aircraft equipped with NYAB pumps, Abex pumps with bypass loops and 695903-3 relief valves would be installed on the subsequent aircraft purchase (Figure 6). This would provide the customer with a Hercules fleet in which NYAB or Abex pumps could be used interchangeably.

### Other Pumps

We have already mentioned that U.S. Air Force C-130s were originally equipped with NYAB or Vickers pumps prior to the fiscal year 1982 Air Reserve Forces buy. The Air Force went one step further and procured a number of modified Vickers pumps with the part number PV3-075-4A as replacement parts. Some C-130s in the Air Force inventory will therefore be equipped with this pump. The difference between the PV3-075-4A Vickers pump and the PV3-075-4 model that was installed on baseline Hercules aircraft between LAC 4430 and LAC 4652 are relatively minor. The -4A pump has a displacement of 0.60 cubic inch per revolution and will deliver

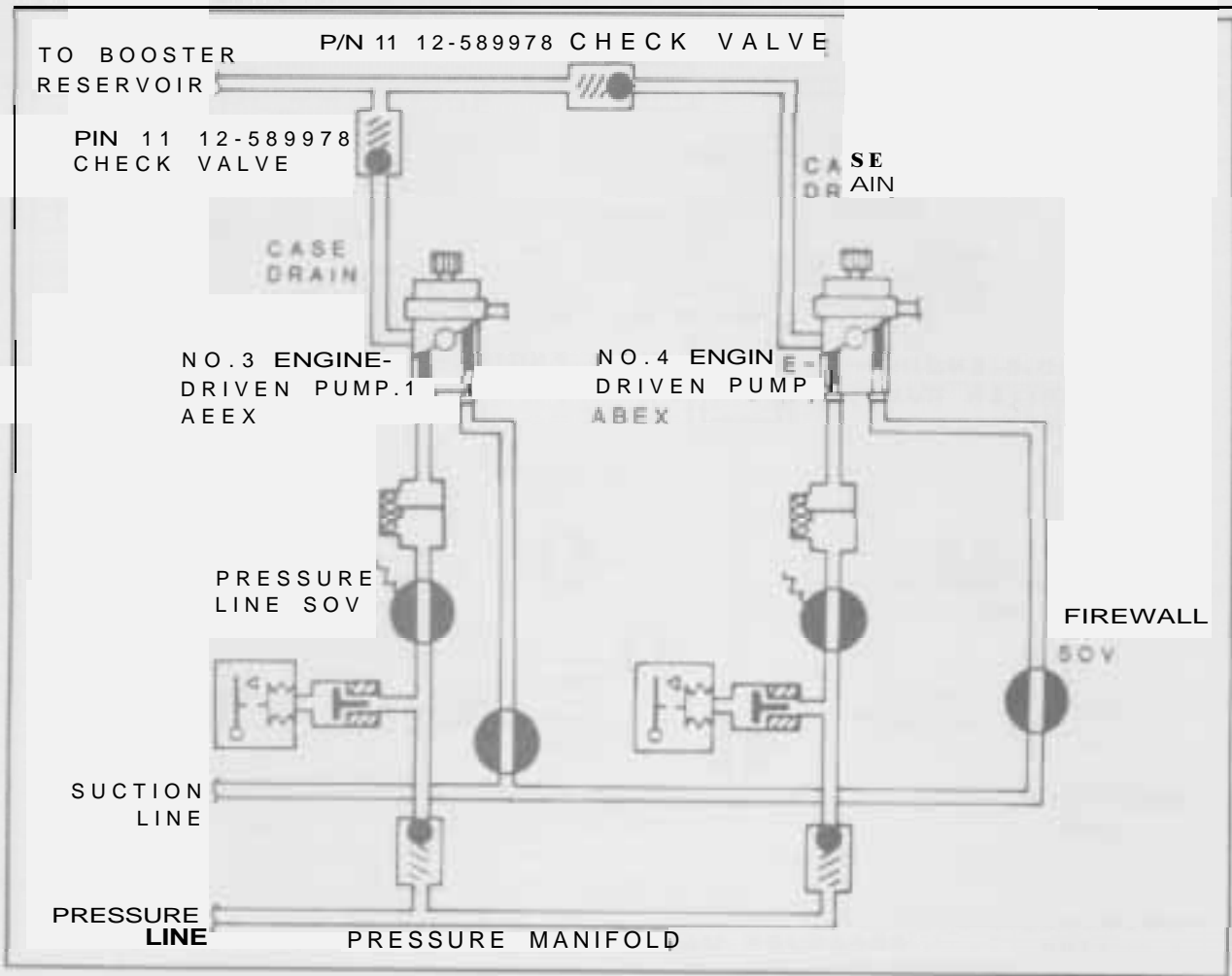

Figure 5 The Abex pump was introduced at Hercules aircraft LAC 4653 No changes were required in the basic system design.

approximately 8.6 gallons per minute. The -4 Vickers pump has a displacement of 0.75 inch per revolution and delivers approximately 10.7 gallons per minute.

Lockheed has approved the use of another Vickers-built pump, one which up to this time has not been installed on any new Hercules aircraft. The Vickers P/N PV3-075-16 engine-driven hydraulic pump incorporates a thermal off-stroke feature like the Abex pump. This allows it to operate in any of the plumbing configurations that we have previously discussed; that is, with or without a bypass loop, and with a relief valve or a check valve in the case drain line. At this time, the U.S. Air Force is modifying some Vickers -4A pumps to the -16 configuration; some new -16 Vickers units are also being procured as spares.

It can be seen from the foregoing discussion that as far as the engine-driven pumps are concerned, the normal hydraulic system plumbing configurations found on Hercules aircraft offer considerable latitude in terms of interchangeability. Briefly stated, the conditions governing the interchangeability of engine-driven hydraulic pumps are as follows: Always use a bypass loop and 695903-3 relief valve with any NYAB pump. Omit the bypass loop with a Vickers -4 or -4A pump and use either a 695903-3 relief valve or a 1112-589978 check valve in the case drain line. Finally, any of the standard plumbing configurations can be used with the 66039 Abex pump or the -16 Vickers pump. The table below shows this same information in graphic form.

PUMP	BYPASS LOOP	P/N 695903-3 RELIEF VALVE OR P/N 1112-589978 CHECK VALVE	
		RELIEF VALVE	
NYAB	YES	RELIEF VALVE	
VICKERS -4	NO	EITHER	
VICKERS -4A	NO	EITHER	
VICKERS -16	OPTIONAL	EITHER	
ABEX	OPTIONAL	EITHER	

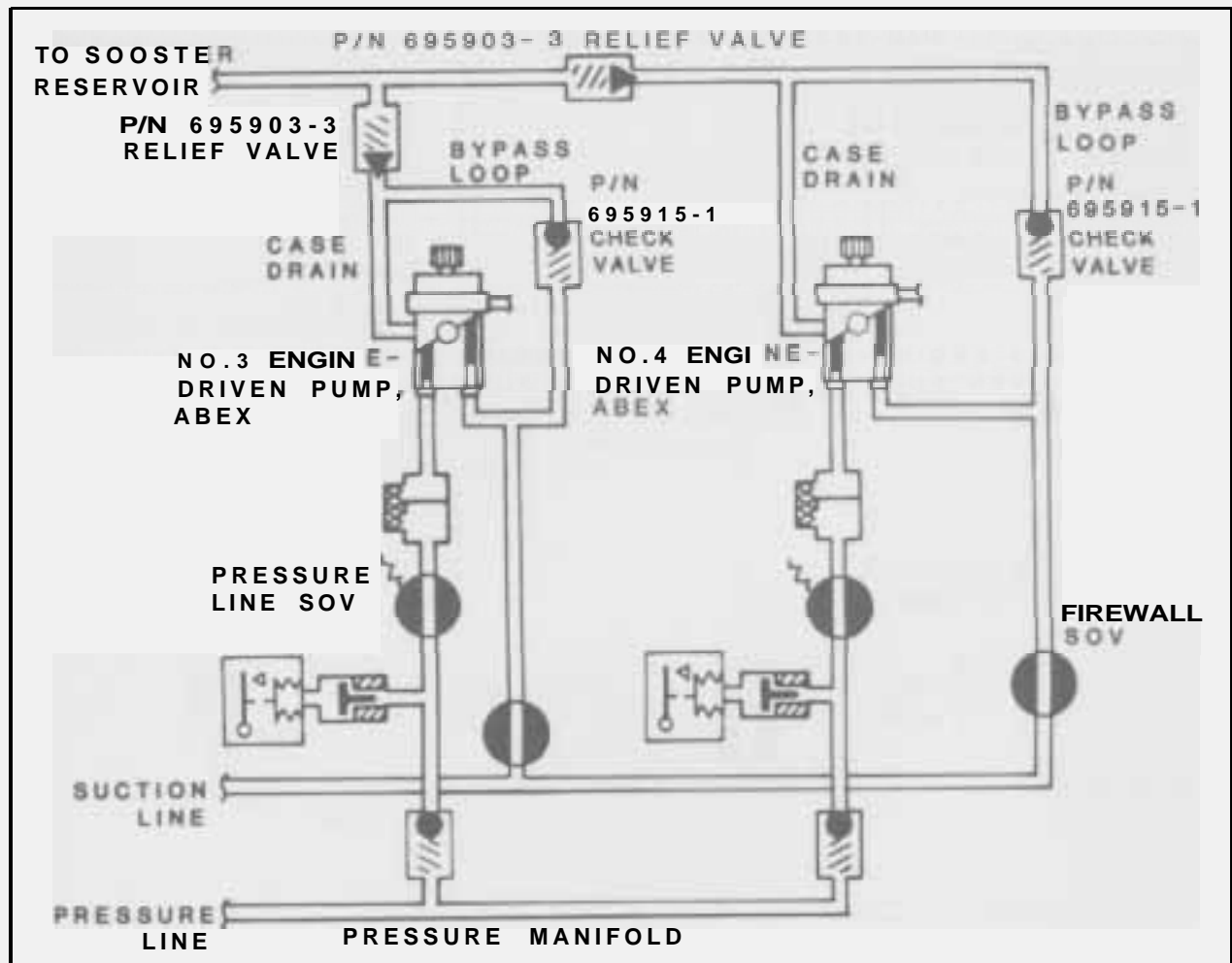

Figure 6. System plumbing configured for use with either NYAB or Abex pumps.

### Operational Notes

We would like to mention here that there are two characteristics that the flight crew will notice if a NYAB engine-driven hydraulic pump is replaced with a -4 or -4A Vickers pump (with the appropriate plumbing change), a -16 Vickers pump, or an Abex pump.

First, the NYAB pump is of a design often referred to as a “check valve” type pump. It will allow suction boost pump pressure (approximately 100 psi) to flow through a static engine-driven pump to operate the flight controls, albeit at a very reduced rate. The Vickers and Abex pumps, which are commonly referred to as “in-line” type pumps, will not allow suction boost pump pressure to flow through a static engine-driven pump.

Second, if the flight crew turns off the suction boost pump, the output pressure of a rotating NYAB engine-driven pump will drop, as evidenced on the affected system’s pressure gage. The primary reason for the pressure drop is that a compensator is referenced to the pressure in the suction line; if suction line

pressure is reduced, output pressure drops. The compensators on Vickers and Abex pumps are referenced to case pressure and are therefore theoretically insensitive to suction line pressure. There will nevertheless be a very slight drop in pressure on the gage with Vickers or Abex pumps when the suction boost pump is not operating. This pressure drop is caused primarily by a slight reduction in case drain pressure when suction pressure is switched off.

### The C-130A

We have not up to this point made any mention of the engine-driven hydraulic pumps of the C-130A. The reason is that the interchangeability of pumps on the A-model Hercules aircraft is not governed by the internal lubricating characteristics of the pump themselves. C-130As, originally equipped with NYAB pumps, have a bypass valve connecting the pressure and suction lines (Figure 7). The bypass valve will open to allow lubricating flow through the pump anytime the engine-driven pump switch is placed to OFF or the fire emergency handle is pulled. This plumbing configuration never changes, regardless of the type of replacement pump that might later be installed.



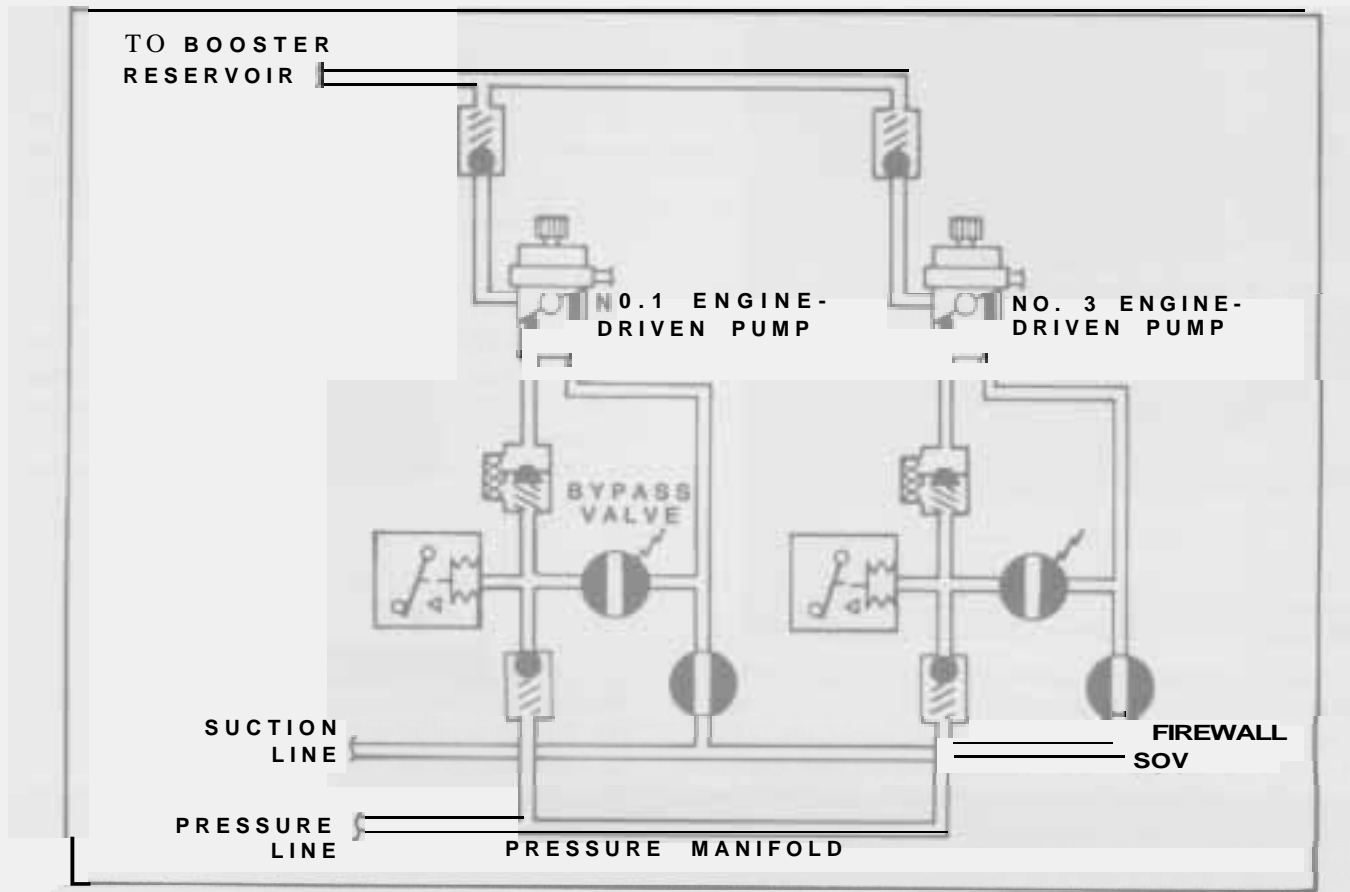

Figure 7. C-130A plumbing configuration; note bypass valves

We hope that this short history of the engine-driven hydraulic pumps used in Hercules aircraft has cleared up any confusion you might have had concerning their application and interchangeability. If the guidelines

that we have laid out here are followed whenever a pump is to be replaced, there should never be any worry about installing a pump in an aircraft with the wrong plumbing configuration.

**SERVICE NEWS**

## Aft Cargo Door

# Actuator Modification

An incident occurred recently aboard a Hercules aircraft on a military training mission that could have had serious consequences for both the aircraft and its crew.

After a paratroop, the aft cargo door switch was left in the neutral position and the emergency manual release cable was used to close the cargo door. Unfortunately, air had become trapped in the associated hydraulic lines and the heavy door dropped suddenly and with considerable force. This applied excessive stress to the structure supporting the upper end of the cargo door actuating cylinder at FS 968, causing it to fracture.

In itself, this would not have resulted in anything more serious than an inoperable door system. But the bleed valve on the actuating cylinder snagged one of the elevator control cables that run beneath it as it dropped, causing the aircraft to assume a nose-down attitude. The aircraft did not prove uncontrollable, however, and landed safely.

To avoid any possible repetition of this type of problem, Lockheed engineering recommends that two actions be taken by Hercules aircraft operators. First, if there is a bleed valve on the aft cargo door actuating cylinder of any of your aircraft, it should be replaced with a bleed plug. Lockheed engineering will soon



Aft cargo door actuator. Note the protruding bleed valve.

issue Service Bulletins SB 82-532 and 382-29-6, "Bleed Plugs - Aft Cargo Door - Bleed Valve Replacement," which describes replacement of the bleed valve. The bleed plug, which is used in place of the bleed valve on all current production Hercules, is too short to foul the elevator cables should the aft cargo door actuating cylinder become loose for any reason.

The second recommendation is that Hercules aircraft operators who have not accomplished Service Bulletins SB 82-299 or 382-093, "Doors - Installation of Snubber and Attaching Structure on the Aft Cargo Door," do so as soon as possible. These service bulletins install a snubber on the aft cargo door which will prevent the door from dropping too rapidly when it is allowed to close of its own weight.



## Life Raft Vent Valve Positioning

by Phil Dick, Specialist Engineer

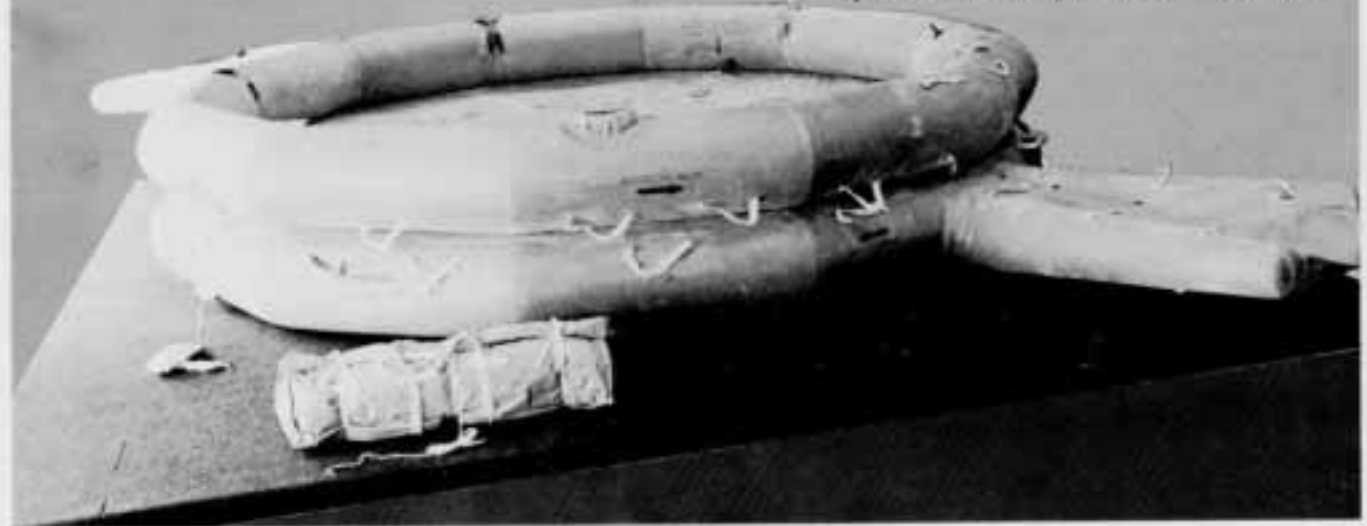

Many Hercules aircraft are equipped with four type F-2B 20-man life rafts stowed in four compartments built into the upper surface of the center wing section. From time to time, Lockheed receives a report of an inadvertent deployment of a life raft during flight. Such incidents are cause for concern that goes beyond the value of the lost equipment. A life raft released in-

to the slipstream can damage or foul empennage surfaces on its way aft.

It is clear that most cases of inadvertent life raft deployment come about because a life raft becomes partially inflated and forces open the life raft compartment access door. What is less clear is just how

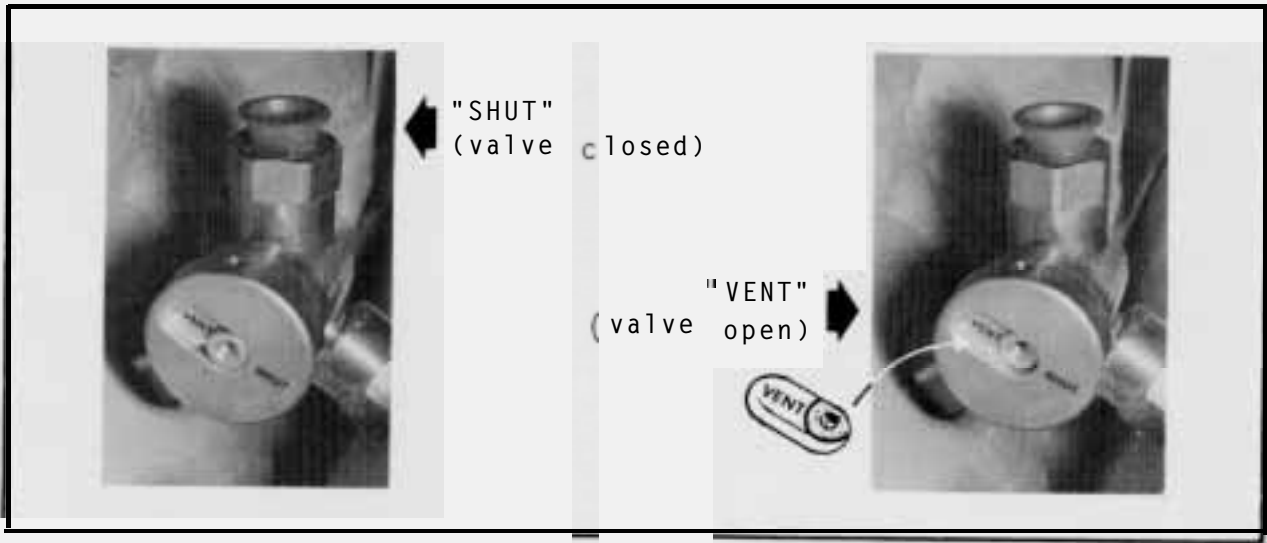

**Figure 1. Vent valve positions.**

this partial inflation occurs. Lockheed engineering has long suspected that the majority of these unscheduled life raft deployments occur either because the raft was incompletely evacuated prior to installation, or because the P/N 9153 vent valve on rafts so equipped has been left in the closed position. Figure 1 illustrates the appearance of the vent valve in both the closed (SHUT) and open (VENT) positions.

It is very important that the vent valve be left in the open (VENT) position once the life rafts are installed in their compartments. The porosity of the life raft material will not permit the raft to remain evacuated indefinitely, and venting of the raft is therefore required to avoid expansion at altitude. Also, if the vent is left closed, any leakage from the CO2 cylinders used to inflate the rafts for use cannot escape to the atmosphere and will enter the raft itself.

Additional evidence has recently come to light which tends to underscore the role that improper positioning of the vent valve plays in these life raft incidents. During a recent investigation of an inadvertent life raft deployment on a C-130H, the life raft compartments of several in-service Hercules aircraft were inspected at random. In one airplane, a life raft was discovered with the vent valve in the closed

position. The raft appeared to have been properly evacuated and installed, except for the valve position, but the access door clearly showed signs of damage. Each time the aircraft went to altitude, the air trapped in the raft expanded, pushing on the door latches. How long the raft had been installed could not be determined, but loss of the life raft appeared imminent because of bending of the door latches.

In an effort to reduce the chance that a vent valve will be left in the closed position after installation of the rafts in their compartments, Lockheed has added a decal (Figure 2) to the life raft access doors on new production airplanes which shows the proper positioning of the vent valve. The Lockheed part number of the decal is 3319712-1, and it is installed in a space on the access doors next to the existing decals which describe how to fold the life raft.

For detailed information on life raft handling procedures, see the applicable maintenance manuals for your airplane and T.O. 14S-1-102/TM5-4220-202-14 for the raft. Also see an in-depth article on life rafts which was presented in Vol. 6, No. 1 of Lockheed Service News (January-March 1979). This article describes air evacuation, installation, and rigging procedures and precautions.

**SERVICE NEWS**

**Figure 2. Part number 3319712-1 decal incorporated on production Hercules aircraft LAC 4917 and up.**





The design of the Hercules aircraft main landing gear is straightforward and its operating cycle relatively simple, especially when compared with the considerably more complicated mechanical cycles required to accomplish gear retraction and extension on many other large aircraft. This functional simplicity helps ensure that the components of the system will be able to provide long service and dependable performance under a wide variety of operational conditions. It should be remembered, however, that every mechanical system is built with certain "normal" operational parameters in mind. Unusually heavy service or severe climatic conditions impose stresses that tend to shorten component life and precipitate special maintenance problems. The Hercules main landing gear is not immune from such effects.

Recently, a military operator whose Hercules aircraft were in virtually continuous operation carrying heavy loads into areas where extreme weather conditions prevailed noted a significant increase in discrepancies involving excessive axial play in the MLG upper bumper stop assemblies. Some of the ballscrew assemblies had only recently been installed and were apparently in good condition otherwise.

Investigation determined that in each of the cases the ring spring assembly had jammed, which accounted for the excessive axial clearance. The exact cause of the condition was more difficult to pinpoint, but it appears that heavy loads, harsh climatic condi-

tions, and inadequate lubrication all played a part. In any event, it proved possible to repair most of the affected upper bumper stops, using a simplified procedure which did not require removing them from the airplane. This resulted in a considerable saving in both downtime and expense. The particular aircraft involved happened to be equipped with Western Gear ballscrew assemblies, but since the Calco ballscrews are essentially similar in construction and function, a discussion of the procedures that can be used to restore jammed ring spring assemblies to service should be helpful to all Hercules aircraft operators.

Whenever excessive axial clearance is discovered in a MLG upper bumper stop, the possibility that a jammed ring spring assembly may be the cause should be considered. A worthwhile initial step is to try to free it without disassembly. Look for a lubrication fitting on the upper bumper stop housing. If one is provided, pump MIL-G-81322 grease into the bumper stop with a grease gun. Then give the bumper stop a sharp blow or two with a rubber or leather mallet. If this frees the spring and the excessive axial play disappears, no further action is required other than periodic lubrication with MIL-G-81322 grease.

If the above steps do not succeed in unjamming the spring, the upper bumper stop can be partially disassembled for inspection and possible on-the-aircraft repair of the ring spring assembly. The following upper bumper stop ring spring separation pro-

cedures in effect combine information now found piecemeal in several technical manuals.

### Western Gear Procedure

Install a ground safety lock on one ballscrew on each side of the airplane and on the nose landing gear. Install a main landing gear strut lock on the strut that is being worked on and jack the aircraft. Remove the insulation blanket located on the inside of the cargo compartment at the MLG wheel well to gain access to the vertical torque shaft access door (Figure 1). After taking off the door, disconnect the vertical torque shaft by removing the four bolts on the torque shaft coupling assembly. Then remove the pillow block and shims by taking out the four bolts that attach it to the fuselage structure. Use a standard gear puller to compress the parts in the upper bumper stop housing, and remove the bumper stop retainer ring from the top of the upper bumper stop housing (Figure 2) with a pair of external snap-ring pliers. Now lower the upper bumper stop housing. Be *careful*: Jammed ring spring elements can separate spontaneously and forcefully without warning; stay alert to the possibility and keep fingers and tools clear.

When the ring spring assembly is exposed, check to see if the spring elements are still stuck together. If they are, you should be able to separate them by lightly tapping on the outer ring with a mallet. Once the elements are freed, examine them for corrosion, scored surfaces, nicks, chipped mating surfaces, and broken parts. Serious damage will require that the ring spring assembly be replaced, which should be done in the shop after removal of the ballscrew assembly from the airplane.

Minor damage can be much easier to correct. If corrosion is only minor and there are no signs of permanent physical damage, the only repair that will be necessary is to clean all grease from the mating surfaces of the ring spring elements and remove any corrosion with emery cloth. Avoid "polishing" the

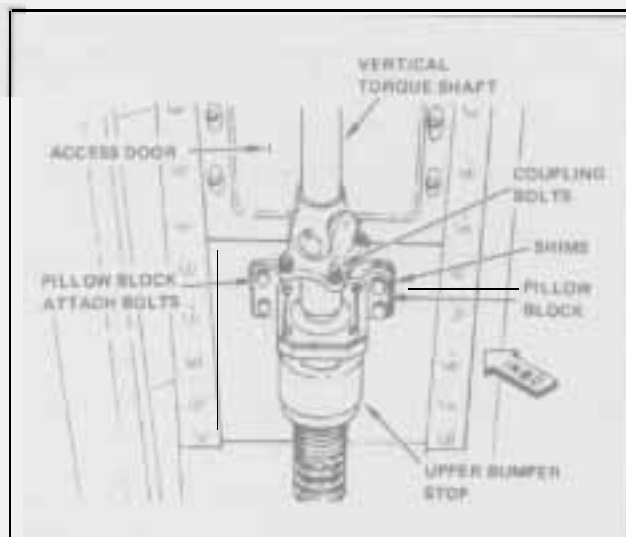

**Figure 1.** Remove the access door to reach the vertical torque shaft and the upper bumper stop.

elements, and protect the other parts of the ballscrew assembly from falling debris while you work.

Before reinstalling the ring spring assembly, lubricate the elements of the ring spring assembly liberally with MIL-G-81322 grease. Insert the ring spring elements, the spacer, and the bearing into the upper bumper stop housing. Press the upper bumper stop housing upward on the ballscrew with a standard gear puller and install the bumper stop retainer ring. Rotate the ring in its groove on the bumper stop housing to ensure positive seating.

Reinstall the original pillow block and shims, and reconnect the torque shaft and the ballscrew. Be sure to install all of the coupling bolts head-down and safety-wire all four castellated nuts.

Next, synchronize the ballscrews as outlined in the appropriate landing gear maintenance manual. Then reinstall the vertical torque shaft access door and the insulation blanket. Remove the main landing gear

**Figure 2.** Exploded view of the Western Gear upper bumper stop.

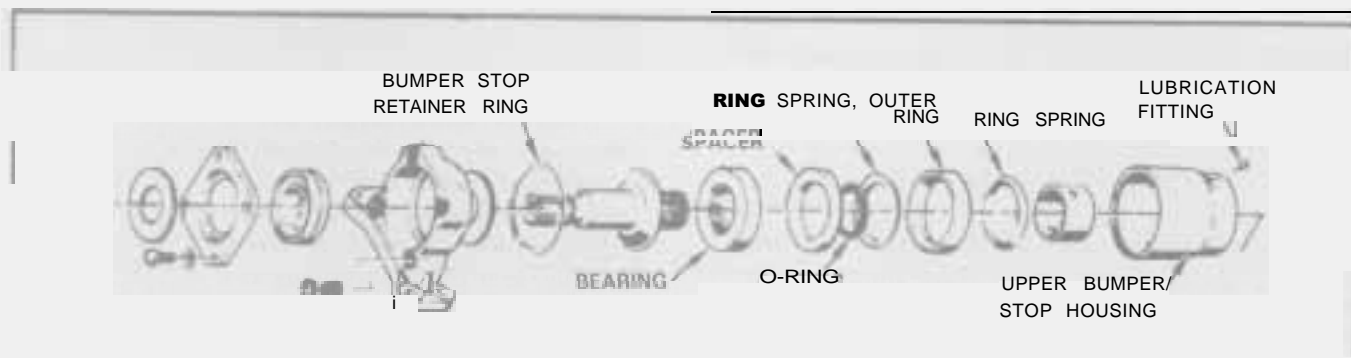

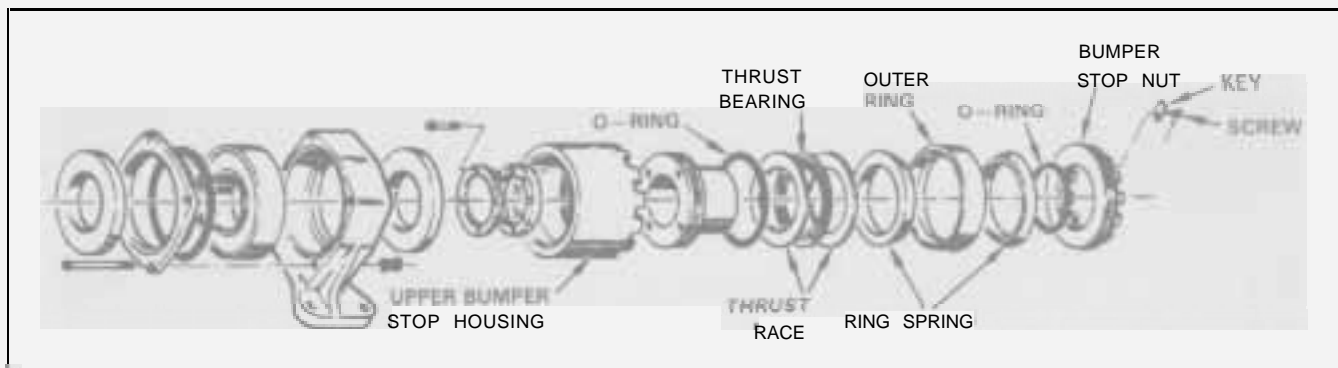

**Figure 3. Exploded view of the Calco upper bumper stop.**

strut lock and the ground safety locks and perform an operational check of the MLG in accordance with the landing gear maintenance manual. The repair is now complete. Reinstall the nose landing gear ground safety lock, lower the airplane, and remove the jacks.

### Calco Procedure

The steps required to free a jammed ring spring assembly in a Calco upper bumper stop are in many ways similar to those used for Western Gear units. There are, however, some differences in design details between the two units and these are reflected in this repair procedure.

Install a ground safety lock on one ballscrew on each side of the airplane and on the nose landing gear. Install a main landing gear strut lock on the strut that is being worked on and jack the aircraft.

It is not necessary to detach the pillow block from the fuselage structure to gain access to the ring spring assembly. Remove the safety wire, the screw, and key from the upper bumper stop nut (Figure 3). Use a strap wrench to keep the upper bumper stop housing from rotating, and screw the upper bumper stop nut out of the housing. Now lower the ring spring assembly, the thrust races, and the thrust bearing. *Be careful:* If the ring spring elements are jammed, they can separate spontaneously and with great force; use appropriate precautionary measures.

Note the condition of the upper bumper stop O-rings. If they appear to be deteriorated, the ballscrew assembly should be removed for inspection of the O-rings.

Inspect the ring spring assembly to determine if the spring elements are still jammed. If they are, tap the outer ring lightly with a mallet to free them. After the elements are separated, check them for corrosion, scored surfaces, nicks, chipped mating surfaces, and broken parts. If any significant damage is present, the

ring spring assembly must be replaced, which should be done in the shop after removal of the ballscrew from the airplane.

In cases where only minor corrosion is found, the only repair required will be to clean the mating surfaces of the ring spring elements carefully and remove any corrosion with emery cloth. Don't "polish" the elements, and protect the other parts of the ballscrew assembly from any foreign particles that may become loosened while you work.

Begin assembly by applying a liberal coat of MIL-G-81322 grease to the thrust bearing, thrust races, and the ring spring elements. Coat the threads of the bumper stop nut with MIL-T-5544 anti-seize compound. Install the thrust races, thrust bearing, and ring spring assembly into the upper bumper stop housing and screw the upper bumper stop nut on finger tight.

Now tighten the nut to a value of 250 inch-pounds. Further tighten the nut to align the locking slots on the nut and on the housing, but do not exceed 400 inch-pounds of torque. After the slots are aligned, install the key and the screw and safety wire the screw.

Next, remove the MLG strut lock and the ground safety locks from the landing gears. Perform an operational check of the landing gear in accordance with the landing gear maintenance manual. The repair is now complete. Install the nose landing gear ground safety lock; then lower the airplane and remove the jacks.

While we don't suggest that the steps we have discussed here will take care of all of your ballscrew problems, the information we have presented should prove helpful in many situations. When a jammed ring spring is all that keeps a Hercules aircraft main landing gear from performing as it should, it is both quicker and less expensive to repair it than to requisition and install an entire new ballscrew assembly.

# PROTECTING UHF and VHF BLADE ANTENNAS

by A.D. Wing, Service Representative

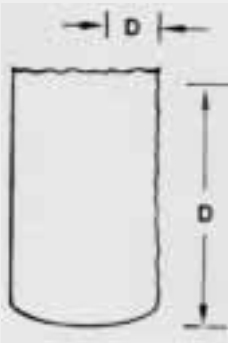

1. MEASURE

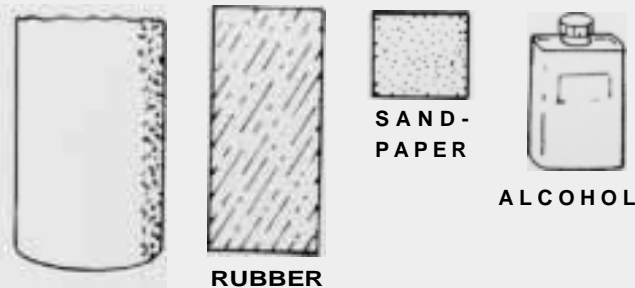

2. SAND & CLEAN

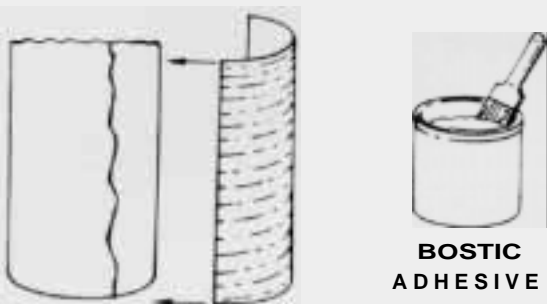

3. APPLY ADHESIVE AND RUBBER



4. FINISHED



The leading edges of the blade-type UHF and VHF antennas located on the lower part of the Hercules aircraft fuselage are often gradually eroded by sand, gravel, and other solid particles tossed up by the propellers and nose wheels during landings and ground operations. Ice crystals and hail encountered in flight can also cause significant wear and tear on these surfaces.

A simple but effective approach to protecting the leading edge of an antenna of this type is to glue on a strip of rubber cut from an old inner tube. The rubber strip should be large enough to overlap 3/4 inch to 1 inch on each side of the antenna leading edge, and it should be long enough to run the full length of the antenna. Both the antenna and the rubber strip need to be prepared for adhesion by roughening the surfaces that will be in contact. Use medium-grade sandpaper for this purpose, and then clean the surfaces with solvent. Alcohol is a good choice because it leaves no residue.

Any strong adhesive can be used to cement the rubber strip to the antenna leading edge. One recommended brand is Bostic No. 1096, used with Boscodur No. 9 accelerator. Be sure to follow the manufacturer's instructions carefully to ensure maximum adhesion and durability.

 *Lockheed-Georgia Company*

CUSTOMER SERVICE  
LOCKHEED-GEORGIA COMPANY  
A Division of Lockheed Corporation  
Marietta, Georgia 30063

