

Second Printing November 1981
VOL. 5, NO. 1, JANUARY - MARCH 1978

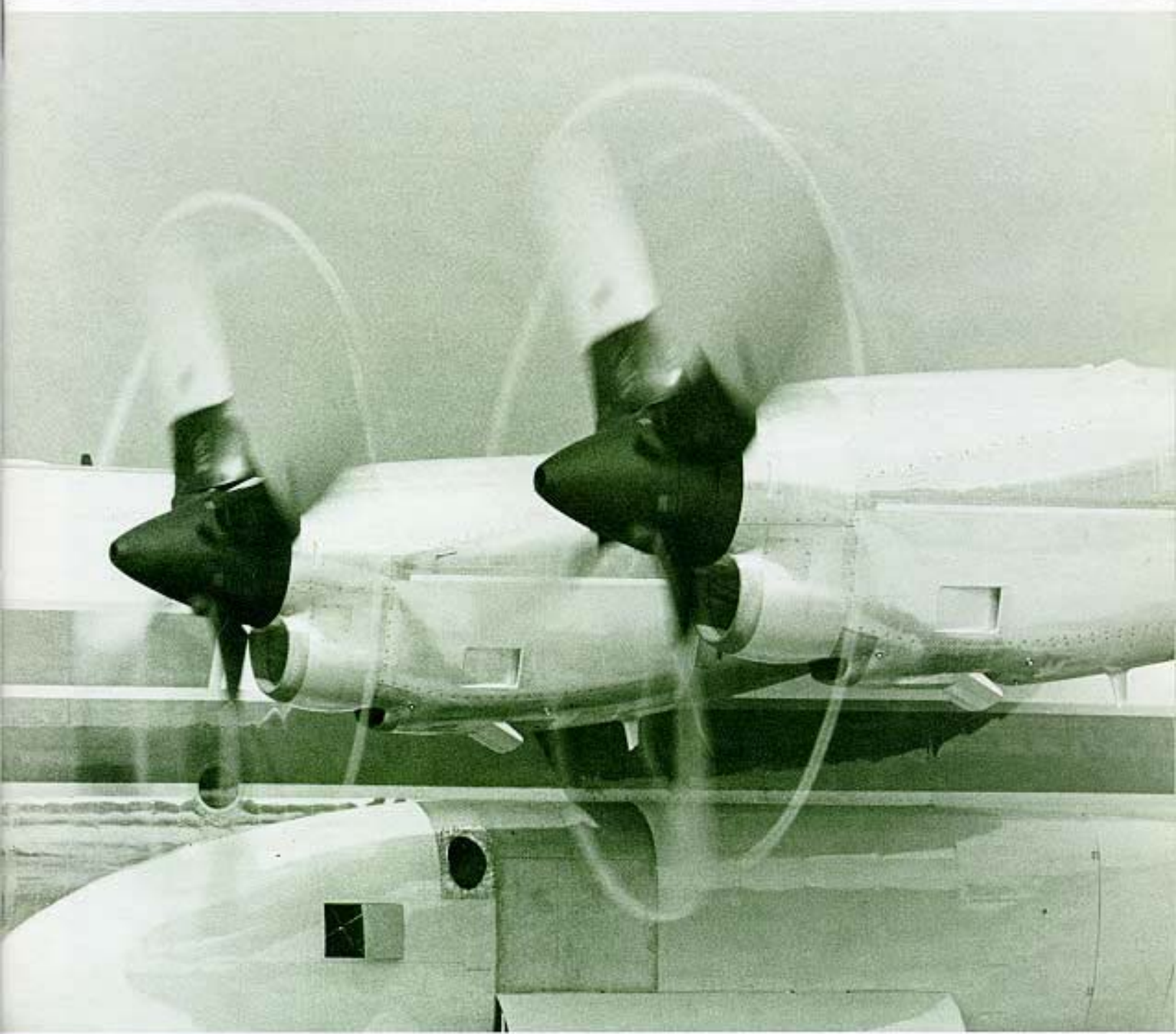

SERVICE NEWS

A SERVICE PUBLICATION OF LOCKHEED-GEORGIA COMPANY, A DIVISION OF LOCKHEED CORPORATION



Power Plant Rigging

SERVICE NEWS

A SERVICE PUBLICATION OF
LOCKHEED-GEORGIA COMPANY
A DIVISION OF
LOCKHEED CORPORATION

Editor

Jay V. Roy

Associate Editors

Charles I. Gale
Don H. Hungate
James A. Loftin

Art Direction & Production

Anne G. Anderson

SERVICE NEWS



Cover: Water vapor condenses in the partial vacuum behind whirling Hercules propeller tips as number 1 and number 2 engines are put through their paces during ground runup.

Published by Lockheed-Georgia Company, a Division of Lockheed Corporation. Information contained in this issue is considered by Lockheed-Georgia Company to be accurate and authoritative. It should not be assumed, however, that this material has received approval from any governmental agency or military service unless it is specifically noted. This publication is for planning and information purposes only, and it is not to be construed as authority for making changes on aircraft or equipment, or as superseding any established operational or maintenance procedures or policies. The following marks are registered and owned by Lockheed Corporation: "Service News", "Lockheed", "Hercules", and "JetStar". Written permission must be obtained from Lockheed-Georgia Company before republishing any material in this periodical. Address all communications to Editor, Service News, Department 64-22, Zone 278, Lockheed-Georgia Company, Marietta, Georgia, 30063. Copyright 1978 Lockheed Corporation.

Vol. 5, No. 1 January - March 1978

CONTENTS

- 3 Hercules **Power Plant Rigging**
- 4 Section 1: Control System Checkout
- 7 Section 2: Throttle and Condition Cable Rigging
- 11 Section 3: QEC Cable Rigging and Condition Lever Preload Adjustment
- 14 Section 4: Coordinator to Propeller Rigging
- 16 Section 5: Coordinator to Fuel Control Rigging
- 19 Section 6: Static Propeller Adjustments

23 Aircraft Wheel Inspection

Emphasizing Inspection of Critical Areas

24 Index By Subject

Vol. 1, No. 1 Through Vol. 4, No. 4

26 Corrections

27 Index By Issue

Vol. 1, No. 1 Through Vol. 2, No. 4

28 Index By Issue

Vol. 3, No. 1 Through Vol. 4, No. 4

DIRECTOR T.J. CLELAND

MANAGER D.L. BRAUND

FIELD SERVICE & INVENTORY MGMT A.H. McCRUM

CUSTOMER TRAINING E. L. PARKER

JETSTAR SUPPORT H.L. BURNETTE

SPARES STORES & SHIPPING J.K. PIERCE

MANAGER M.M. HODNETT

SUPPLY PROCUREMENT R.C. WEIHE

SUPPLY SYSTEMS & INVENTORY CONTROL C.K. ALLEN

SUPPLY SALES & CONTRACTS H.T. NISSLEY, JR.

SUPPLY TECHNICAL SUPPORT J.L. THURMOND

HERCULES

POWER PLANT RIGGING

by **William H. Wood**, *Training Specialist*
Charles I. Gale, *Associate Editor*

Correct rigging of the engine mechanical control system is essential for safe and efficient operation of the Hercules power plants. The control system is simple and straightforward in design, and has proved to be very reliable in service. It must, of course, be maintained in correct adjustment to ensure that the various components linked by the system will operate properly in relation to each other.

In practice, frequent adjustments to the rigging are not generally necessary. Once the engine control system has been set up properly, it will usually stay in adjustment and continue to function smoothly with only routine maintenance as long as it is not disturbed.

Sooner or later, however, repair or replacement of one or more of the engine components connected by the system will require that the linkages be removed, and the correct alignment is likely to be lost. It follows that whenever a propeller has been changed, or after replacement or repairs to the coordinator, fuel control, or any part of the linkage, the affected portion of the control system must be rerigged; and the operation of the entire system should be checked.

The importance of correct engine rigging cannot be overemphasized. Misadjustment of any part of the rigging system can lead to operational discrepancies which may masquerade as elusive component failures and cause no end of trouble. It sometimes happens that hours are spent in futile troubleshooting of nonexistent prop, fuel control, coordinator, or even indicator problems, only to have it turn out in the end that the cause of the complaint was a misrigged engine.

Such incidents are frustrating and costly, and they are also unnecessary. Hercules power plant rigging procedures are not difficult to understand or perform; and time spent reviewing them can pay substantial dividends in terms of improved performance, increased component life, and simplified troubleshooting. It is



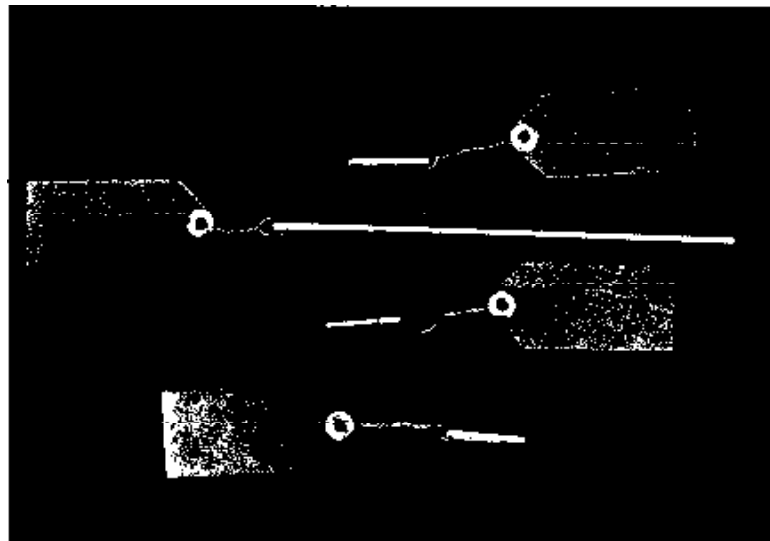

Provide all rigging pins with prominent red warning tags.

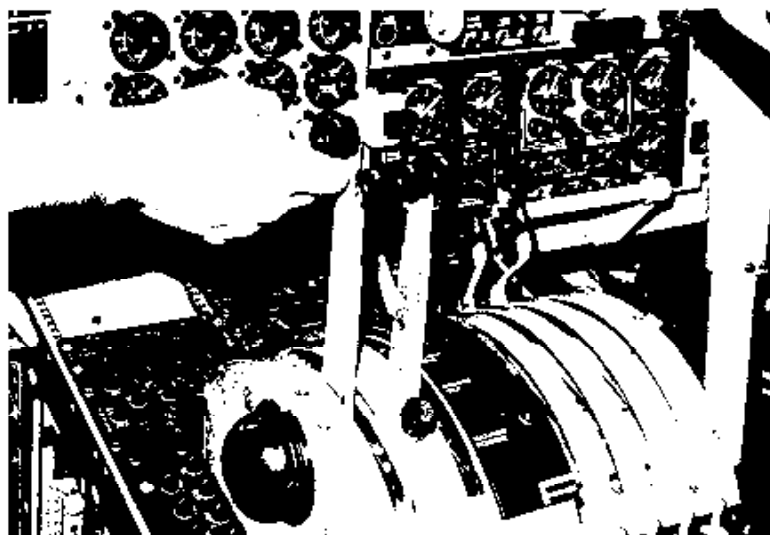

Checking throttle lever for free movement at the flight idle gate.



No. 1 engine throttle cable tension regulator indicating between 7 and 8.

with this in mind that the following material is presented. **Please note that the procedures outlined here are intended only as an aid to understanding the engine mechanical control system and the effect of adjustment upon its operation. Always refer to the appropriate technical publications and follow approved procedures in making any adjustments to the power plant rigging.**

TOOLS

Hercules power plant rigging procedures require a few special tools. Before you begin checking the engine mechanical control system, be sure that the following are available :

- Two 1/4-inch diameter rig pins, approximately 8 inches in length
- Two 1/4-inch diameter rig pins, approximately 1 1/4 inches in length
- One 3/16-inch diameter rig pin, about 1 1/4 inches in length
- Two Hamilton Standard No. HS 9903 propeller alignment pins; or two No. 546455 three-step propeller alignment pins and one No. 546456 two-step propeller alignment pin
- One position fixture No. 6796658
- One Type C-8 cable tensiometer, or equivalent
- One 15-pound capacity spring scale

If otherwise unavailable, the rig pins may be fabricated from smooth steel rods of the correct diameter. Be **certain that all rig pins and alignment pins are provided with large red warning tags.** This will help avoid the possibility that a rig pin might be left in place by mistake.

There should also be someone available who can assist you while you are carrying out the various rigging procedures. Your partner's primary job will be to move the controls in the flight station as necessary while the positions of the coordinator pointer and the propeller indexing lever are being examined at the engine.

SECTION 1

Control System Checkout

Each segment of the engine mechanical control system may be individually checked and adjusted; but if you need to determine whether a control system problem does in fact exist, or if you have just completed repairs

to the system and wish to check total function, a complete system checkout should be performed.

Try to carry out the following checkout procedure as described. If you are unable to complete any of the checks, write down the nature of the discrepancy and in what portion of the system it has occurred. Then refer to the section of this article containing detailed rigging procedures for the affected part of the system.

Begin your system checkout procedure with a check of the throttle control rigging. Raise the throttle lever you wish to check about $\frac{3}{4}$ of an inch at the flight idle gate and let it fall. It should fall freely with no binding or interference.

Next, go back to the cargo compartment and look at the scale reading on the appropriate cable tension regulator for the engine in question. The scale should indicate between 7 and 8 at temperatures ranging from 45 to 105 degrees F.

Now place all four throttle levers in FLIGHT IDLE. Insert a long $\frac{1}{4}$ -inch diameter rig pin through the hole in the left side of the control quadrant cover and into the throttle levers. On some aircraft you will need to remove the ash tray on the side of the quadrant in order to uncover the rig pin hole. The throttle levers will also have to be lifted a little to line up the holes in the levers with the one in the quadrant.

Insert another long $\frac{1}{4}$ -inch diameter rig pin through the bracket and the pulleys under the floor of the flight station. Access to the lower pulley assembly is through the aft center access panel in the nose wheel well.

The $\frac{3}{16}$ -inch diameter rig pin should now be inserted through the throttle cable pulley and bracket at the fire seal of the engine being checked. In each case where you are to install a rig pin, the rig pin holes should be aligned closely enough so that the rig pins can be installed without difficulty. Shaking the cables slightly may help line up the holes in case there is a little misalignment at any of the rigging points.

Next, remove all of the rig pins in the system and, with the condition lever in RUN, have your assistant go to the flight station and move the throttle of the engine you are testing to the TAKEOFF position. Check the reading at the coordinator protractor on the engine. The pointer should indicate $90 (+/- 1)$ degrees.

Now insert a three-step propeller alignment pin through the takeoff slot in the index bracket on the propeller valve housing and into the indexing lever. The pin should fit through the slot easily.

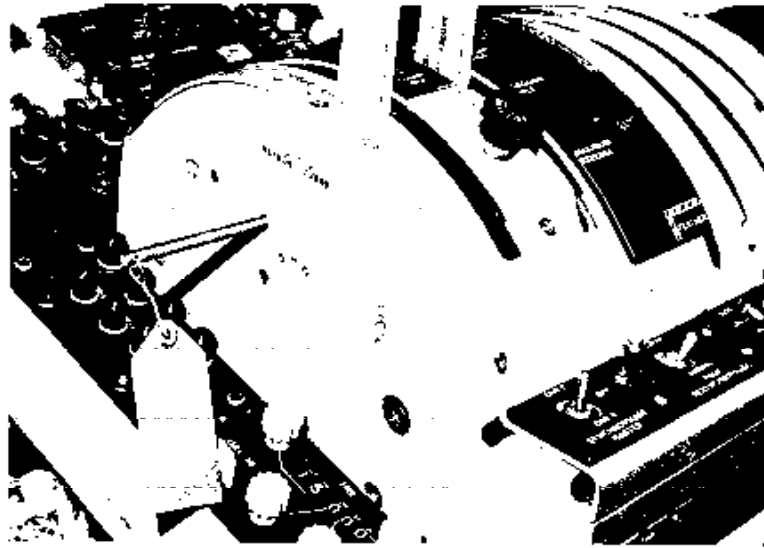

Throttle levers pinned at FLIGHT IDLE.

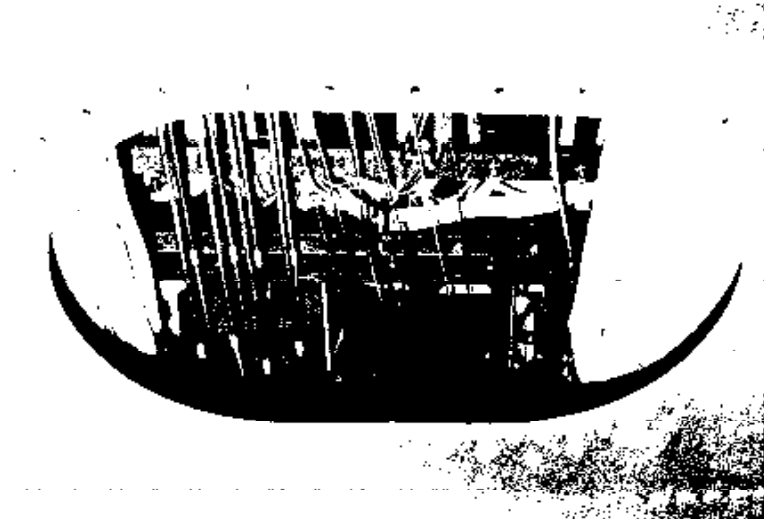

Access to the lower pulley assembly under the flight station.

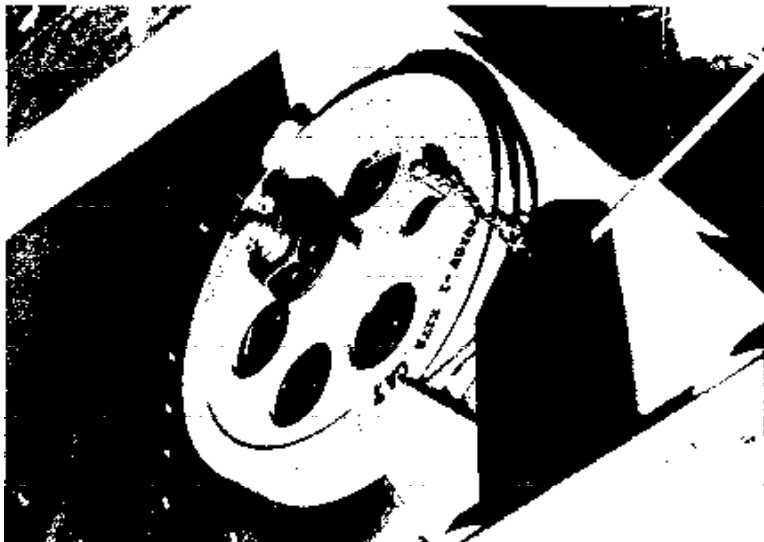

Throttle cable pulley pinned at the fire seal.

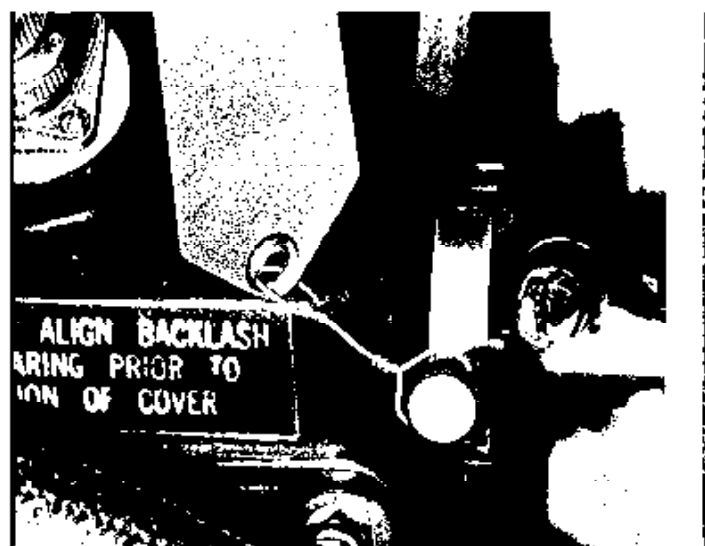

Propeller indexing lever pinned at flight idle.

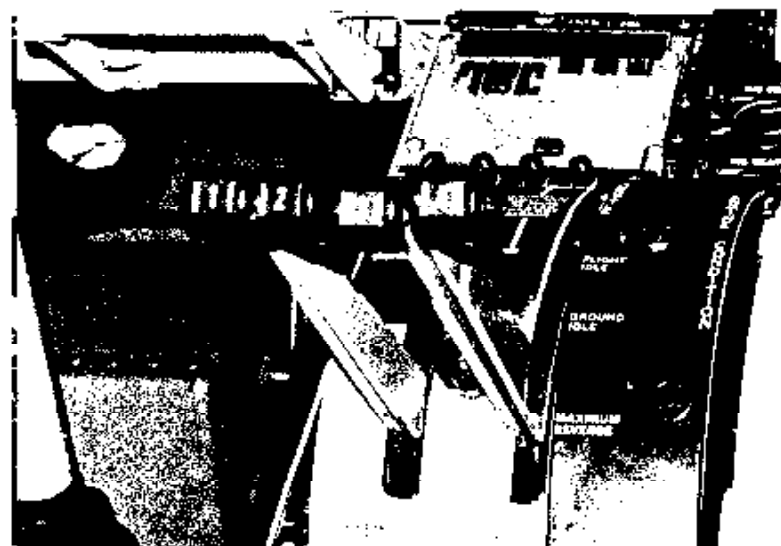

Throttle levers lined up at MAXIMUM REVERSE.

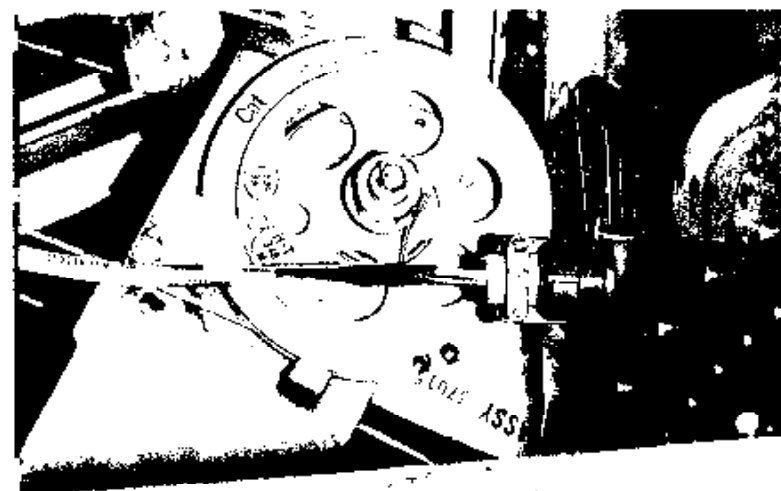

Note lack of rig pin hole alignment at fire seal condition control pulley with condition lever in FEATHER and correct QEC cable preload applied.

Remove the alignment pin and have the throttle pulled back slowly but smoothly until it is against the flight idle gate. Check the reading at the coordinator pointer. The pointer should indicate not more than 35 degrees.

Return to the propeller index bracket and try to fit the three-step alignment pin through the flight idle slot of the bracket and into the indexing lever. The pin should fit through the slot without difficulty.

Remove the alignment pin and have the throttle moved to TAKEOFF. Instruct the person assisting you to pull the throttle lever back briskly, within one second. Now check the coordinator protractor again. It should indicate not less than 34 degrees.

Next have the throttle moved to MAXIMUM REVERSE and note the reading on the coordinator protractor. The pointer should be at 0 (+/- 1) degree.

Go up to the propeller index bracket and try to fit the alignment pin through the maximum reverse slot and into the indexing lever. It should go in easily.

Remove the alignment pin and return to the flight station. Move all four throttles to the TAKEOFF position and check the alignment of the throttles in relation to each other and to the quadrant. The four throttle handles should be within one-half of a knob diameter of being in alignment with each other, and each throttle should be stopped at least 0.2 inches from the end of the slot.

Move all four throttles to the MAXIMUM REVERSE position and perform the same check—the four throttle levers should line up with each other within one-half knob, and each throttle should be at least 0.2 inches from the end of the slot. This completes the check of the throttle system.

To accomplish a check of the condition control system for any engine proceed as follows: First check the cable system from the control quadrant to the engine fire seal to make certain that there is no binding or interference in the cables and pulleys, that all turnbuckles are properly safctied, and that all guard pins are in place.

Now have the condition lever moved to the RUN position and check the scale reading on the appropriate condition cable tension regulator in the cargo compartment. The reading should be between 6 and 7 for an ambient temperature of 40 to 100 degrees F.

Have the condition lever placed in FEATHER and examine the fire seal condition control pulley for wear. A 3/16-inch diameter rig pin hole is provided in this

pulley for checking the airplane condition control cable length; however, with the QEC attached and the correct preload on the cables the pulley hole will not line up with the hole in the fire seal bracket. If the system checkout turns up evidence of misadjustment in this cable run, it will be necessary to relieve the QEC cable preload before a check at the fire seal condition control pulley can be made. Section 2 of this article contains the details of this procedure.

With the throttle lever in the FLIGHT IDLE position, and the condition lever still in FEATHER, check to see that the condition transfer clevis on the back of the coordinator is firmly against the feather stop.

Now go forward to the propeller index bracket and check to see that the three-step alignment pin can be easily inserted through the feather slot in the indexing bracket and into the indexing lever.

Remove the alignment pin; then take hold of the condition control pulley on the coordinator and rotate it clockwise to force the indexing lever to move away from the feather slot. Release the pulley and check to see that the lever returns to the feather position.

Now return to the flight station and use the spring scale to check that the force required to move the condition lever into the feather detent is 8 to 13 pounds.

If the condition transfer clevis is against the external feather stop when the condition lever is in FEATHER, if the alignment pin can be inserted into the indexing lever through the feather slot of the index bracket, and if the condition lever is properly preloaded with 8 to 13 pounds tension, the condition control system from the fire seal to the propeller is properly adjusted.

The final part of the system checkout procedure is to check for excessive wear of the throttle pulley gimbal ring and yoke. Attempt to wobble the pulley assembly back and forth. The total back and forth movement at the rim should not exceed 3/32 of an inch.

If this checkout procedure has revealed a rigging problem, refer to the applicable section of the following discussion for detailed adjustment procedures.

SECTION 2

Throttle and Condition Cable Rigging

If the control system checkout procedure in Section 1 has revealed evidence of a rigging problem in the cable runs between the control quadrant and the QEC, the following procedure may be used to bring the system back into adjustment.

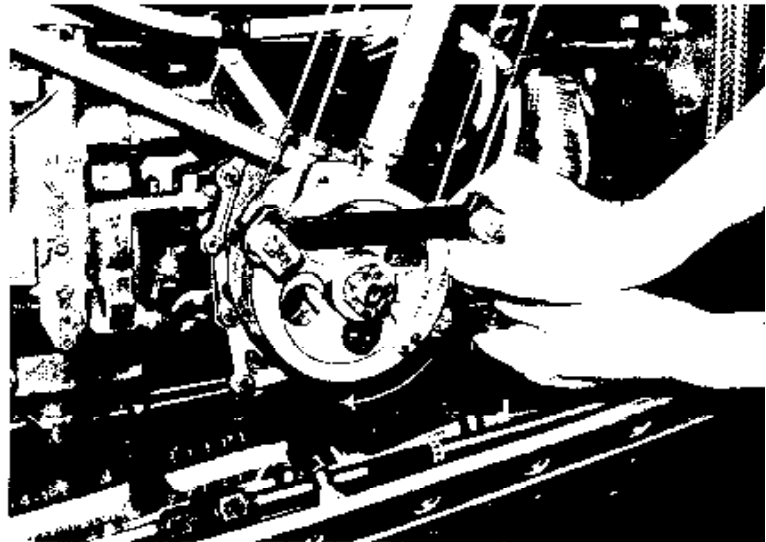

Checking feather preload at the lower condition control pulley.

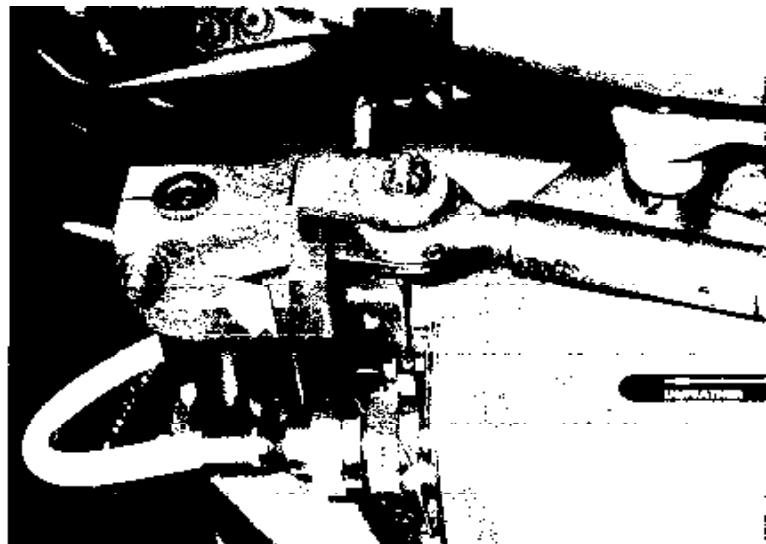

Condition transfer clevis against the external feather stop.

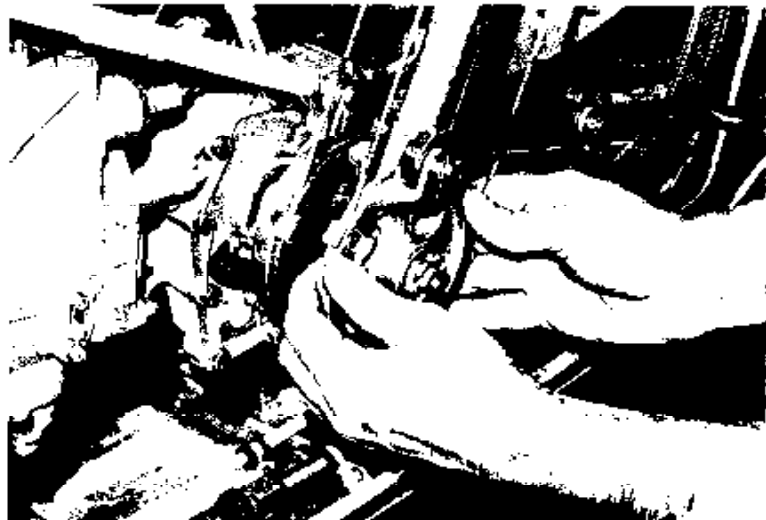

Checking lower throttle and condition control pulleys for wear.

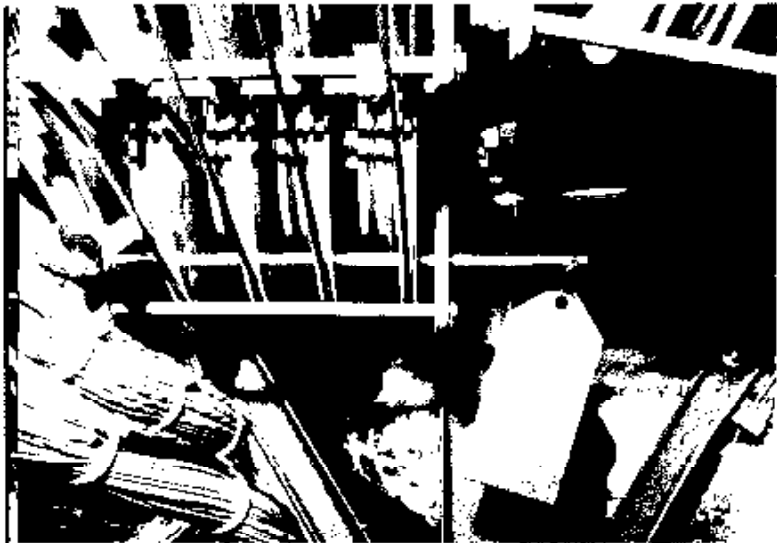

Throttle cable pulleys under the flight station pinned at flight idle.

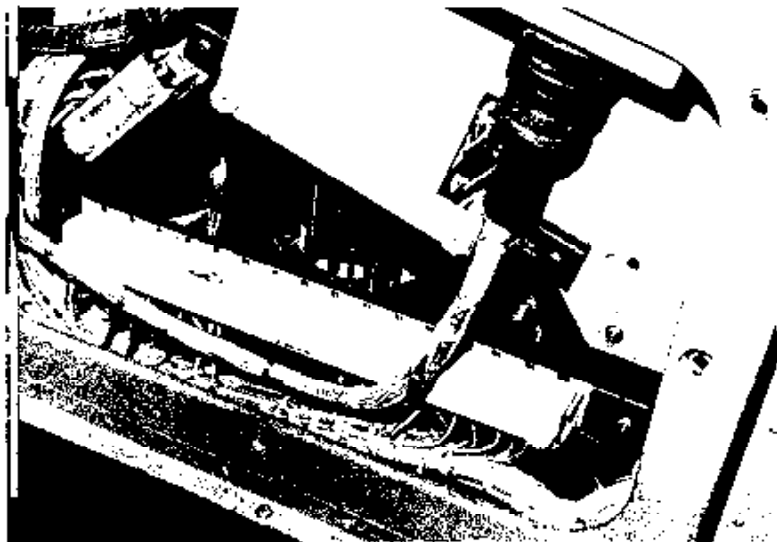

Access to cable turnbuckles in the control quadrant.

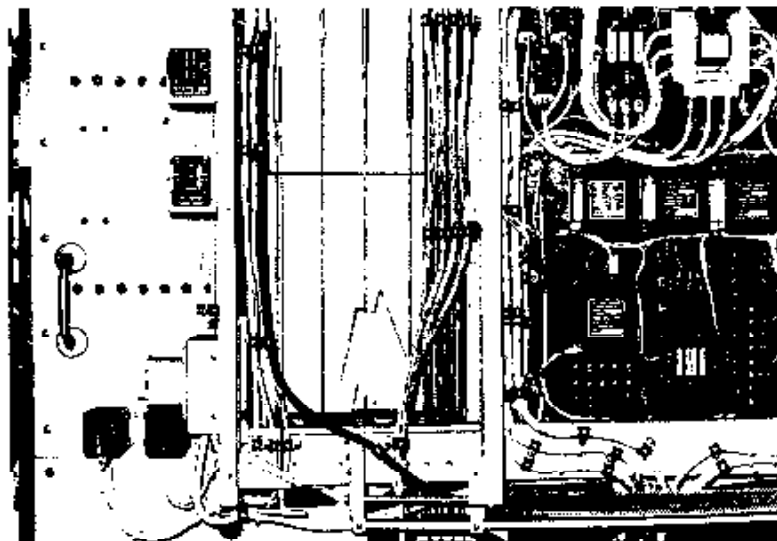

Engine control system cable turnbuckles at the FS 245 bulkhead.

It is convenient to treat the throttle control cable rigging and the condition control cable rigging separately. Let us begin with the adjustment of the throttle control rigging.

There are really two cable runs involved in the airplane portion of each engine's throttle control system. The first is the short one between the throttle lever and the pulley under the floor of the flight station. The second is the longer run from the pulley under the flight station floor to the control cable pulley at the engine fire seal.

To adjust the short cable, first place the condition levers in RUN and then pin the throttle levers in FLIGHT IDLE by inserting one of the long X-inch diameter rig pins through the rig pin hole in the side of the control quadrant.

Now try to install the other long 1/4-inch diameter rig pin in the lower pulley assembly through the hole provided in the lower pulley bracket. You can reach the lower pulley assembly through the aft center access panel in the nose wheel well.

If the rig pin cannot be installed in the lower pulley assembly, adjust the turnbuckles in the quadrant as required to allow the pin to be inserted. Enlist the aid of your assistant for this since the rig pin must be inserted from below the floor, and the turnbuckles can only be reached from the flight station proper.

After the alignment of the rig pin hole is correct, adjust the turnbuckles for a tension of 65(+ 10 -20) pounds, using the C-8 cable tensiometer. The tension should be as nearly equal as possible in both cables, and no more than three threads of the end fittings should show after the correct tension is set.

When the adjustment is complete, add locking clips or safety wire to the turnbuckles. Be careful not to change the cable tension while securing the turnbuckles. The cables are quite short and a small adjustment to the turnbuckles results in a significant change in the cable tension,

To adjust the longer cable run, insert the 3/16-inch diameter rig pin through the rig pin hole in the pulley at the fire seal and into the support bracket. If the pin cannot be installed freely, adjust the cable turnbuckles on the aft side of the 245 bulkhead or overhead near the tension regulators as necessary to allow insertion of the pin. Have your assistant watch the alignment of the rig pin hole as you change the turnbuckle adjustment. For engines 1 and 4, the turnbuckles located in the wing leading edge may be used for this adjust-

ment if desired. Remove the section of the wing leading edge inboard from engines 1 or 4 for access to these turnbuckles.

Check the reading on the scale of the appropriate cable tension regulator. The reading should be between 7 and 8 at ambient temperatures from 45 to 105 degrees F. Also measure the tension in each of the cables with the tensiometer. The tension should be as nearly equal as possible in the cable pair.

If the tension regulator scale does not read between 7 and 8, or if the tension in the cable pair is not equal, adjust any of the turnbuckles in the cable run as necessary to obtain the desired values.

When setting the cable tension with the turnbuckles, adjust the turnbuckles in the two cables alternately in small increments to avoid locking the tension regulator. Try to keep the tension in one cable approximately equal to that in the other cable at all times.

Now remove the rig pins from the throttle quadrant, the lower pulley assembly, and the pulley at the fire seal. Move the throttle lever back and forth from TAKEOFF to MAXIMUM REVERSE five times and then return the throttles to the FLIGHT IDLE position.

Reinsert the rig pin through the throttle levers in the control quadrant and check to see that the proper rig pins can also still be inserted into the lower pulley assembly and the pulley at the engine fire seal. Re-adjust as necessary to obtain an easy fit.

When all three rig pins can easily be inserted and the cable tension is correct, the rigging of the throttle cables is complete.

To adjust the cable rigging of the condition control system properly, it is best to completely separate the QEC control cable system from the airplane control system. First, relieve the preload on the condition control cables by moving the condition lever to RUN; then disconnect both links of the outboard condition control transfer assembly from the lower control pulley. Don't try to do this with the condition lever in FEATHER; the cable preload is transmitted to the pulley and it may rotate suddenly when the links are unfastened.

Now have the condition lever placed in FEATHER and remove the pin that holds the QEC control pulleys engaged with the airplane system pulleys at the fire seal. Slide the QEC system out of engagement. This will isolate the airplane system from the QEC system

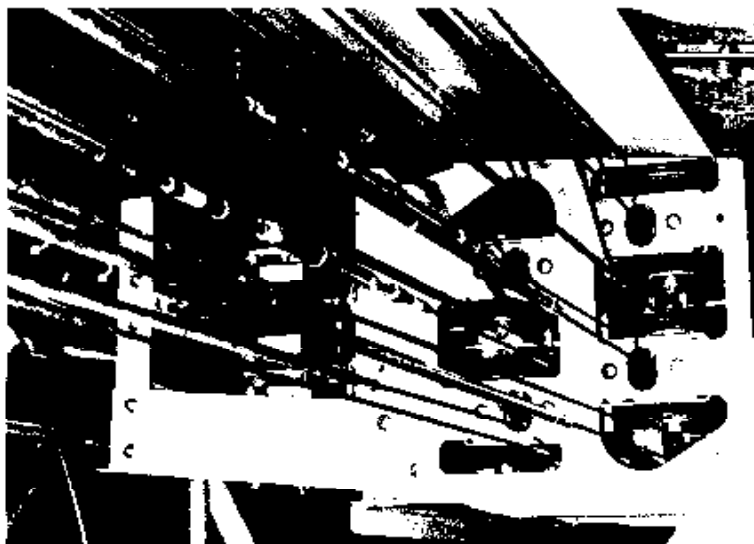

Turnbuckles located overhead in the cargo compartment near the tension regulators.

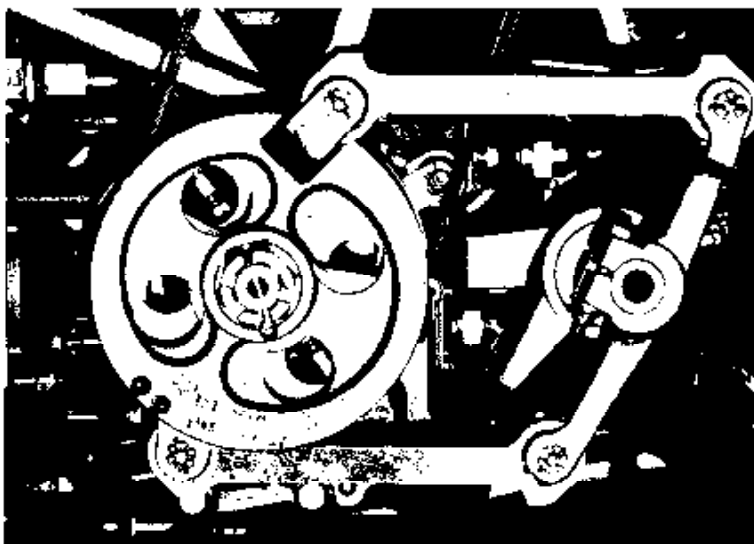

Disconnect the links of the outboard condition control transfer assembly to relieve QEC cable preload.

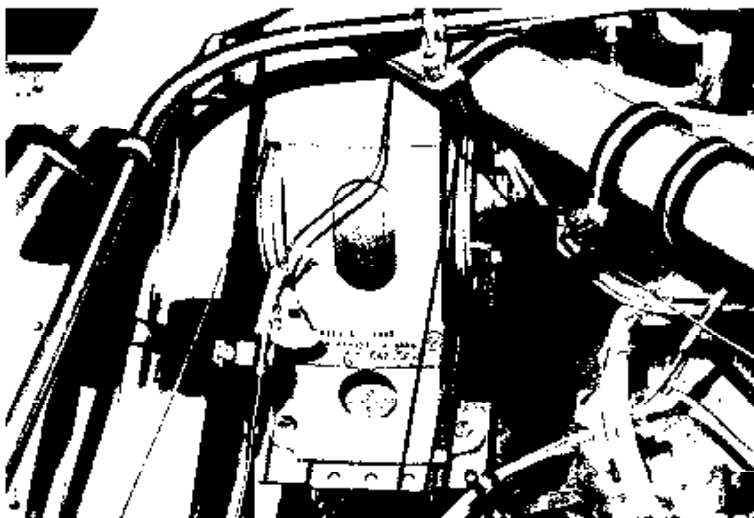

Condition control pulley at the fire seal with rig pin installed.

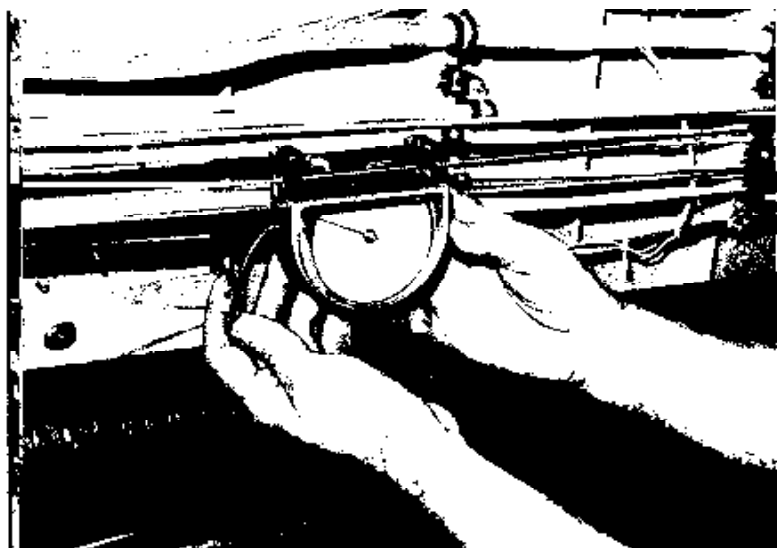

Adjusting cable tension for an outboard engine at the wing leading edge.

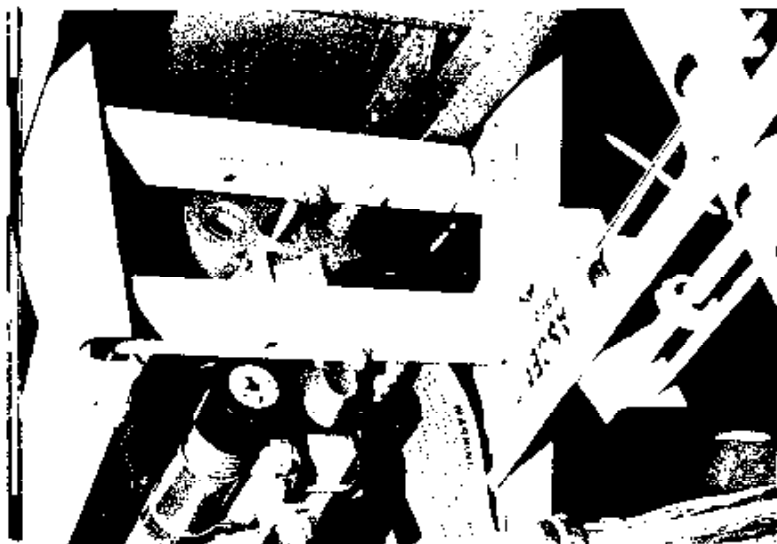

No. 1 engine condition cable tension regulator indicating between 6 and 7.



Cable turnbuckle with properly installed locking clip.

and avoid the possibility that misadjustment or malfunction in one system might affect the operation of the other.

With the condition lever in the flight station still placed in the FEATHER position, try to insert the 3/16-inch diameter rig pin through the hole in the condition control pulley at the fire seal and into the support bracket.

If the pin cannot be inserted easily, loosen any of the turnbuckles in the cable run sufficiently so that the condition control pulley can be rotated to allow the rig pin to be inserted.

With the rig pin installed, adjust the cables for a tension regulator reading of approximately 6.5, depending on the ambient temperature (the proper tension at a given temperature can be determined from the charts in the applicable technical manuals). Adjust the cable alternately in small increments to prevent locking up the tension regulator. Use the cable tensiometer and keep the tension on the two cables as nearly equal as possible while at the same time obtaining the proper reading.

When the cable tension has been adjusted, remove the rig pin from the condition control pulley at the fire seal and have your assistant move the condition lever back and forth from FEATHER to RUN five times, ending up in the FEATHER position.

Attempt to reinstall the rig pin in the control pulley at the fire seal. Readjust the cable turnbuckles as necessary to obtain an easy fit. If any readjustment is required, again have your assistant move the condition lever through its travel five times and recheck for an easy fit of the rig pin. Repeat the procedure as many times as necessary to obtain the desired results.

The airplane condition control system adjustment is complete when the rig pin can be easily inserted in the control pulley at the fire seal, the tension is about 6.5 on the tension regulator scale (depending on temperature), and there is equal tension in the cable pair.

If these conditions have been satisfied, lockclip or safety wire the turnbuckles and reconnect the QEC control system to the airplane system. Remember that in order to return the complete condition control cable system to normal operation you must restore the condition lever preload. This is done through adjustment of the QEC cable rigging and is discussed in Section 3.

SECTION 3

QEC Cable Rigging and Condition Lever Preload Adjustment

The system checkout may have indicated improper adjustment of the QEC control cable system. In such a case, proceed as follows: With the QEC control system connected to the airplane system, observe the movement of the coordinator pointer as the throttle lever in the flight station is moved between MAXIMUM REVERSE and TAKEOFF. The pointer should move through its entire range smoothly and indicate 0 degrees at MAXIMUM REVERSE and 90 degrees at TAKEOFF.

If the coordinator pointer will not reach 90 degrees, or if the pointer moves beyond the 90-degree mark, determine whether the coordinator shaft is turned against its internal stop with the throttle lever at TAKEOFF. It may be necessary to disconnect the linkage that attaches the throttle output lever of the coordinator to the fuel control throttle lever to check this.

The coordinator pointer should read 90 degrees when the shaft is rotated against the internal stop. Loosen the screws which hold the pointer and reposition it if necessary.

If the linkage to the fuel control had to be removed to allow the coordinator to reach its 90-degree stop, the coordinator-to-fuel control rigging is incorrect and should be adjusted according to the procedure outlined in Section 5. However, once the 90-degree position of the coordinator pointer on its shaft has been established and correctly set, you may leave the linkage between the coordinator and the fuel control disconnected temporarily and proceed with the rest of the QEC cable rigging adjustments.

Have the throttle lever in the flight station placed in FLIGHT IDLE, and pin the throttle pulley at the fire seal with the 3/16-inch diameter rig pin. Use the C-8 cable tensiometer to check the tension in the outboard upper control cable and adjust the turnbuckle as necessary to obtain a cable tension of $65(+10 - 20)$ pounds. Remember that with a short cable like this a small adjustment in the turnbuckle makes a considerable difference in the cable tension. Avoid disturbing the setting of the turnbuckle when installing a locking clip or safety wire.

Now check the coordinator pointer and see that it indicates $34(+/- 1)$ degrees. If it does not, adjust the turnbuckles on the inboard lower control cables until the coordinator shows 34 degrees. Adjust the cable tension to $65(+10 - 20)$ pounds while making sure



QECs with pre-rigged control cables ready for installation.

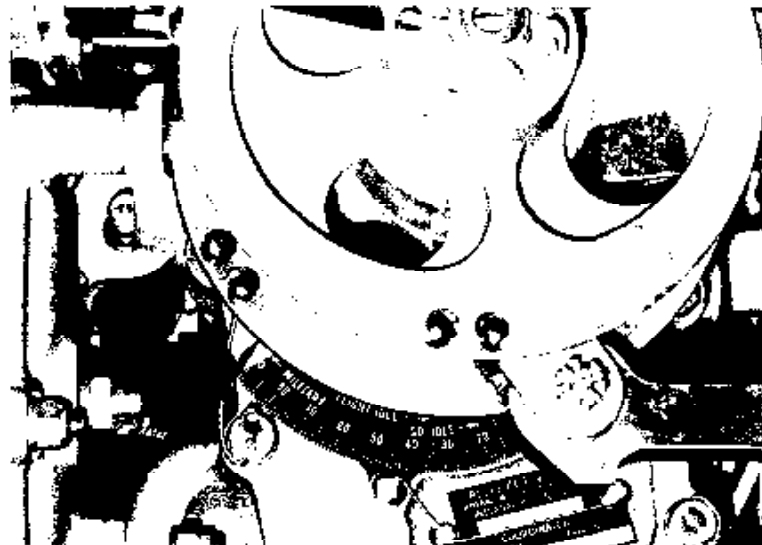

Engine control coordinator at 90 degrees (takeoff).



Indicated link may be disconnected to allow coordinator to reach 90 degrees.

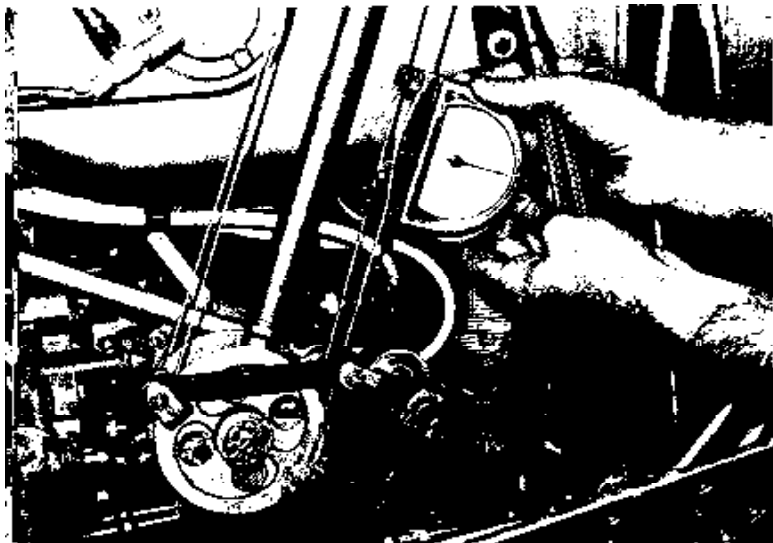

Checking tension in the lower control cables.

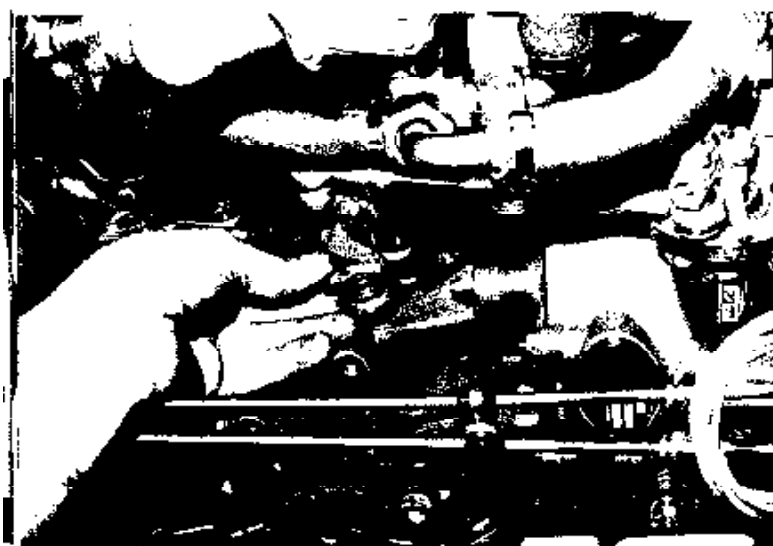

Disconnecting the condition control link.



Propeller indexing lever pinned at feather.

that the coordinator pointer does not stray from indicating 34 degrees. The tension in both cables should be as nearly equal as possible, and no more than three threads of the fittings should be showing out of the turnbuckles when the adjustment is complete.

Now remove the $\frac{3}{16}$ inch diameter rig pin from the throttle pulley at the fire seal and have the flight station condition lever placed in FEATHER. Insert the rig pin through the hole in the condition control pulley and into the support bracket at the fire seal. If there is a preload on the condition lever, it will have to be relieved before the pulley will line up with the hole in the bracket.

Disconnect the condition control link on the inboard side of the coordinator from both the condition transfer clevis and the coordinator condition lever, and set it aside for the moment. Using the C-8 cable tensioner, check the tension of the inboard cable of the upper control assembly. Adjust the turnbuckle as necessary to obtain a cable tension of $65(+10 - 20)$ pounds.

Next, adjust the turnbuckles of the outboard lower control cables as necessary to obtain a tension of $65(+10 - 20)$ pounds with the condition transfer clevis against the feather stop.

Pick up the condition control link and measure it carefully. Adjust the rod ends of the link as necessary to obtain a hole-to-hole center distance of $4\frac{1}{2}$ inches with an equal number of threads showing on both ends and both witness holes covered. When this adjustment is complete, reconnect the link to the coordinator condition lever and to the condition transfer clevis.

Now attempt to insert the three-step propeller alignment pin through the feather slot in the propeller indexing bracket and into the hole in the indexing lever. If the pin can be inserted easily, remove the alignment pin from the indexing lever and the rig pin from the condition control pulley at the fire seal, and proceed with the condition lever preload adjustment.

If the alignment pin cannot be easily inserted into the feather slot of the indexing lever, again disconnect the condition control link from the condition transfer clevis and loosen a jamnut. If the indexing lever had rotated past the feather slot in the indexing bracket, turn the rod end $\frac{1}{2}$ turn to shorten the rod assembly. If the indexing lever had not reached the feather slot in the indexing bracket, lengthen the rod assembly by $\frac{1}{2}$ turn of the rod end. Check to make sure that the witness holes in the barrel are closed, tighten the jamnut, and then reconnect the rod to the condition transfer clevis.

Now try to insert the alignment pin in the indexing lever at the feather position. If the pin still cannot be inserted, repeat the 1/2 turn adjustment of the rod assembly, but with the other end. Continue to adjust the rod as necessary to permit easy insertion of the alignment pin. Make the adjustments in 1/2 turn increments and at alternating ends to maintain an equal number of threads showing at each end. When the pin will fit in easily, check that the witness holes are closed and tighten the jamnuts. If either witness hole is not closed, the rod must be replaced.

Next, remove the alignment pin from the indexing lever and the rig pin from the condition control pulley at the fire seal. Have the condition lever placed in RUN and the throttle moved to MAXIMUM REVERSE, FLIGHT IDLE, and TAKEOFF, and check the alignment of these positions by inserting the alignment pin into the indexing lever through the respective slots in the index bracket. If the alignment pin cannot be easily inserted into all three positions, refer to Sections 4 and 5 of this article. There you will find rigging instructions for the coordinator-to-propeller and coordinator-to-fuel control linkages.

Condition Lever Preload-Use the 15-pound capacity spring scale to check the force required to move the condition lever from RUN to FEATHER. The force should not exceed 7-1/2 pounds through the first 80 degrees of travel, and should increase gradually through the last 20 degrees of travel until the force is 8 to 13 pounds when the condition lever reaches the feather detent.

If the force required to move the condition lever into the FEATHER position is more than 13 pounds, loosen the aft outboard lower control cable in the QEC and tighten the forward cable to obtain proper force. If the force required to move the condition lever into FEATHER is less than 8 pounds, loosen the forward outboard lower control cable and tighten the aft outboard cable; be sure to loosen and tighten the cables in equal increments.

Have the condition lever placed in the RUN position, and check to see that the tension in the outboard lower control cables is still between 45 and 75 pounds. If this is not the case, readjust for this tension and again check to see that the force required to move the condition lever into FEATHER is between 8 and 13 pounds. When this adjustment is complete, leave the condition lever in FEATHER for a moment and check to be sure that the condition transfer clevis is firmly against the feather stop, and the indexing lever at the propeller is properly lined up with the feather slot of the index bracket.



Witness holes must be closed when adjustments are complete.

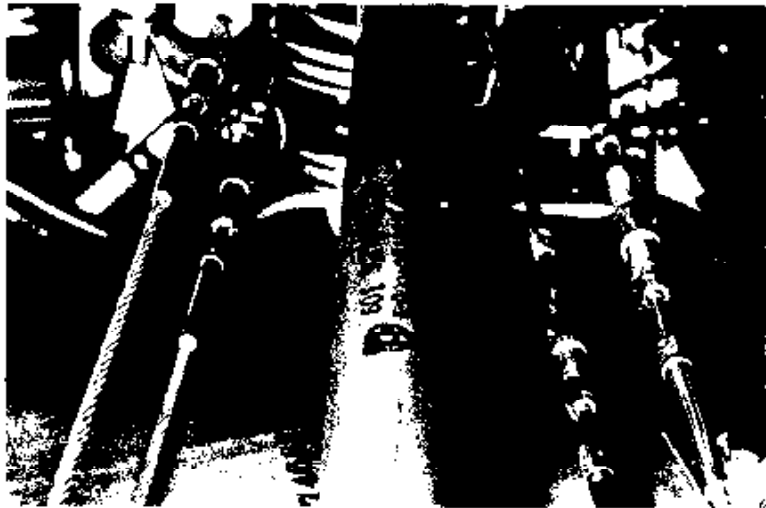

Outboard lower control cable turnbuckles used to adjust condition lever preload.

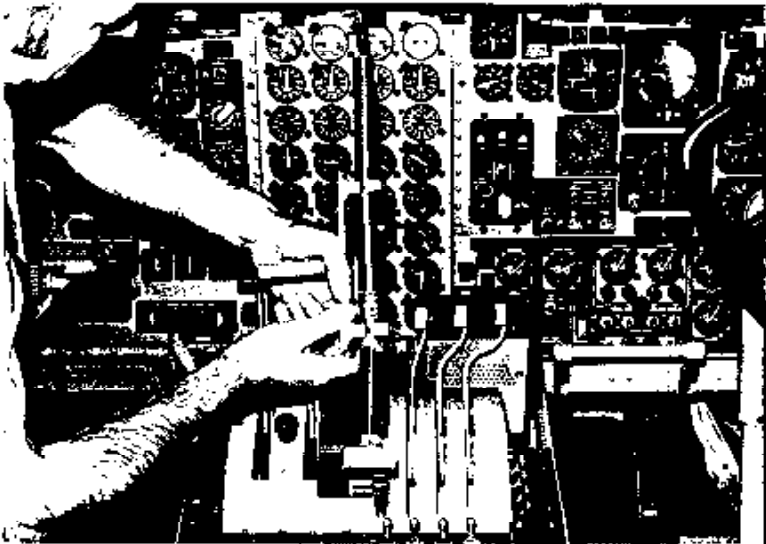

Measuring condition lever preload at the flight station.

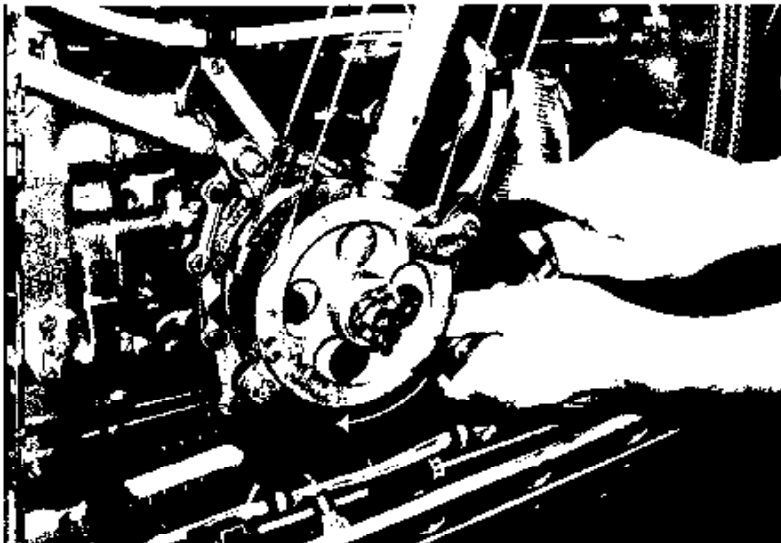

Checking QEC condition cable adjustment with control levers in MAXIMUM REVERSE and RUN.

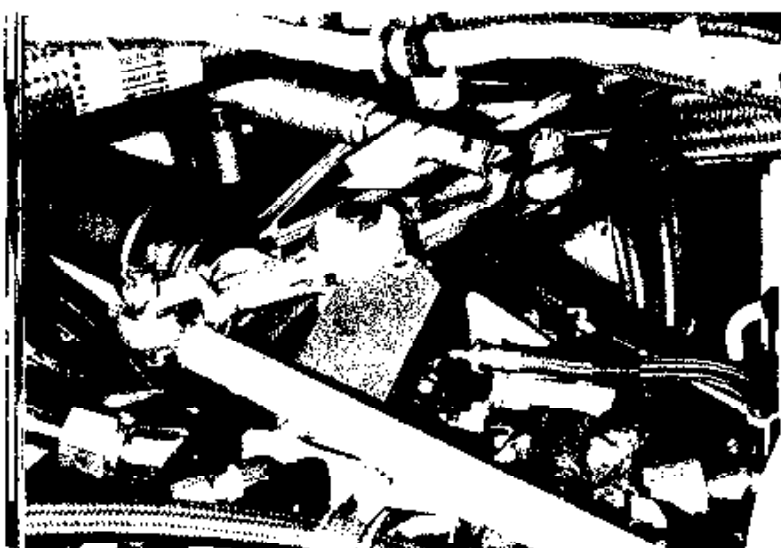

Rig pin installed in propeller control rear lever assembly at flight idle.

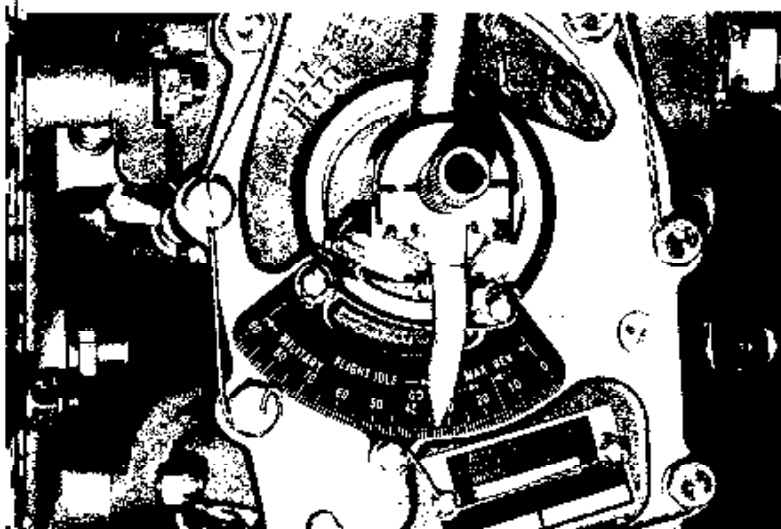

Engine control coordinator at 34 degrees (flight idle). Note screws to allow pointer adjustment.

Now have the condition lever moved to RUN, and the throttle lever moved to MAXIMUM REVERSE. Attempt to fit the three-step alignment pin through the reverse slot of the propeller index bracket and into the indexing lever. If the lever does not align properly, manually rotate the lower control pulley clockwise to bring the indexing lever into alignment. If the lever cannot be brought into the correct position in this manner, the throttle rigging is incorrect and must be checked. If, however, the indexing lever and the reverse slot can be made to align by rotating the pulley, adjust the cable length by loosening the aft lower control cable and tightening the forward lower control cable in equal increments until the slot and the pin hole will remain lined up. Be sure it requires at least 8 pounds of force to place the condition lever into the feather detent when you are through.

Check all turnbuckles for proper lock clip installation or safety wiring, and adjustment. Not more than three threads of each end fitting should be showing out of the barrel. Check all jamnuts for tightness and proper safety wiring. Refer to the applicable technical publications for torque values for the jamnuts. One additional reminder: If it was necessary to unfasten the linkage between the coordinator output lever and the fuel control throttle lever to set the 90-degree indication on the coordinator and it was left disconnected, reconnect it at this time. If adjustment of the linkage is required, refer to Section 5 for the details of the procedure.

SECTION 4

Coordinator to Propeller Rigging

The Section 1 checkout may have indicated misadjustment of the control system linkages between the coordinator and the propeller. Your first step in adjusting this part of the power plant rigging is to place the flight station condition lever of the engine to be adjusted in the RUN position. Move the throttle lever for this engine to the TAKEOFF position. Since you will need to change the throttle and condition lever settings several times during the various rigging steps, it is best to have an assistant remain in the flight station throughout the procedure to move the controls as required.

Next, examine the pointer on the coordinator protractor at the engine. It should indicate 90 degrees and be against the internal stop of the coordinator. If the pointer does not read 90 degrees, loosen the screws which hold the pointer and reposition it on the shaft so that 90 degrees is indicated when the shaft is turned against the coordinator's internal stop.

Now have your assistant in the flight station move the throttle lever to the FLIGHT IDLE position. Insert a

short 1/4-inch diameter rig pin in the rigging hole on the propeller control rear lever assembly. Check the reading at the coordinator protractor. The pointer should now indicate 34 degrees. If it does not, disconnect the propeller control rear link at the control lever and adjust the length of the rod so that the coordinator pointer reads 34 degrees.

Leave the rig pin in place and move on up to the bellcrank assembly mounted on the reduction gearbox. Try to insert another short 1/4-inch diameter rig pin into the hole provided in the bellcrank. If it will not fit properly, disconnect the propeller control intermediate link at the control lever and adjust the rod length so that the rig pin can be inserted easily.

Now remove all rig pins and, with the flight station lever still in the RUN position, have your assistant move the throttle lever slowly to TAKEOFF, then back to FLIGHT IDLE, and then to the MAXIMUM REVERSE position. Observe the movement of the propeller indexing lever with respect to the index bracket mounted on the back of the control valve assembly housing. The lever should line up under the proper slot at each of the throttle positions.

If the alignment appears to be good, attempt to insert the three-step alignment pin through the appropriate slot in the index bracket and into the hole in the indexing lever at each of the three throttle positions.

The alignment should be satisfactory at all throttle positions. If it is not, disconnect the propeller control forward link at the bellcrank clevis and adjust the linkage as follows:

If the total travel of the indexing lever appears to be displaced to the right or to the left with respect to the maximum reverse and takeoff slots in the index bracket, adjust the length of the propeller control forward link in order to center the indexing lever movement. Note that the thread on the bellcrank end of the forward link is left-handed on most aircraft.

If the throw of the lever appears to be too long or too short, adjust the length of the bellcrank clevis rod. Check the progress of your adjustments as you go by reconnecting the forward link to the clevis rod and observing the movement of the propeller indexing lever as your assistant moves the flight station throttle lever through its full range.

Continue adjusting both bellcrank clevis rod and propeller control forward link, if necessary, until the alignment pin will fit through the proper slots on the propeller index bracket when TAKEOFF, FLIGHT IDLE,

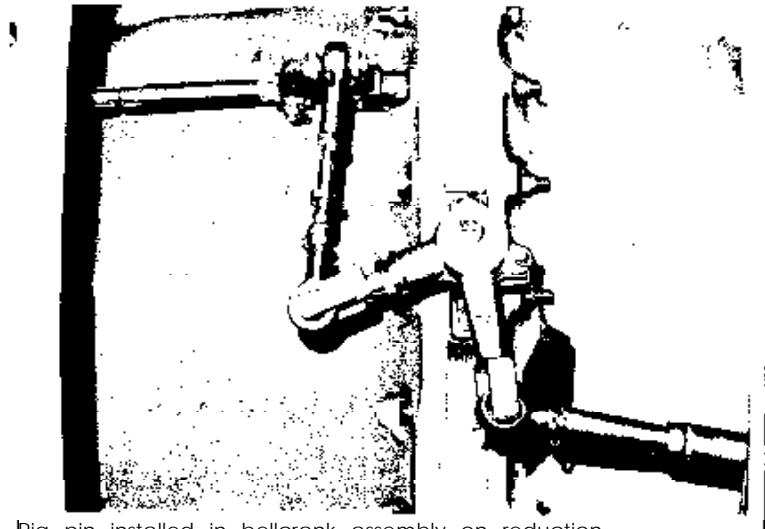

Rig pin installed in bellcrank assembly on reduction gearbox. Note (1) propeller control forward link; (2) bellcrank clevis rod.

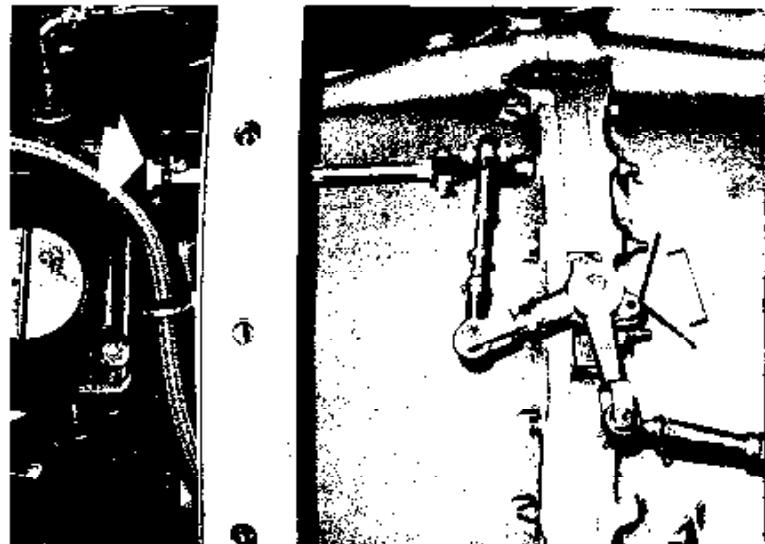

Bellcrank assembly and propeller indexing lever correctly aligned at flight idle.



Propeller indexing lever pinned at takeoff.

and **MAXIMUM REVERSE** are selected in the flight station. When these checks are satisfactory, tighten all self-locking nuts and jamnuts sufficiently so that they will not slip during subsequent steps of this procedure.

Before proceeding to the next adjustment, have the flight station throttle lever moved to **TAKEOFF**, **MAXIMUM REVERSE**, and then to **FLIGHT IDLE** while you observe the reading on the coordinator protractor at each throttle position. The pointer should read 90 degrees in **TAKEOFF**, 0 degrees in **MAXIMUM REVERSE**, and 34 degrees in **FLIGHT IDLE**.

Now have the condition lever moved to the **FEATHER** position. Return to the propeller index bracket and try to insert the three-step alignment pin through the feather slot and into the indexing lever.

If the alignment is not satisfactory, locate the condition control link on the inboard side of the coordinator which attaches the coordinator condition lever to the condition transfer clevis. Disconnect this rod at the clevis and adjust as follows: If the indexing lever tends to rotate past the feather slot of the index bracket, loosen a jamnut and turn the rod end 1/2 turn to shorten it; if the indexing lever does not rotate far enough, turn the rod end 1/2 turn to lengthen it.

When you have achieved a satisfactory adjustment of the feather position at the index bracket, reconnect the rod assembly to the condition transfer clevis and tighten the jamnut finger tight. Examine the witness holes in the rod assembly. They must be closed to ensure that a sufficient number of threads on the rod ends are engaged within the barrel.

Now check to make certain that the movement of the condition transfer clevis is limited by the external feather stop, and not the fuel cutoff stop lever. There should be a clearance of between 0.01 and 0.11 inches between the fuel cutoff stop lever and its stop pin. Adjust the micromatic screw if necessary to obtain this clearance. Be sure not to disturb the setting of the fuel cutoff stop lever. Its position with relation to the shaft should not be changed.

You are now ready to make a final check of the propeller-to-coordinator linkage system. Be sure that the alignment pin has been removed from the feather slot in the index bracket and have the condition lever returned to the **RUN** position. Have your assistant in the flight station move the throttle lever to **TAKEOFF**, then to **MAXIMUM REVERSE**, and finally **FLIGHT IDLE** while you check all adjustments by inserting the alignment pin through the index bracket and into the indexing lever at each position. When the throttle lever has been returned to **FLIGHT IDLE**, also confirm that a rig pin can still be inserted in the hole in the bellcrank assembly on the reduction gearbox.

If these checks are satisfactory, you can complete this part of the rigging procedure by torquing all nuts to the proper values and replacing safety wire as required.

SECTION 5

Coordinator to Fuel Control Rigging

If the linkages between the coordinator and the fuel control show evidence of being out of adjustment, proceed as follows: Place the condition lever of the engine to be checked in the **RUN** position, and the throttle lever in the **FLIGHT IDLE** position. You will need to move the throttle and condition levers several times as the various checks and adjustments are made, so it is



Propeller indexing lever pinned at maximum reverse.

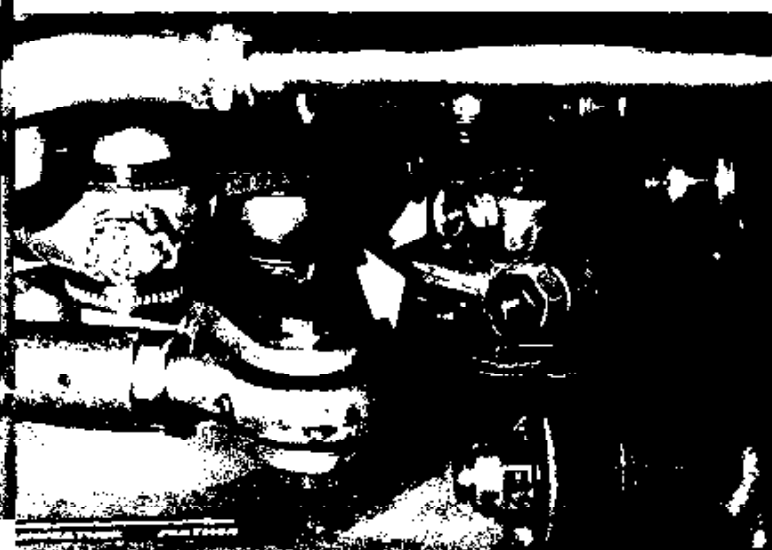

Fuel cutoff stop lever and stop pin.

a good idea to have an assistant remain in the flight station throughout the procedure to move the controls as necessary.

Now insert a short 1/4-inch diameter rig pin into the hole provided in the propeller control rear lever assembly, and then check to see that the protractor pointer on the outboard side of the coordinator reads 34 degrees. If it does not, first re-rig the engine according to the information given in Section 4, which deals with coordinator-to-propeller rigging.

If the protractor pointer does indicate the required 34 degrees, locate the condition control link on the inboard side of the coordinator that attaches the coordinator condition lever to the condition transfer clevis. Disconnect the rod assembly at the coordinator end and rotate the coordinator condition lever clockwise to full unfeather, as far as it will go.

Next, disconnect the rod assembly that attaches the throttle output lever of the coordinator to the fuel control throttle lever at the forward end. It will usually be necessary to remove the rig pin from the rear control lever assembly and have the throttle lever in the flight station moved to MAXIMUM REVERSE to make the rod end accessible.

Locate the protractor on the underside of the fuel control and move the fuel control pointer through its full range. Check the readings at the pointer. The readings at the ends of travel should be $0(\pm 1/2)$, and $90(\pm 1)$ degrees.

Now move the fuel control throttle lever so that the protractor pointer indicates 73.5 degrees. Note the position of the throttle lever with respect to the protractor scale. It should now be vertical, opposite the 45-degree mark. Use the position fixture, No. 6796658 or the equivalent, to verify the setting of the fuel control lever. If necessary, adjust the micromatic screw on the throttle lever at the shaft to obtain a reading of 45 degrees.

As the next step, set the length adjustment screw on the fuel control throttle lever at the center of its range. Check the rod assembly which attaches the fuel control throttle lever to the throttle output lever of the coordinator to see that the thread engagement at both ends is equal; the witness holes should be closed.

Reconnect the rod assembly to the fuel control throttle lever and have the flight station throttle lever returned to FLIGHT IDLE. Reinsert the rig pin in the propeller control rear lever assembly, and adjust the rod length so that the coordinator pointer and the pointer on the

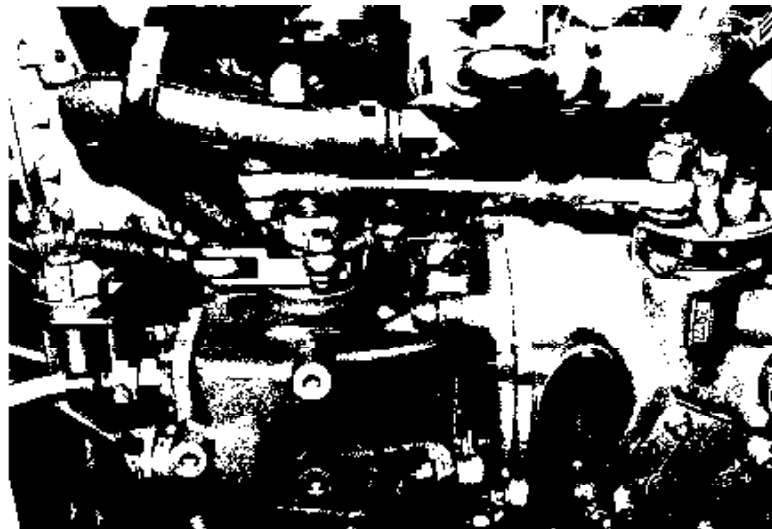

Disconnect indicated rod assemblies to make coordinator to fuel control rigging adjustments.

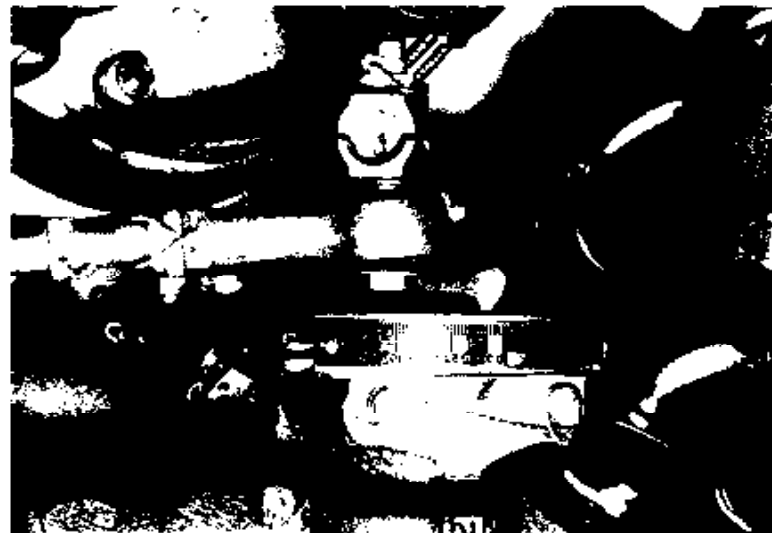

Fuel control protractor with indicator at 34 degrees.

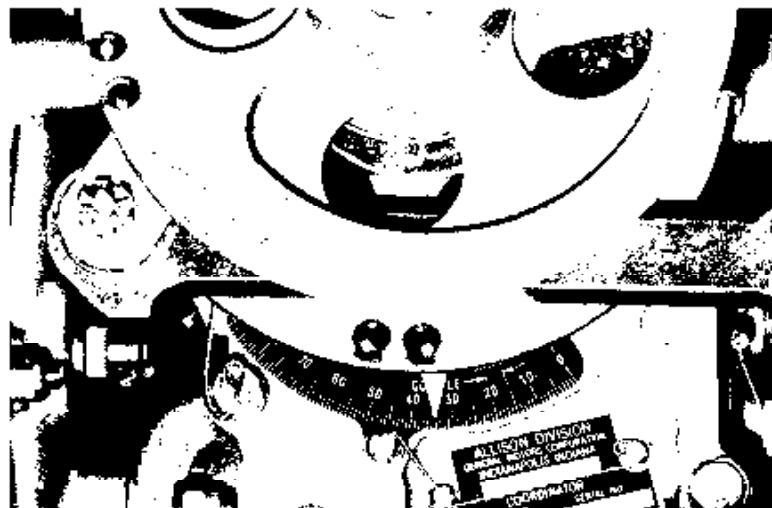

Engine control coordinator with indicator at 34 degrees. Identical values must always be shown on both protractors.

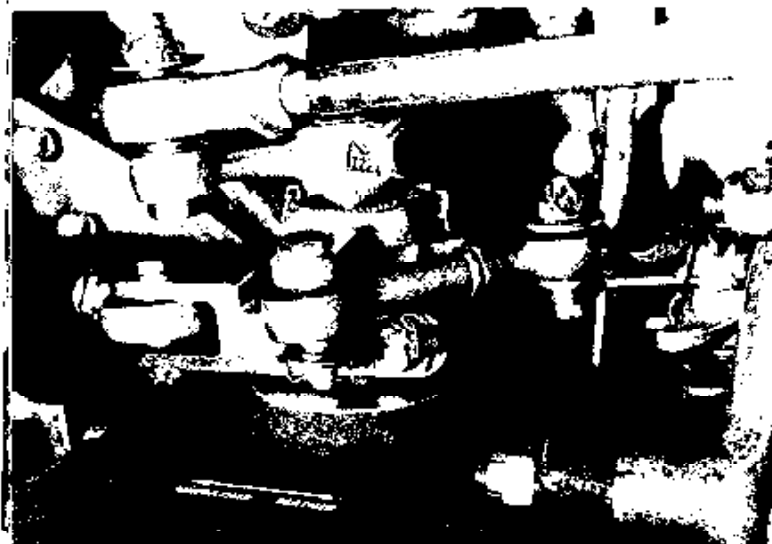

The fuel cutoff rod should measure 2 and 23/64 (± 1/64) inches between mounting hole centers.



Length adjusting screw on fuel control throttle lever.

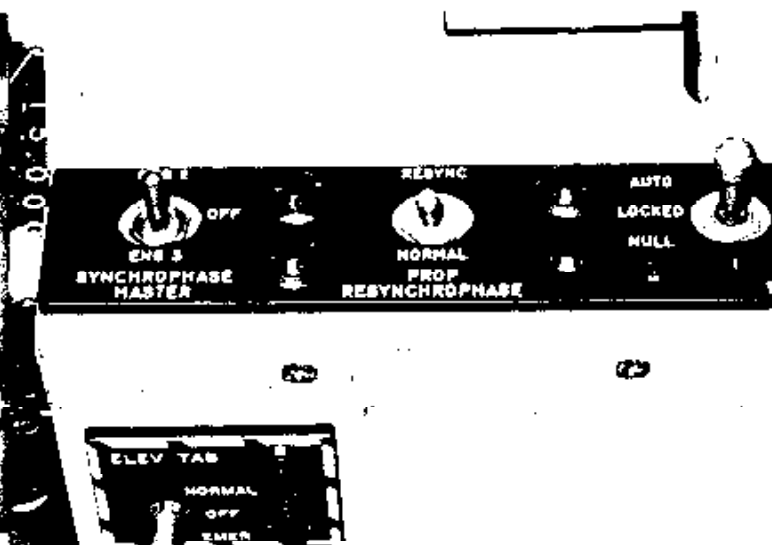

Do not operate the PROP RESYNCHROPHASE switch with the propellers static.

fuel control unit both indicate 34 degrees. The throttle output lever on the coordinator and the fuel control throttle lever should be parallel.

Now remove the rig pin from the propeller control rear assembly and have the throttle lever in the flight station moved through its full range from TAKEOFF to MAXIMUM REVERSE and back to the FLIGHT IDLE position. The readings at the fuel control unit protractor and the coordinator protractor should agree within 1 degree at all points.

If the readings do not agree, turn the length adjusting screw on the fuel control throttle lever to change the travel of the pointer on the fuel control unit. Adjust the screw inward to increase the travel of the pointer, and outward to decrease its travel. One-half turn will amount to a change of about a degree in the reading obtained.

Now reconnect the rod assembly which attaches the condition transfer clevis on the coordinator to the coordinator condition lever and have the condition lever in the flight station moved to the FEATHER position. The condition transfer clevis should be against the external feather stop.

Check to see that the fuel cutoff rod which extends from the coordinator to the fuel cutoff valve lever measures 2 and 23/64 (± 1/64) inches between mounting hole centers. Adjust the micromatic screw on the fuel cutoff lever to obtain a clearance of 0.01 to 0.11 inches between the stop lever on the fuel cutoff valve shaft and the stop pin. Be sure to make the adjustment by moving the fuel cutoff lever, not the stop lever itself.

Now tighten all control linkage 10-32 self-locking nuts to a torque value of between 30 and 40 inch-pounds. Tighten the fuel control cutoff lever and fuel control throttle lever micromatic screw 1/4-20 self-locking nuts to a value of between 80 and 85 inch-pounds. Tighten the coordinator condition lever, fuel control cutoff lever, and throttle output lever 1/4-28 self-locking nuts to a torque value of between 45 and 50 inch-pounds.

You can now complete this portion of the Hercules power plant rigging procedure by checking to see that all linkages have been installed and all jamnuts properly tightened. Have all linkages operated through their entire ranges from the flight station. If necessary, loosen the rod end jamnuts and rotate the rod ends to eliminate any interference which may be present. Note that rod ends should be replaced when movement of more than 0.005 inches perpendicular to the mounting hole of the rod end can be detected with the bearings in a stationary position.

Static Propeller Adjustments

The static propeller checks and adjustments described in this section should be carried out after installation of a replacement control valve housing, or after repairs have been performed on the propeller control valve assembly in which the internal settings may have been disturbed.

Please note that the procedures discussed in this section include selected propeller rigging steps which are particularly useful in connection with power plant rigging. They are static checks and do not constitute a complete operational checkout of the propeller. **Full propeller operational checks should be done in accordance with the instructions given in the appropriate technical publication.**

Three cautionary notes are applicable in connection with static propeller checks: First, be sure that the propeller control assembly has been serviced with the correct quantity and type of oil before attempting to cycle the propeller. Without oil, the pressure cutout switch cannot be activated to stop auxiliary pump operation at the feather position. Second, the temperature of the propeller oil must be at least 32 degrees F, or 0 degrees C, before any movement of the propeller blades should be attempted. Seal damage and leakage will occur if blade angle checks are carried out at temperatures below freezing. Finally, be sure not to operate the PROP RESYNCHROPHASE switch with the propellers static.

To carry out most static propeller adjustments, you will need a source of AC power to operate the feather pump of the propeller. Either an external power source or power from the internal ATM generator or APU may be used.

As the first step in this procedure, you will want to confirm that the input shaft assembly has been properly adjusted during the installation of the propeller control valve housing cover. This may be done before providing AC power to the airplane, if desired. Have the flight station condition lever placed in RUN, and the throttle lever in FLIGHT IDLE. Remove the access plate from the cover of the valve housing assembly, and locate the beta schedule rig pin hole in the control valve assembly.

Attempt to insert the three-step propeller alignment pin through the beta schedule rig pin hole and into the slot in the alpha shaft. If the pin fits properly, leave it installed and attempt to insert a second three-step alignment pin through the flight idle slot of the propeller index bracket into the indexing lever.

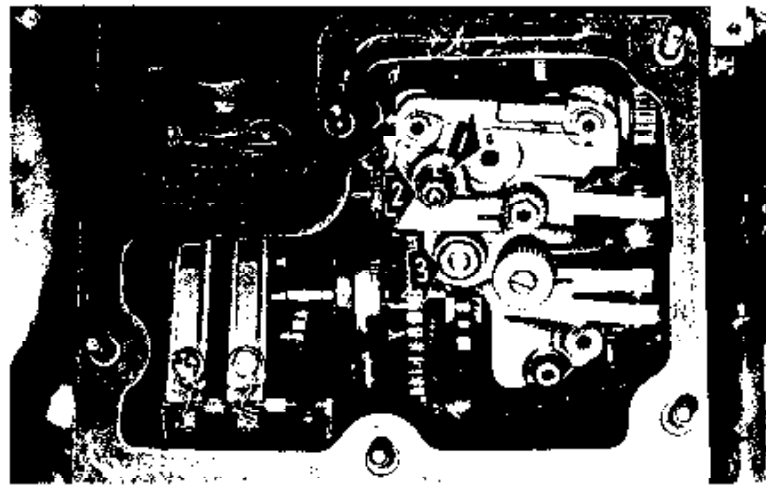

Propeller control valve assembly with access plate removed. Note (1) beta schedule rig pin hole; (2) reverse stop adjustment; (3) beta schedule adjusting nut.

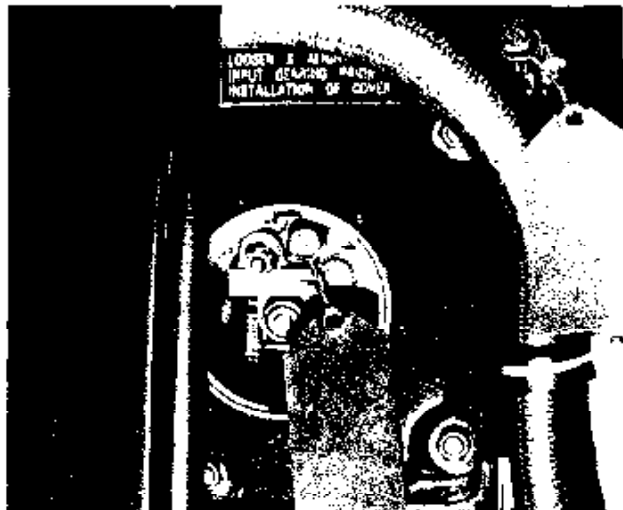

Alignment pins installed in beta schedule rig pin hole and propeller indexing lever. (Remove entire access plate to make adjustments.)

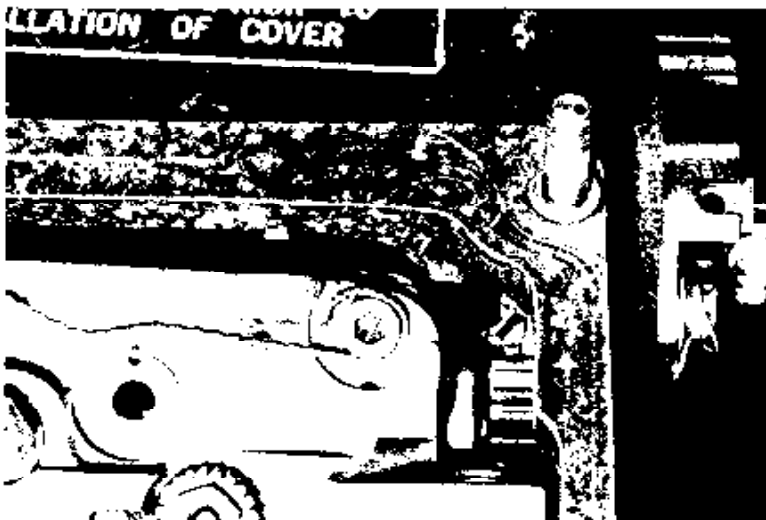

Note head of split gear preload adjusting screw accessible at maximum reverse.

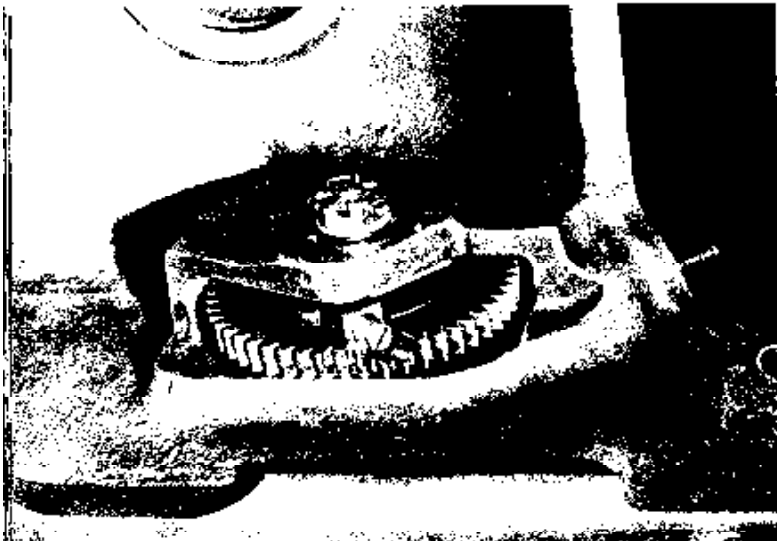

View of split gear inside propeller control valve housing cover.



Microrings for adjusting propeller indexing lever position.



Static propeller adjustments include checks of clearances at the NTS bracket.

If these checks are satisfactory, remove both pins and have the throttle lever in the flight station placed in the **MAXIMUM REVERSE** position. Now locate the preload screw on the split gear which is mounted on the input shaft just inside the cover of the valve housing assembly on most aircraft. The screw head should be accessible for screwdriver adjustment. Check also to see that only the double portion of the split gear is meshed with the spur gear on the end of the alpha shaft. The single segment is not strong enough to bear the required loads. *Damage will result if this segment of the gear is allowed to contact the input gear on the alpha shaft in any operating position.*

In the event that any of the checks of the input shaft assembly have proved unsatisfactory, it will be necessary to remove the cover of the valve housing assembly and readjust it. Disconnect the linkage to the coordinator at the universal joint just aft of the propeller index bracket, remove the nuts that hold the cover to the body of the valve housing assembly, and lift it off.

Loosen the nut on the aft end of the input shaft enough to free the micro adjusting rings. Adjust the position of the indexing lever so that it will be in the maximum reverse position when the preload screw on the split gear inside the cover is lined up parallel to the base of the cover.

The head of the screw must face toward the access plate in the cover of the valve housing so that it can be reached with a screwdriver after replacement of the cover. Adjust the screw at this point to remove any preload on the split gear. Now retighten the nut on the input shaft to close the microrings and lock the indexing lever in place on the shaft.

Next, rotate the alpha shaft of the control valve assembly so that a three-step alignment pin can be inserted through the beta schedule rig pin hole and into the upper slot on the cam on the alpha shaft. This is the flight idle position. Leave the pin in place and use a second three-step pin to also fix the indexing lever of the input shaft in the flight idle position.

Carefully lower the cover onto the valve assembly. It will be necessary to temporarily remove the alignment pin from the propeller indexing lever in order to get the teeth of the split gear and the alpha input gear to engage properly, but be sure that the pin will fit at the flight idle slot after the cover is fully in place. When the cover is seated, replace the nuts which hold the cover in place and reconnect the linkage to the coordinator.

Remove the alignment pins and have the throttle lever

in the flight station moved to the MAXIMUM REVERSE position. Check again to be sure that the double portion of the split gear is properly mated with the gear on the alpha shaft, and that the preload screw is accessible. Now tighten the preload screw sufficiently to remove any lash; then replace the access cover and tighten down the nuts.

Whenever the cover of the control valve housing has been removed, the clearance on the NTS bracket should be checked. Have an assistant rotate the control assembly firmly against the drive bracket in a counterclockwise direction, as viewed from the front. Check the clearance between the control lever on the valve housing assembly and its adjustment screw, and also the clearance between the engine NTS plunger and the engine lever adjusting screw. Both should be between 0.011 and 0.020 inches.

Next, with AC power on the airplane, close the following circuit breakers of the propeller and engine under test. On the copilot's side circuit breaker panel, close PROP OIL LEVEL, NTS CHECK, and FEATHER & AIR START. On the pilot's side circuit breaker panel, close FEATHER PROP MOTOR, PHASE A, B, and C.

Now place the FEATHER VALVE AND NTS CHECK switch in the flight station to the VALVE position, and move the condition lever to the FEATHER position. The FEATHER OVERRIDE button should pull in while the propeller blades are moving toward the feathered position, and the FEATHER VALVE AND NTS CHECK light should illuminate.

A maximum of 23 seconds will be required to bring the propeller to full feather when the engine oil temperature is within normal limits. The FEATHER VALVE AND NTS CHECK light may extinguish after the blades have stopped moving. Watch the FEATHER OVERRIDE button to be sure that it pops out when the propeller blades have reached the feathered position. If the button does not pop out within 5 seconds after the propeller feathers, pull it out manually to prevent damage to the propeller auxiliary pump. Note that the duty cycle for the auxiliary pump is equal time on and off, up to 60 seconds on and 60 seconds off. The maximum total running time is 2 minutes in any 30-minute period. You may run it longer providing you can hold your hand on it for 5 seconds or longer—approximately 150 degrees F—but monitor it closely.

Now place the FEATHER VALVE AND NTS CHECK switch to the NORMAL position and note

that the light should be extinguished. Next, place the switch to the NTS position, and note that the light should illuminate.

Move the condition lever of the engine under test from the FEATHER position to the GROUND STOP position and note that the NTS light should remain illuminated.

Now move the throttle lever to the FLIGHT IDLE position and hold the condition lever in the AIR START position until the propeller blades stop moving. The blades should move from the feather position to the low pitch stop position.

Next, insert a 0.225 inch shim between the NTS plunger on the reduction gearbox and the lever of the bracket and lever assembly. Place the FEATHER VALVE AND NTS CHECK switch to the VALVE position and hold the condition lever to the AIR START position. The FEATHER VALVE AND NTS CHECK light should illuminate, and the propeller blades should move toward the feather position. *Be careful not to move the throttle lever, and do not move the condition lever toward the FEATHER position while the shim is installed.* After this check is complete, remove the shim from the NTS bracket and return the NTS switch to the NORMAL position.

You are now ready to carry out a series of blade angle checks and adjustments at the propeller control valve housing. Before proceeding with any of the blade angle checks, however, determine whether the propeller in

Propeller controls on the copilot's side shelf.

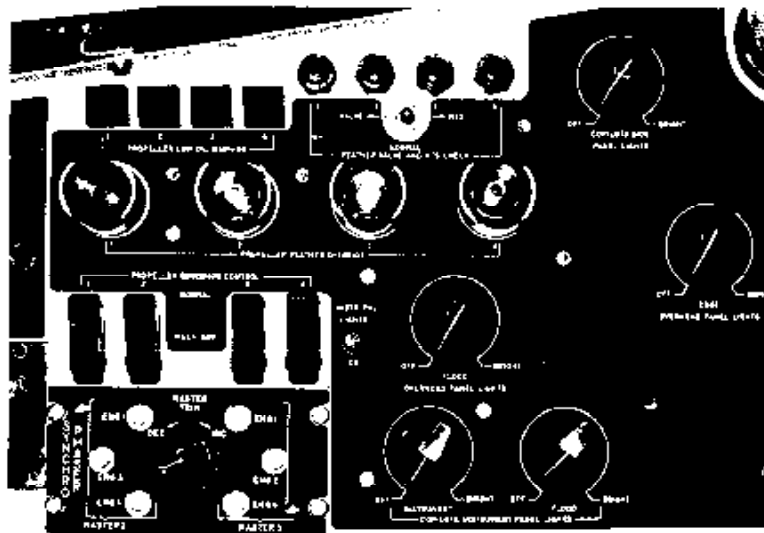

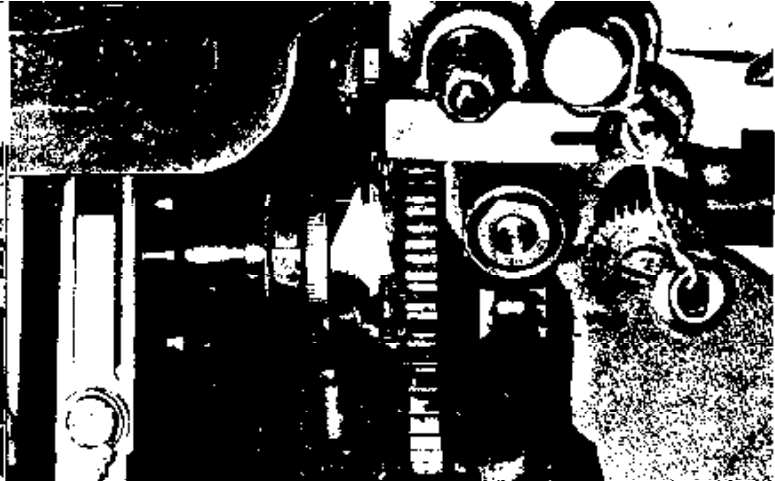

Backup valve control cam scale indicating a blade angle of 4.5 degrees.

question is equipped with a standard or a servo governor. Some of the beta schedule settings for propellers equipped with servo governors are slightly different from those equipped with the standard governors. Both values will be given where applicable. Note also that since the throttle and condition lever settings will need to be changed several times during this part of the procedure, it is best to have an assistant remain in the flight station to move the controls as required.

Have the condition lever in the flight station moved to the FEATHER position. Remove the access plate on the valve housing cover and locate the scale on the backup valve control cam. The scale should show an indicated blade angle of 92.5 degrees at the reference mark.

If the reading indicates that the beta shaft is not indexed correctly, write down the actual reading and proceed as follows: Have the throttle lever moved to the GROUND IDLE position and the condition lever to AIR START. This will rotate the beta shaft and allow access to the adjusting screws. When the blade movement stops, note the reading on the cam scale and, by using the adjustment screws, add or subtract a sufficient number of degrees so that the cam scale will read 92.5 degrees when the propeller is returned to the feather position. Check this by having your assistant place the condition lever in the FEATHER position. When the blades stop moving, the backup valve control scale should read 92.5 degrees.

You are now ready to carry out the beta schedule check. First, the condition lever should be returned to RUN, and the throttle lever to MAXIMUM REVERSE. Then have the condition lever held in AIR START until the blade movement ceases.

Have the throttle moved to GROUND IDLE and insert a No. 546456 two-step alignment pin through the beta schedule rig pin hole and into the slot on the alpha shaft cam. Now have the condition lever held in AIR START until the prop blades stop moving. Remove the alignment pin and check the reading

on the backup valve control cam scale for the correct indication of 4 to 5.5 degrees; if the propeller is equipped with a servo governor, the value should be 5 to 6.5 degrees.

If the reading is greater than the maximum allowable angle for the propeller you are testing, turn the beta schedule adjusting nut counterclockwise to decrease the blade angle. If the reading is less than the required minimum angle, turn the beta schedule adjusting nut clockwise to increase the blade angle. Each locking notch of the hexagonal locking sleeve is equal to about 1/2 degree of blade angle.

Whenever the beta schedule adjustment is changed, repeat the movement of the throttle lever to MAXIMUM REVERSE and back to GROUND IDLE, removing and reinstalling the two-step pin each time. At both throttle lever positions, have the condition lever held in AIR START until the propeller movement stops. Note that once the GROUND IDLE setting is correctly established, the rest of the schedule will be correct since the schedule is determined by the profile of the alpha and beta cam contours.

Now have the throttle lever moved to FLIGHT IDLE and fit a three-step alignment pin through the beta schedule rig pin hole and into the slot on the alpha shaft cam. Have the condition lever held in AIR START until the blades stop moving and then check the blade angle shown on the backup valve control cam. It must be at least 17.5 degrees for standard governors and 18.5 degrees for servo governors.

After beta shaft indexing and beta schedule adjustment have been carried out, remove the alignment pin and have the throttle set to MAXIMUM REVERSE, and the condition lever held in AIR START until blade movement stops. Check the reading on the backup valve cam scale for a reading of - 6 to - 8 degrees, the correct reverse stop setting for propellers with standard governors. Where the propeller is equipped with a servo governor, - 6.5 to - 8.5 degrees is the desired angle.

If the indicated blade angle is not correct, have the throttle lever returned to GROUND IDLE or above and reset the reverse stop adjustment located directly above the beta schedule adjusting nut. Turning the reverse stop two flats of the hexagon will produce about a one degree change in the propeller angle. Clockwise rotation reduces the negative angle, and counterclockwise rotation increases it.

When the reverse stop adjustment has been made, the static propeller checks and adjustments are complete. Replace the access plate on the cover of the propeller control valve housing, and tighten down the nuts. Be sure that all alignment pins and rigging pins have been removed from the linkages and from the inside of the control valve housing.

SERVICE BOWS

When aircraft landing wheels are inspected for evidence of damage and cracks during periodic inspections or tire changes, it is a good practice to make sure that each wheel assembly is given a really thorough check.

In July-September 1977 issue of *Service News* (Vol. 4, No. 3), we touched upon many of the general procedures which are applicable to aircraft tire and wheel maintenance. In the field, of course, it is often the details of just how a specific maintenance task is carried out that make all the difference.

An interesting case in point concerns wheel inspections. Goodyear Aerospace Corporation, a major manufacturer of aircraft wheels, warns in their *Service Letter* dated 1 June 1976 that there appears to be a tendency to overlook certain sections of the wheel halves during inspections. Operators generally examine the bead seat and tire sealing areas carefully, but may let a quick once-over suffice for other parts of the wheel assembly. Cracks and damage may lurk undetected in these areas, opening the door to leaks or sudden failure later on.

An important area which is frequently neglected is the outer surface of the tube well (see Figure 1). Small cracks in this part of the wheel may in time extend through to the inner surface and allow leakage to take place. The loss of air pressure will usually lead to the discovery of the problem while the crack is still rela-

tively small, but if the crack penetrates through a portion of the wheel that is covered by the bead, the tire will continue to hold air and the crack may remain undetected. In such cases it is possible for a crack to go unnoticed until it is large enough to endanger the structural integrity of the wheel.

The best way to avoid such a possibility is to put special emphasis on close examination of the critical area of the tubewell, as well as the bead seat. During inspections or disassembly of a wheel, take the time to examine each

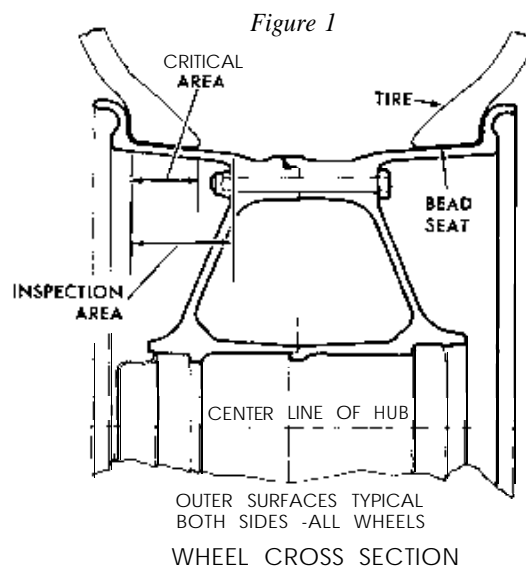

wheel half carefully. Check the surfaces of the tubewell area for cracks or potential cracks, and pay particular attention to the section from the bead radius to the end of the toe of the tire.

SAVING ROWS



Index by Subject ~ VOL.I, NO.1 through VOL.4, NO.4

ELECTRICAL AND ELECTRONICS

	Issue	Page
AC VOLTAGE REGULATORS Matching of Generator and Voltage Regulator	VOL. 4, NO. 4 OCT-DEC '77	16
APQ-122 RADAR Basic Description and Operation	VOL. 4, NO. 4 OCT-DEC '77	3
BOOST PUMP ELECTRICAL CONNECTOR For the Hydraulic Suction Boost Pump	VOL. 4, NO. 4 OCT-DEC '77	18
CONNECTORS Part Number Cross-Reference and Important Details on Assembly (Fuel Quantity Indicating System)	VOL. 1, NO. 3 JUL-SEP '74	16
HERCULES WIRE IDENTIFICATION Including a Cross-Reference Chart	VOL. 1, NO. 2 APR-JUNE '74	9
NICAD (NICKEL-CADMIUM) BATTERIES Don't leave "Well Enough" Alone	VOL. 1, NO. 4 OCT-DEC '74	10

ENGINES AND PROPELLERS

CRACKED PROPELLER DOME SHELL	VOL. 3, NO. 2 APR-JUN '76	14
HERCULES ENGINE TACHOMETER SYSTEM	VOL. 1, NO. 1 JAN-MAR '74	8
HERCULES PROPELLER CONTROL OIL LEVEL CHECK Using the Atmospheric Sump Dipstick	VOL. 1, NO. 2 APR-JUN '74	3
OIL PRESSURE TRANSMITTER VENT LINE ON JETSTAR ENGINES	VOL. 4, NO. 1 JAN-MAR '77	22
PRESERVATION OF T-56 ENGINES	VOL. 2, NO. 4 OCT-DEC '75	9
PROPELLER VALVE HOUSING INSTALLATION	VOL. 2, NO. 2 APR-JUN '75	19
STARTING FOR A LONGER ENGINE LIFE Understanding Engine Starting Events	VOL. 2, NO. 2 APR-JUN '75	3
THE EXTERNAL SCAVENGE OIL FILTER Checklist for Oil Venting and Differential Pressure Symptoms	VOL. 2, NO. 2 APR-JUN '75	7
TROUBLESHOOTING ENGINE START PROBLEMS	VOL. 4, NO. 1 JAN-MAR '77	23
TURBINE TEMPERATURE TROUBLESHOOTING How to Check Abnormal Temperature Readings from One Engine Against the Other Three	VOL. 1, NO. 4 OCT-DEC '74	3
USING THE TACH GENERATOR TEST FOR AN AUTO-TAC	VOL. 4, NO. 3 JUL-SEP '77	17
WHERE DID THE OIL GO? Troubleshooting Engine Oil Losses- Replacement of An Accessory Housing Oil Seal	VOL. 2, NO. 3 JUL-SEP '75	14

FUEL SYSTEM

	Issue	Page
AN UPCOMING PRODUCT IMPROVEMENT New Fuel Quantity Tank Probes	VOL. 4, NO. 1 OCT-DEC '76	22
A QUICK WAY TO DRAIN HERCULES AUX TANKS	VOL. 1, NO. 2 APR-JUN '74	6
CONNECTORS Part Number Cross-Reference and Important Details on Assembly	VOL. 1, NO. 3 JUL-SEP '74	16
CONTROLLING MICROBIAL GROWTH In Aircraft Fuel Tanks	VOL. 2, NO. 2 APR-JUN '75	10
DELAYED MAINTENANCE.. . CAN GIVE YOU A BLAST Fuel Quantity Indicating System Operation	VOL. 1, NO. 3 JUL-SEP '74	18
HERCULES FUEL QUANTITY INDICATING SYSTEM	VOL. 1, NO. 3 JUL-SEP '74	2
HERCULES FUEL VENT SYSTEM Keep Obstructions Out	VOL. 1, NO. 1 JAN-MAR '74	14
LEAKY FASTENERS Prevention and Detection of Leaking Fuel Tank Fasteners	VOL. 4, NO. 2 APR-JUN '77	3
LOCATING LEAKS In Auxiliary Fuel Tanks By Color	VOL. 2, NO. 2 APR-JUN '75	14
REPAIR OF RUBBER COVERING ON INFLIGHT REFUELING HOSES	VOL. 4, NO. 2 APR-JUN '77	15

GENERAL AIRFRAME		
	VOL. 4, NO. 1 JAN-MAR '77	3
	VOL. 4, NO. 3 JUL-SEP '77	17
	VOL. 2, NO. 4 OCT-DEC '75	15
DOORS	VOL. 3, NO. 3 JUL-SEP '76	14
FLIGHT CONTROL CABLE TENSION REGULATORS Description and Operation of Cable Tension Regulators	VOL. 2, NO. 1 JAN-MAR '75	13
HERCULES CREW ENTRANCE DOOR OPEN WARNING SWITCH ADJUSTMENT	VOL. 4, NO. 1 JAN-MAR '77	18
HERCULES FLAP SYSTEM A Brief Description of the Hercules Flap System	VOL. 4, NO. 3 JUL-SEP '77	22
HERCULES TOWBAR SHEAR BOLTS Explanation of Shear Bolt Function	VOL. 4, NO. 2 APR-JUN '77	14
INSTALLATION TOOL-WING LEADING EDGE HINGE PIN	VOL. 2, NO. 3 JUL-SEP '75	3
NUTS, BOLTS, SCREWS	VOL. 4, NO. 3 JUL-SEP '77	20
PRECIPITATION STATIC DISSIPATION Causes and Solutions for Precipitation Static		

GENERAL AIRFRAME (Cont d)

	Issue	Page
PREFORMED PACKINGS	VOL. 3, NO. 1 JAN-MAR '76	3
STATIC GROUND ASSEMBLIES Deleted from landing Gear	VOL. 4, NO. 3 JUL-SEP '77	21
TORQ-SET SCREWS AND TOOLS Descriptions, Illustrations, and Lists of Various Torq-Set Fasteners and Tools	VOL. 3, NO. 4 OCT-DEC '76	11
TURNBUCKLE TOOLS	VOL. 1, NO. 4 OCT-DEC '74	5
UPPER COWLING HINGE LUBRICATION Installing Grease Fittings to Lubricate Engine Cowling Hinge Pins	VOL. 4, NO. 4 OCT-DEC '77	15
WINDSHIELD WIPER ALIGNMENT TOOL	VOL. 1, NO. 4 OCT-DEC '74	9
WASHING THE HERCULES Emphasis Placed on the Value of Thorough Cleaning for Extended Service Life of an Airplane	VOL. 2, NO. 4 OCT-DEC '75	3

GROUND OPERATIONS

FLIGHT LINE OBSTACLE COURSE Caution During Taxiing or Towing	VOL. 2, NO. 1 JAN-MAR '75	3
HERCULES GROUND HANDLING Tips on Towing, Parking, Mooring, and Jacking the Hercules	VOL. 3, NO. 3 JUL-SEP '76	3
HERCULES TOWBAR SHEAR BOLTS Explanation of Shear Bolt Function	VOL. 4, NO. 3 JUL-SEP '77	22
HOT BRAKES Problems of Overheated Brakes	VOL. 4, NO. 3 JUL-SEP '77	18
HOW TO MOVE AN INCOMPLETE HERCULES Balance, Counterbalance and Removable Load Bearing Components Taken in Consideration	VOL. 2, NO. 1 JAN-MAR '75	4
OXYGEN SAFETY An Article Applicable to any Aircraft with an Oxygen System	VOL. 1, NO. 1 JAN-MAR '74	10
POLYTETRAFLUOROETHYLENE (TEFLON) Lining for Oxygen Servicing Hoses	VOL. 2, NO. 1 JAN-MAR '75	9

HYDRAULICS

BOOST PUMP ELECTRICAL CONNECTOR	VOL. 4, NO. 4 OCT-DEC '77	18
DONT SLAM THE DOOR Operating Tips for the Aft Cargo Door	VOL. 4, NO. 1 JAN-MAR '77	17
FLARELESS FITTINGS Treated Properly, a Better Fitting	VOL. 1, NO. 1 JAN-MAR '74	3
HERCULES FLAP SYSTEM A Brief Description of the Hercules Flap System	VOL. 4, NO. 1 JAN-MAR '77	18

HYDRAULICS (Cont d)

	Issue	Page
HOW TO BLEED A HERCULES HYDRAULIC PUMP-AND KEEP IT CLEAN	VOL. 1, NO. 2 APR-JUN '74	11
HYDRAULIC FLUID INTERCHANGE BETWEEN SYSTEMS A Leaking Accumulator Can Cause an Interchange of Hydraulic Fluid	VOL. 3, NO. 3 JUL-SEP '76	16
HYDRAULICS Hercules Hydraulic System Interconnect Valve Positioning Procedure	VOL. 2, NO. 4 OCT-DEC '75	10
NEW CHECK VALVE Specified for Hercules Hydraulic Pump Pressure Lines	VOL. 4, NO. 2 APR-JUN '77	15
NEW FILTER ELEMENTS For Hercules Hydraulic Systems	VOL. 2, NO. 1 JAN-MAR '75	14
NEW HYDRAULIC PUMP Limits Temperature	VOL. 2, NO. 3 JUL-SEP '75	12
OPENING THE HERCULES RAMP Using the Auxiliary System Handpump	VOL. 1, NO. 4 OCT-DEC '74	6
PRESSURE INDICATOR LAG	VOL. 2, NO. 4 OCT-DEC '75	12
SEALS FOR HERCULES PURULATOR HYDRAULIC FILTERS A Chart Listing the Seals Required to Service Hydraulic Filters	VOL. 3, NO. 3 JUL-SEP '76	13
SERVICING HERCULES HYDRAULIC FILTERS Seals for Servicing Hercules Hydraulic Filters	VOL. 3, NO. 1 JAN-MAR '76	15
TWO DIFFERENT HERCULES ENGINE DRIVEN HYDRAULIC PUMPS	VOL. 1, NO. 3 JUL-SEP '74	15

LANDING GEAR

HERCULES HIGH ENERGY BRAKES Single Disk Versus Multi-Disk	VOL. 2, NO. 1 JAN-MAR '75	10
HERCULES MLG BALLSCREW LUBE Side Lubrication Fitting Modified	VOL. 4, NO. 4 OCT-DEC '77	17
HOT BRAKES Problems of Overheated Brakes	VOL. 4, NO. 3 JUL-SEP '77	18
JETSTAR NOSE STEERING SYSTEM	VOL. 1, NO. 1 JAN-MAR '74	8
KEEP UP THE PRESSURE IN JETSTAR TIRES Precautions and Recommendations for Inflating JetStar Tires	VOL. 3, NO. 2 APR-JUN '76	15
NEW ALLOY For JetStar Landing Gear Shock Struts	VOL. 2, NO. 1 JAN-MAR '75	12
NOSE WHEEL SHIMMY And What to do About It	VOL. 3, NO. 1 JAN-MAR '76	18
SAFETY WIRE FOR HERCULES MLG Torque Tube Yoke Assembly	VOL. 3, NO. 4 OCT-DEC '76	15

LANDING GEAR (Cont'd)

	Issue	Page
STATIC GROUND ASSEMBLIES Deleted from landing Gear	VOL. 4, NO. 3 JUL-SEP 77	21
STEEL CYLINDERS FOR THE JETSTAR MLG ACTUATORS You Can Install These Preferred Spares	VOL. 1, NO. 2 APR-JUN 74	12
THINNER SERRATED PLATES For Hercules Main landing Gear	VOL. 4, NO. 3 JUL-SEP 77	21
TIRES Operation, Maintenance, and Handling Tips	VOL. 4, NO. 3 JUL-SEP 77	3

MISCELLANEOUS

FIRST FLIGHT OF MODIFIED JETSTAR	VOL. 2, NO. 2 APR-JUN 75	23
JETSTAR II Advanced Data On New Configuration	VOL. 2, NO. 2 APR-JUN 75	20
KC-130R FLIGHT SIMULATOR A Brief Description of the KC-130R Flight Simulator	VOL. 4, NO. 4 OCT-DEC 77	19
LOCKHEED AIRCRAFT SERIAL NUMBERS Identifies Production Sequence Only	VOL. 2, NO. 2 APR-JUN 75	19
THE STANDARDIZED LOGISTICS MANAGEMENT SYSTEM A Better Way to Maintain Any High Technology Product	VOL. 1, NO. 2 APR-JUN 74	7

PNEUMATICS AND ENVIRONMENTAL

	Issue	Page
FIRST AID FOR THE HERCULES TEMPERATURE CONTROL SYSTEM	VOL. 3, NO. 3 JUL-SEP 76	23
HERCULES AIR CONDITIONING A Basic Description of the Hercules Air Conditioning System	VOL. 3, NO. 2 APR-JUN 76	2
HERCULES NEW AIR CONDITIONING UNITS New Changes to the Hercules Air Conditioning System	VOL. 3, NO. 3 JUL-SEP 76	18
HERKYS NEW APU Operation and Description of the New APU for the Hercules	VOL. 3, NO. 4 OCT-DEC 76	3
HOW THE 1867TH FCS LICKED A TURBINE PROBLEM	VOL. 1, NO. 3 JUL-SEP 74	23
HOW JETSTARS KEEP THEIR COOL Maintenance of Turbine-Fan, Air Conditioning Refrigeration Units	VOL. 1, NO. 3 JUL-SEP 74	20
OXYGEN SAFETY An Article Applicable to any Aircraft with an Oxygen System	VOL. 1, NO. 1 JAN-MAR 74	10
POLYTETRAFLUOROETHYLENE (TEFLON) lining for Oxygen Servicing Hoses	VOL. 2, NO. 1 JAN-MAR 75	9
SPARE NUTS FOR V-BAND COUPLINGS Size and Part Number Designations for V-Band Coupling Nuts	VOL. 4, NO. 4 OCT-DEC 77	18
STARTER SERVICING	VOL. 3, NO. 4 OCT-DEC 76	11
THE FORGOTTEN SCREENS Cleaning Screens in the Air Conditioning System	VOL. 2, NO. 4 OCT-DEC 75	14

 **SERVICE NEWS**

CORRECTIONS:

The Vol. 4, No. 3, July-September 1977 issue of the *Service News* carried an article on page 21 entitled "Static Ground Assemblies Deleted From Landing Gear." The article stated that "MLG static grounding assemblies have been deleted from the JetStar, C-SA, C-141, and L-1011 aircraft with no reported problems to date." Although this statement is true for the C-5A, C-141, and L-1011, the static ground assembly has **not** been deleted from the JetStar and is still installed as part of the production aircraft.

Vol. 4, No. 4, October-December 1977. The illustration on page 5, entitled "Components and Location,"

has the nomenclature reversed on the navigator's indicator and the pilot's indicator. The illustration is correct; the titles should be switched.

Vol. 4, No. 4, October-December 1977. The article on page 18, entitled "Spare Nuts For V-Band Couplings" contains part numbers for size 10-32 and 1/4-28 nuts. The part number for the 10-32 nut is listed incorrectly as A1200J-02. The correct number is Z1200J-02.

 **SERVICE NEWS**

service news

ISSN 0014-1801 (Magazine)

VOL. 1, NO. 1, JANUARY-MARCH 1974

- 3 FLARELESS FITTINGS
Treated Properly a Better Fitting
- STARTIPS
- 8 Hercules Engine Tachometer System
- 9 JetStar Nose Steering System
- 10 OXYGEN SAFETY
An Article Applicable to any Aircraft with an Oxygen System
- 14 HERCULES FUEL VENT SYSTEM
Keep Obstructions Out

service news

VOL. 1, NO. 2, APRIL-JUNE 1974

- 3 HERCULES PROPELLER CONTROL OIL LEVEL CHECK
Using the Atmospheric Sump Dipstick
- 7 THE STANDARDIZED LOGISTICS MANAGEMENT SYSTEM
A Better Way to Maintain Any High Technology Product
- 9 HERCULES WIRE IDENTIFICATION
Including a Cross-Reference Chart
- 12 STEEL CYLINDERS FOR THE JETSTAR MLG ACTUATORS
You Can Install These Preferred Spares
- STARTIPS
- 6 A Quick Way to Drain Hercules Aux Tanks
- 11 How to Bleed A Hercules Hydraulic Pump – and Keep It Clean

service news

VOL. 1, NO. 3, JULY-SEPTEMBER 1974

- HERCULES FUEL QUANTITY INDICATING SYSTEM
- 2 TROUBLESHOOTING
- 6 Tank Units – Part Numbers and Capacitance
- 10 Troubleshooting Chart
- 15 Fuel Weight To Capacitance
- 16 CONNECTORS
Part Number Cross-Reference and Important Details on Assembly
- 18 DELAYED MAINTENANCE . . . CAN GIVE YOU A BLAST
- 20 HOW JETSTARS KEEP THEIR COOL
Maintenance of Turbine-Fan, Air Conditioning Refrigeration Units
- STARTIPS
- 15 Two Different Hercules Engine Driven Hydraulic Pumps
- 23 How the 1867th FCS Licked a Turbine Problem

service news

VOL. 1, NO. 4, OCTOBER-DECEMBER 1974

- 3 TURBINE TEMPERATURE TROUBLESHOOTING
How to Check Abnormal Temperature Readings from One Engine Against the Other Three
- 6 OPENING THE HERCULES RAMP
Using The Auxiliary System Handpump
- 10 NICAD (NICKEL-CADMIUM) BATTERIES
Don't Leave "Well Enough" Alone
- 15 CORRECTION
How JetStars Keep Their Cool
- STARTIPS
- 5 Turnbuckle Tools
- 9 Windshield Wiper Alignment Tool

INDEX

1974

THROUGH

1975

service news

VOL. 2, NO. 1, JANUARY-MARCH 1975

- 3 FLIGHT LINE OBSTACLE COURSE
Caution During Taxiing or Towing
- 4 HOW TO MOVE AN INCOMPLETE HERCULES
Balance, Counterbalance, and Removable Load Bearing Components Taken into Consideration
- 9 POLYTETRAFLUOROETHYLENE (TEFLON)
Lining for Oxygen Servicing Hoses
- 10 HERCULES HIGH ENERGY BRAKES
Single Disk Versus Multi-Disk
- 12 NEW ALLOY
For JetStar Landing Gear Shock Struts
- 14 NEW FILTER ELEMENTS
For Hercules Hydraulic Systems
- 13 STARTIPS
Hercules Crew Entrance DOOR OPEN Warning Light Switch Adjustment

service news

VOL. 2, NO. 2, APRIL-JUNE 1975

- 3 STARTING FOR A LONGER ENGINE LIFE
Understanding Engine Starting Events for a Professional Approach Toward Extending Engine Life
- 7 THE EXTERNAL SCAVENGE OIL FILTER
Extends Service Life of Hercules Power Plant – Checklist for Oil Venting and Differential Pressure Symptoms
- 10 CONTROLLING MICROBIAL GROWTH
In Aircraft Fuel Tanks
- 14 LOCATING LEAKS
In Auxiliary Fuel Tanks By Color
- 19 LOCKHEED AIRCRAFT SERIAL NUMBERS
Identifies Production Sequence Only
- 20 JETSTAR II
Advanced Data On New Configuration
- 23 FIRST FLIGHT OF MODIFIED JETSTAR
- STARTIP
- 19 Propeller Valve Housing Installation

service news

VOL. 2, NO. 3, JULY-SEPTEMBER 1975

- 3 NUTS, BOLTS, SCREWS
- 7 Bolt Identification Chart
- 8 Screw Identification Chart
- 9 Nut Identification Chart
- 12 NEW HYDRAULIC PUMP
Limits Temperature
- 14 WHERE DID THE OIL GO?
Troubleshooting Engine Oil Losses – Replacement of An Accessory Housing Oil Seal

service news

VOL. 2, NO. 4, OCTOBER-DECEMBER 1975

- 3 WASHING THE HERCULES
Emphasis Placed on The Value of Thorough Cleaning for Extended Service Life of an Airplane
- HYDRAULICS
- 10 Hercules Hydraulic System Interconnect Valve Positioning Procedure
- 12 Pressure Indicator Lag
- 15 DELAMINATION OF WHEEL WELL DOORS
- STARTIPS
- 9 Preservation of T-56 Engines
- 14 The Forgotten Screens



SERVICE NEWS

VOL. 3, NO. 1, JANUARY-MARCH 1976

- 3 PREFORMED PACKINGS
- 14 SEALS BY GREENE, TWEED & COMPANY
G-T Ring Chart
- 15 SERVICING HERCULES HYDRAULIC FILTERS
Seals for Servicing Hercules Hydraulic Filters
- 17 CARE AND HANDLING OF PREFORMED PACKINGS
- 18 NOSE WHEEL SHIMMY
And What to do About It
- 20 INDEX 1974 THROUGH 1975

SERVICE NEWS

VOL. 3, NO. 2, APRIL-JUNE 1976

- 2 HERCULES AIR CONDITIONING
A Basic Description of the Hercules' Air Conditioning System
Troubleshooting the System
- 12 KEEP UP THE PRESSURE IN JETSTAR TIRES
Precautions and Recommendations for Inflating JetStar Tires
- 14 STARTIP
Cracked Propeller Dome Shell

Hercules Air Conditioning

SERVICE NEWS

VOL. 3, NO. 3, JULY-SEPTEMBER 1976

- 3 HERCULES GROUND HANDLING
Tips on Towing, Parking, Mooring, and Jacking the Hercules
- 13 SEALS FOR HERCULES PUROLATOR HYDRAULIC FILTERS
A Chart Listing the Seals Required to Service Hydraulic Filters
- 14 FLIGHT CONTROL CABLE TENSION REGULATORS
Description and Operation of Cable Tension Regulators
- 16 HYDRAULIC FLUID INTERCHANGE BETWEEN SYSTEMS
A Leaking Accumulator Can Cause an Interchange of Hydraulic Fluid
- 18 HERCULES NEW AIR CONDITIONING UNITS
New Changes to the Hercules' Air Conditioning System
- STARTIP
First Aid for the Hercules Temperature Control System

*Ground Handling
New Air Conditioning Units*

SERVICE NEWS

VOL. 3, NO. 4, OCTOBER-DECEMBER 1976

- 3 HERKY'S NEW APU
Operation and Description of the New APU for the Hercules
- 11 TORQ-SET SCREWS AND TOOLS
Descriptions, Illustrations, and Lists of Various Torq-Set Fasteners and Tools
- STARTIPS
Starter Servicing
Safety Wire for Hercules
MLG Torque Tube Yoke Assembly

Hercules Gets New APU

INDEX

1976

THROUGH

1977

SERVICE NEWS

VOL. 4, NO. 1, JANUARY-MARCH 1977

- 3 CARGO RAMP RIGGING
System Requirements
Ramp Hook Test
- 18 HERCULES FLAP SYSTEM
A Brief Description of the Hercules Flap System
- 22 AN UPCOMING PRODUCT IMPROVEMENT
New Fuel Quantity Tank Probes
- 23 TROUBLESHOOTING ENGINE START PROBLEMS
Same Engine Starting Tips
- STARTIPS
Don't Slam the Door
Oil Pressure Transmitter Vent Line on JetStar Engines

Cargo Ramp Rigging

SERVICE NEWS

VOL. 4, NO. 2, APRIL-JUNE 1977

- 3 LEAKY FASTENERS
Description of Fastener Systems
Chart—History of Fasteners Used in Hercules Integral Wing Tanks
Leak Detection and Repair
- 15 REPAIR OF RUBBER COVERING ON INFLIGHT REFUELING HOSES
Procedures and Materials to Repair the Rubber Covering on Refueling Hose Assemblies
- 15 NEW CHECK VALVE
Specified for Hercules Hydraulic Pump Pressure Lines
- STARTIPS
Installation Tool—Wing Leading Edge Hinge Pin

SERVICE NEWS

VOL. 4, NO. 3, JULY-SEPTEMBER 1977

- 3 TIRES
Construction
Operating and Handling Tips
Inspections
Maintenance
Summary
- 17 CREW ENTRANCE DOOR CABLE
Adding a Support Cable to the Crew Entrance Door
- 18 HOT BRAKES
Problems of Overheated Brakes
- 20 PRECIPITATION STATIC DISSIPATION
Causes and Solutions for Precipitation Static
- 21 THINNER SERRATED PLATES
for Hercules Main Landing Gear
- 21 STATIC GROUND ASSEMBLIES
Deleted from Landing Gear
- 22 HERCULES TOWBAR SHEAR BOLTS
Explanation of Shear Bolt Function
- STARTIP
Using the Tach Generator Tester for an Auto-Tac

SERVICE NEWS

VOL. 4, NO. 4, OCTOBER-DECEMBER 1977

- 3 APQ-122 RADAR
System Operation
Subsystems
Glossary
- 15 UPPER COWLING HINGE LUBRICATION
Installing Grease Fittings to Lubricate Cowling Hinge Pins
- 16 AC VOLTAGE REGULATORS
Matching of Generator and Voltage Regulator
- 17 HERCULES MLG BALLSCREW LUBE
Side Lubrication Fitting Modified
- 18 SPARE NUTS FOR V-BAND COUPLINGS
Size and Part Number Designations for V-Band Coupling Nuts
- 19 KC-130R FLIGHT SIMULATOR
A Brief Description of the KC-130R Flight Simulator
- STARTIP
Boost Pump Electrical Connector

APQ-122 Radar