



Lockheed Martin Aeronautics Company
Supplier Tooling Manual
(Tool Manufacturing Specification - Material Control - 015)
TMS-MC-015

Applicable to
FORT WORTH – MARIETTA - PALMDALE
Sites to the extent specified herein

REVISION 23

CONTROLLED AND APPROVED BY:

Lockheed Martin Aeronautics Company
Procurement Quality Assurance

January 2008

IMPORTANT NOTICE: A hard copy of this document may not be the document currently in effect. The current version is ALWAYS the version on the LOCKHEED MARTIN network.

* REVISED

** ADDED

TABLE OF CONTENTS

PART I. AIRCRAFT ITEMS AND TOOLING - SELLER REQUIREMENTS

1.0	GENERAL	Page	5
2.0	TOOLING DEFINITIONS	Page	5
3.0	INTERCHANGEABLE-REPLACEABLE (I/R)	Page	7
4.0	"TO MATCH" HOLE PATTERNS AND OTHER I/R FEATURES	Page	7
5.0	CONTROL OF RECORDS	Page	8
6.0	CERTIFIED PROPERTY LIST (CPL-11300)	Page	9
7.0	CONTROL OF BUYER-FURNISHED TOOLS	Page	9
8.0	TOOL QUALITY CODE CATEGORIES	Page	10
9.0	TOOL PROTECTION AND STORAGE REQUIREMENTS	Page	11
10.0	SHIPPING INSTRUCTIONS	Page	11
11.0	TOOLING PERIODIC INSPECTION AND RE-VERIFICATION (PI/V) PROGRAM	Page	12
12.0	TOOLING PERIODIC INSPECTION AND RE-VERIFICATION (PI/V) RECORDS	Page	14

PART II. MANUFACTURED SPECIAL TOOLING ONLY – SELLER REQUIREMENTS

1.0	GENERAL	Page	14
2.0	DEFINITIONS – "REDLINE TOOL DESIGNS"	Page	14
3.0	SPECIAL TOOLING INSPECTION AND QUALITY REQUIREMENTS	Page	14
4.0	TOOL IDENTIFICATION	Page	15
5.0	PROCESS FOR TRANSFER OF TOOL DESIGNS FROM SELLER TO BUYER	Page	15
6.0	SEALING CRITICAL LOCATORS	Page	16

TABLE OF CONTENTS (cont'd.)

PART III. INTERNATIONAL SELLER REQUIREMENTS

1.0	GENERAL	Page	16
2.0	CONTROL OF SUPPORT EQUIPMENT (SE), MANUFACTURING TEST EQUIPMENT (MTE) AND SPECIAL TEST EQUIPMENT (STE)	Page	16
3.0	CHANGE AUTHORIZATION	Page	17
4.0	TOOLING PRACTICES FOR BUYER-FURNISHED TOOLS	Page	17
5.0	LISTINGS OF SELLER-FABRICATED/PROCURED ST OR STE	Page	17
6.0	DRAWINGS, SKETCHES, TOOL DESIGNS, ETC.	Page	18
7.0	CALIBRATION AND RE-CALIBRATION OF BUYER-FURNISHED OR SELLER-FABRICATED STE	Page	18
8.0	TOOLING USE AND TOLERANCE REQUIREMENTS	Page	18
9.0	QUALITY ASSURANCE REQUIREMENTS OF SELLER-OWNED OR SELLER-FABRICATED PRODUCTION TOOLING	Page	18

PART IV. APPENDIX "A"

1.0	GENERAL	Page	19
2.0	PRESERVATION OF BUYER FURNISHED TOOLS	Page	19
3.0	STANDARD REPAIR, TOLERANCE AND COORDINATION	Page	20

*** LIST OF FIGURES and CHARTS**

1.	"TO MATCH" HOLE PATTERNS – Figure 1	Page	8
2.	TOOLING HOLE TOLERANCE – Figure 2	Page	20
3.	DOUBLE RAIL (INTERCHANGEABLE) – Figure 3	Page	21
4.	DOUBLE RAIL (REPLACEABLE AND NON-I/R, NET OR WITH EXCESS) – Figure 4	Page	21
5.	SINGLE RAIL SETBACK TYPE – Figure 5	Page	22
6.	PRODUCTION TOOL TO CONTROL TOOL – Figure 6	Page	26
7.	COORDINATION PIN TOLERANCE (I/R) – Table 1.0	Page	23
8.	COORDINATION PIN TOLERANCE – Table 2.0	Page	24
9.	PRODUCTION ITEM TO PRODUCTION TOOL – Table 3.0	Page	25

*** APPLICABLE DOCUMENTS**

- * PM-4053 PROCESS MANUAL – Access limited due to Proprietary Data contained therein. Sellers contracted to fabricate or rework Special Tooling shall contact Buyer to submit access request.

PO APPENDIX T – Special Tooling Identification requirements for Non Recurring Tools.

PART I

AIRCRAFT ITEMS AND TOOLING - SELLER REQUIREMENTS

1.0 GENERAL

1.1 This Tooling Manual ("Manual") contains the contractual requirements to properly control and maintain Buyer-furnished and/or Seller-manufactured Special Tooling ("ST"), Support Equipment ("SE"), Manufacturing Support Equipment ("MSE"), Special Test Equipment ("STE") and Manufacturing Test Equipment ("MTE") for Buyer, as such terms are hereinafter defined, used to produce Items for Buyer.

1.2 This Manual contains general and specific requirements that are applicable as specified in this Purchase Order ("PO"). The terms "Item" or its plural "Items", "PO", "Seller", and "Buyer" as used herein, have the same meaning as the terms "Work", "Contract", "SELLER", and "LOCKHEED MARTIN", respectively.

1.3 Access to this manual can be found on the Material Management Home Page at <http://www.lockheedmartin.com/aeronautics/materialmanagement>, under Quality Requirements, Control Specs.

2.0 TOOLING DEFINITIONS

2.1. ST means all jigs, dies, fixtures, molds, patterns, taps, gages, other equipment and manufacturing aids, and replacements which are of such a specialized nature that without substantial modification or alteration, their use is limited to the development or production of particular supplies or Items thereof, or the performance of particular services.

2.2 Modification Kit Tool ("MKT") is categorized as ST and used to update or modify aircraft assemblies and structures.

2.3 "Tooling Tools" means all gage's used by Seller to control the fabrication or coordination of production tooling, holes, Interchangeable-Replaceable ("I/R") features, critical mating points and surfaces or contours it represents. Tooling Tools are for tooling purposes only and shall not be used for production purposes.

2.4 "Seller-Owned Tooling" means all ST and Tooling Tools owned by Seller and used in the process of fabricating, inspecting, assembling and coordinating of particular Items and/or tools as described in paragraphs 2.1 and 2.3.

2.5 STE means either single or multipurpose integrated test Items engineered, designed, fabricated or modified to accomplish special purpose testing. STE consists of Items that are interconnected and interdependent so as to become a new functional entity for special testing purposes. STE excludes:

- Consumable property
- ST
- Facility Items (except necessary improvements for installing STE)

- Plant equipment Items used for general plant testing purposes

2.6 MSE is used in manufacturing operations to support, test or prove the functional operation of an Item.

2.7 MSE consists of the following types of Items and shall be considered United States ("U.S.") Government property:

2.7.1 SE required to make an Item operational in its intended environment. SE includes the following:

- Common and Standard SE – For use on more than one type Item
- Peculiar or Non-Standard SE – For use on a peculiar or specific Item

2.7.2 MTE required for use in manufacturing operations to conduct tests and/or prove the functional operation of a specific Item. MTE is peculiar to manufacturing in that it is not normally used by Buyer to support the Item in an operational environment.

2.8 "Control Media" means tooling and electronic data used to control I/R and/or coordinating points and are categorized as follows:

2.8.1 "Master Tooling" – Master tool gages used to establish dimensions and features during manufacture of Production Tools which control I/R and/or coordination points of production Items. Unless Buyer has provided Seller with prior specific written authorization to do so, Seller shall not use Master Tooling for production purposes, i.e., Item verification, drilling, trimming or forming.

2.8.2 "Controlled Production Tooling" – Tooling such as jigs and fixtures used to establish dimensions and features of Items and which control I/R and/or coordination points of those Items.

2.8.3 "Electronic Data" – Computer-generated electronic data used to establish dimensions and features during manufacture of production tools which control I/R and also used during fabrication of production Items for control of I/R features, e.g., trim, attach holes.

2.9 Manufacturing Engineering Data Model ("MEDM") – An electronic Computer Aided Three-Dimensional Interactive Application ("CATIA") model used to fabricate designed or non-designed tools. The MEDM may contain contour, reference lines, attach pattern, periphery, tooling holes, text, etc. in any combination for tool fabrication and/or the tool design. The MEDM may contain specific inspection points designated by Buyer's Integrated Product Team ("IPT"). The inspection point coordinates can be recorded electronically and can be displayed on a paper plot of the MEDM. A Coordinate Measuring Machine ("CMM") or other inspection device control program may be created from the MEDMs containing inspection point information defined by Buyer.

2.10 "Production Tools" means jigs, fixtures, dies, and other tools made for use in manufacturing Items.

2.11 Interchangeable-Alterable ("IA") Items mean controlled interchangeable manufactured Items that may require limited alteration of specific features or opening edges during installation. The alteration, if any required, may be the removal and/or addition of edge material. The alteration

task is only accomplished during installation.

2.12 Electronic Supplier Problem and Resolution (“e-SPaR”) - This online system is available on the Buyer’s Material Management Homepage at <http://www.lockheedmartin.com/aeronautics/materialmanagement> and is the approved system to request information regarding PO requirements.

2.13 Seller Aircraft Tooling Report (“SATR”)

2.13.1 This online system is available on the Buyer’s Material Management Homepage and was created to provide Seller with a traceable electronic means of reporting ST discrepancies and achieving disposition authorization from Buyer’s program representative.

2.13.2 Access is granted by applying for an account on the Buyer’s Material Management Homepage at <http://www.lockheedmartin.com/aeronautics/materialmanagement>. Highlight “Quality Requirements” and select “Corrective Action”.

2.13.3 A SATR is a document initiated by Seller to document a discrepant Buyer-furnished ST condition. Buyer shall reply with authorization for repair, if required, of "out of engineering" discrepancies or conditions.

3.0 INTERCHANGEABLE- REPLACEABLE (“I/R”)

3.1 Seller shall comply with I/R requirements imposed by this PO.

3.2 “Interchangeable Items” – Interchangeable Items are completely finished and have designed/controlled features which allow them to be installed, removed, or replaced without alteration, misalignment, or damage to installed or adjoining Items. Interchangeable Items require only attaching means (bolts, nuts, screws, pins, etc.) to install. Interchangeable Items do not require any fabrication operations such as cutting, filing, drilling, hammering or forcing at the point of installation.

3.3 “Replaceable Items” – Replaceable Items are partially finished and have designed/controlled features which require alteration of the Items in addition to the normal application and/or methods of attachment at the point of installation. Such alterations are limited to specified areas and may include drilling, filing, trimming, bending, etc.

3.4 “Interchangeable Category Items” – Items so designated are typically Items which are attached by bolts or screws, readily removable and replaceable. Such Items are designed in such a manner that all like Items made within the engineering drawing tolerances will substitute one for another. Interchangeable Category Items are Items that are maintained by Seller through use of normal manufacturing methods and compliance with engineering drawing dimension tolerances, without the use of I/R Control Media.

4.0 “TO MATCH” HOLE PATTERNS AND OTHER I/R FEATURES

- * 4.1 The term “To Match”, when specified on Buyer engineering drawings relative to hole locations, indicates that the dimensions including tolerances, even when met, may not necessarily ensure physical mating of Item hole patterns at the point of installation. This is true

IMPORTANT NOTICE: A hard copy of this document may not be the document currently in effect. The current version is ALWAYS the version on the LOCKHEED MARTIN network.

even though from a dimensional standpoint the features are within engineering drawing tolerance limits. "To Match" features are physically established, within engineering drawing tolerance limits, through the use of Master Tooling. Once Seller physically establishes the features, Seller must maintain the actual positions to achieve and sustain "To Match" capability (example in Figure 1).

4.2 Buyer's Tooling Policy, relative to Item features requiring physical control for configuration management purposes, is to provide Control Media, e.g., master gage, tooling gage, master plate, MEDM or other Electronic Data, to establish and maintain those Item features requiring control, over and above only the engineering drawing dimensions and their associated tolerances. If the Item feature requiring control has a critical configuration relationship requirement to other Item features, the Control Media will also establish those Item feature relationships, one to the other. Additionally, even though Item features may be within engineering drawing dimension tolerance band for those features, if an actual feature location does not comply with applicable Control Media allowed tolerance deviation, the feature location is not acceptable.

4.3 Buyer's Control Media drawing, if applicable, will denote maximum tool deviations permitted in feature location and/or relation to critical features that are acceptable on finished Items.

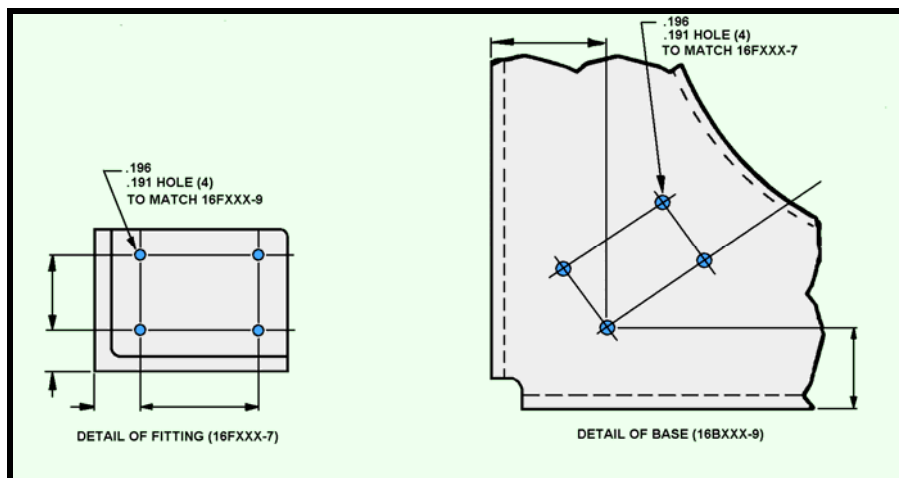

Figure 1. Example of "To Match" hole patterns as defined on engineering drawings.

5.0 CONTROL OF RECORDS

5.1 Seller shall include the following information for each tool, as a minimum, in its records:

5.1.1 Tool number assigned by Buyer

5.1.2 Buyer-assigned Item number and "Also Use" Item number/dash number that the tool will fabricate

5.1.3 Tool Code

5.1.4 Purchase order number (or other authorization) under which the tool was furnished to or fabricated by Seller

5.1.5 The Government or Commercial prime contract number indicated in this PO and, if applicable, type of Item (e.g., ST, STE, SE, MTE, etc.)

5.1.6 Serial number of the shipping document for tools received by Seller from Buyer or another authorized party and all packing sheet information.

5.1.7 Tool location rework, progressive inspection, calibration, maintenance and acceptance dates

5.1.8 Copy of the completed Certified Property List ("CPL") provided by Buyer

5.1.9 Indication that tool is accountable to Buyer

5.1.10 Authority for disposition of tools which are no longer in Seller's possession

5.2 Seller, on a current basis, shall maintain tool designs, sketches, photographs, and schematic drawings used in the fabrication, testing, or calibration of tooling. Seller shall show tool manufacturing tolerances on the tool design. Seller shall provide Buyer disposition for this data, as requested, at the same time disposition for related tooling is given.

5.3 Prior to tool fabrication, Seller shall submit a copy of Seller's tool designs or concepts for Seller-owned and supplemental tools, including casting and forging tools, to Buyer for review and approval. If Buyer deems it necessary, Buyer will provide concept or design changes to Seller.

6.0 CERTIFIED PROPERTY LIST – CPL-11300

6.1 Seller shall list tools authorized by this PO on Form 1130 (FWP-4456), CPL which is available on the Buyer's Material Management Homepage at <http://www.lockheedmartin.com/aeronautics/materialmanagement> under Quality Requirements.

6.2 Certain forging die type tooling, as mutually determined by Seller and Buyer, is exempted from CPL accountability requirements. The exemptions are required due to the uniqueness of forging die tooling and potential proprietary Seller manufacturing processes. Refer to paragraphs 5.1 through 5.3 for inventory/record requirements.

7.0 CONTROL OF BUYER-FURNISHED TOOLS

7.1 Seller shall acknowledge receipt of all tools, including SE, MTE and STE, by the signature of an authorized representative of Seller on the CPL and return of the signed CPL to Buyer.

7.2 Upon receipt of boxed and sealed tools, Seller shall notify Buyer's Procurement Quality Assurance Field Engineer ("PQAFE") to break the seal of the container. The PQAFE and Seller shall visually inspect the tool and contents for completeness and damage. Seller's Quality Assurance ("QA") personnel are allowed to open sealed containers in the event that PQAFE is unavailable. Seller shall complete form FWP-1209 "Gage Storage Record" accompanying the tool for Fort Worth tools or form GD1856-1 "Tooling Log Book" for Marietta tools. Seller shall enter discrepancies, if any, in the remarks column. If Seller does not receive the applicable form with the tool, Seller shall initiate an e-SPaR requesting the correct form.

7.3 In no case shall Seller attempt to rework, in any manner, Buyer-furnished tooling without prior written authorization from Buyer. Rework is defined as any modification to a tool that affects the tool configuration such as; hole patterns, contour, periphery, etc.

- ** 7.3.1 Seller shall review Buyer authorization for repair and contact PQAFE to discuss appropriate level of verification or oversight required to ensure that rework has been completed.
- ** 7.3.2 All I/R tooling and tooling used as a media of acceptance shall require delta FAI demonstrations upon completion of rework, unless the reworked tool is coordinated to designated control media. Additional I/R and non-I/R repair, preservation and coordination guidance is provided, but not limited to, Part IV of this Manual.
- ** 7.3.3 Seller shall initiate a SATR to receive Buyer authorization to rework and/or repair Buyer-furnished ST

7.4 Seller shall maintain the ability to produce the original, or any subsequent Item configuration, including spares, unless changes made by Buyer's engineering are retroactive to the original point of affectivity of Item. Seller shall accomplish this by fabricating other Control Media for its use, or from Buyer-furnished Control Media.

- * 7.5 When Buyer authorizes rework and when a tool is capable of producing earlier configurations, Seller shall re-identify the tool to the new configuration Item number. When Buyer-authorized rework and/or modification will render a tool incapable of producing earlier configurations without extensive alteration, Seller shall notify Buyer prior to continuing any rework and request additional specific instructions for tool rework, or for potentially manufacturing new additional tooling.

7.6 Seller shall submit an e-SPaR with itemized listing of any lost, damaged, or destroyed ("LDD") U.S. Government tooling to Buyer. Seller shall also include the following information on the e-SPaR submission for LDD tooling:

- A narrative description of the incident and corrective action taken to prevent recurrence
- Original purchase order number
- Original purchase order line Item number
- Original tool number – where applicable or for replacement of ST only
- Original Tool Code – where applicable or for replacement of ST only
- Original tool asset number (barcode number) – where applicable or for replacement of ST only

7.7 Seller or Seller's subcontractor(s) shall permanently identify and control all non-recurring ST manufactured for this PO as specified in PO Appendix T.

8.0 TOOL QUALITY CODE CATEGORIES

8.1 Seller shall fabricate non-recurring tools to the quality code stated in this PO. If no quality code is stated in this PO, Seller tools shall be quality Code 2.

8.2 "Code 1" – These tools are made of the best and most durable practical materials available. They are capable of producing Items with critical tolerances at an accelerated production rate

without addition or changes in construction. However, duplicate tools may be required by Buyer in some cases.

8.3 "Code 2" – Incomplete and/or low production rate quality tools that can be revised at a later date to meet the needs of an accelerated production program (capable of being reworked to Code 1 tools). Combined operational tools comparable to Code 1 tools used for performing multiple operations. Tools that can be revised by separating them into Items or sections to make one or more Code 1 tools if required by production scheduling.

8.4 "Code 3" – Permanent type tools made from moderately priced materials and used for low production rates or a limited number of ship requirements. These tools must be capable of holding blueprint tolerances. If production is greatly increased, it may be necessary to replace these tools.

8.5 "Code 4" – Low production rate tools made of low cost materials. These tools are used for accomplishing emergency, temporary, or off-station production operations. They must be capable of making Items or assemblies that will meet minimum quality control standards. When making Items with this type of tooling, a maximum amount of handwork, standard setups, layouts, etc. is permitted.

8.6 "Code 5" – Lowest cost tooling that is used for production operations. These tools are needed for making Items or assemblies where it is not possible to make them by layout, handwork, standard tools, or setups. Use of handwork, standard clamps, etc., is permitted when finishing Items to meet engineering tolerances.

- * **9.0 TOOL PROTECTION AND STORAGE REQUIREMENTS** – Seller shall ensure their quality system maintains surveillance in order for Control Media to not be abused or damaged while out of storage/shipping containers. Seller shall take particular care when tools are being loaded into and removed from jigs and fixtures. Preservation requirements are illustrated in Part IV of this Manual.

10.0 SHIPPING INSTRUCTIONS

10.1 Buyer shall specify destination and mode of transportation for tools that are to be shipped from any point of origin. Seller and Buyer shall determine preservation, packaging, and/or crating requirements when shipment becomes necessary in accordance with this PO.

10.2 Seller shall provide advance notice to the PQAFE when performing closure of a Control Media container.

10.3 Seller shall contact PQAFE for closure of the Control Media container. If PQAFE is unavailable within two (2) business days to witness the closure of the Control Media container, Seller's QA shall fill out the form FWP-1209, "Gage Storage Record" or tooling log book as applicable. Seller's QA and/or PQAFE shall verify the following are complete and included before closure and sealing:

- A. Control Media contents are complete
- B. Applicable surfaces are greased
- C. Contents are shored
- D. Gage storage record is stamped and complete

10.4 Prior to shipment, Seller shall note physical damage, if any, to the tools and shall document all such damage, if any, as specified in this Manual in Part I, Paragraphs 2.12 and 2.13.

10.5 Seller shall use lead seals, steel stamped by Seller, to seal the Control Media box.

10.6 If movement of Control Media will affect Seller's ability to meet a delivery schedule, Seller shall immediately notify Buyer.

10.7 At such time Buyer determines that Buyer-furnished tools located at Seller's facility are to be dispositioned, Buyer shall list the tools on form SF1432/1433 "Inventory Schedule" and forward the Inventory Schedule or a listing, as appropriate, to Seller. Upon receipt of the completed Inventory Schedule or listing, Seller shall process the listed tools as follows:

- Segregate the tools to a secured storage area.
- Indicate on the Inventory Schedule or listing, in the space provided, the specific location of the segregated tools and Seller representative to be contacted regarding final disposition instructions.
- Sign and return the Inventory Schedule or listing to Buyer.

10.8 Upon Buyer's written notification and transfer of tool title from Buyer to Seller, Seller shall remove all evidence of ownership markings from tools and tool containers or render markings unrecognizable. This tooling identification removal includes, but is not limited to, the following:

- Ownership markings on plaques
- Barcodes
- Steel stamping
- Vibro-engrave etching
- Paint markings

Seller shall reference FAR 45.506 for contractor requirements of U.S. Government-owned property. Seller shall exercise caution to ensure that Tool Code and part number identifications are not removed.

11.0 TOOLING PERIODIC INSPECTION AND VERIFICATION PROGRAM ("PI/V")

11.1 PI/V is a process comprised of the cyclical verification of "Selected Tooling", as defined in paragraph 11.2, used as a media of acceptance of a feature(s) of an Item.

- Example of Selected Tooling that would be placed into a PI/V recall cycle: A Drill Jig ("DRJI") used to drill four holes in an aircraft part and subsequently used to verify the same four holes spacing, location, diameter, depth, etc.

* 11.1.1 Seller shall place all Buyer-furnished or Seller-owned Inspection Gages ("INGA") or Check Fixtures ("CKFX") into a PI/V recall cycle.

11.1.2 Seller shall place all tooling that controls I/R into a PI/V recall cycle.

* 11.2 "Selected Tooling" is defined as any Buyer-furnished or Seller-owned tool used as a media of acceptance for a feature of any Item deliverable to Buyer. Seller shall be responsible for establishing a PI/V procedure for Buyer-furnished or Seller-owned tools used as a media of

acceptance to produce Buyer Items, and present proof of administering these procedures to Buyer or PQAFE upon request. Tools designated by Buyer as Master Tooling or Tooling Tools and used for coordinating purposes only, do not require PI/V but do require unique preservation controls to ensure configuration and integrity of tools are maintained. Preservation, maintenance and standard repair specifications are illustrated in Part IV of this Manual.

- * 11.3 Seller shall perform PI/V of Selected Tooling at Seller's facility annually and review tool history after each PI/V to determine whether tool performance has been such that subsequent periodic cycles can be increased, remain as scheduled or be reduced. Seller shall coordinate any deviations from the annual requirement through Buyer and applicable Buyer's Program Management, e.g. F-16, F-22, C-130, etc.

11.4 Seller shall place all tooling in storage that is not in use and designate same tooling as "Inactive". Seller shall perform PI/V on all "Inactive" tools prior to their being returned to "Active" status.

11.5 On a tool-by-tool basis, with appropriate written authorization from Buyer and in the absence of designated Control Media, Seller shall accomplish PI/V by means of visual inspection in lieu of performing physical tooling coordination. Seller shall accomplish the visual PI/V using the below criteria:

- Seller shall use "Fit Check Items" or originally manufactured Items to the maximum extent possible.
- Seller shall obtain an up-to-date quality history data file for Item(s) affected by applicable tooling, and perform a quality analysis relative to any discrepancies which may be tool related. Seller shall take appropriate action based on analysis results.
- Seller shall perform a visual tool examination for obvious damage, excessive wear, broken, loose, worn, or missing Items, e.g., both integral and removable, bushings, pins, and clamps.
- Seller shall immediately identify any adverse conditions revealed as a result of the above actions and request direction from Buyer by submitting a SATR.
- Seller shall determine any adverse affect on Items in work, in Seller's inventory, or delivered to Buyer and take appropriate action to segregate, document and/or notify Buyer.

11.6 Seller shall request from Buyer all necessary Tooling Tools to perform PI/V coordination back to Control Media.

11.7 Seller's digitization of Master Tooling or Tooling Tools is an acceptable alternative to Seller storing Master Tooling or Tooling Tools at Seller's facility. Digitizing data is a method of retaining the Master Tooling features. Seller shall use this digitized data to perform acceptance of features of Buyer deliverable Items. Digitized data does not require PI/V.

- ** CAUTION: Digitized data is acceptable for this PO only. Seller shall verify any additional purchase order for the same deliverable Item is to the latest revision for Master Tooling or Tooling Tools. Seller shall verify the digitized masters are to the latest configuration. When performing

coordination or verification of a physical tool back to digitized data, applicable tolerances apply as if performing a tool-to-tool coordination. Tolerance requirements are illustrated in Part IV of this Manual.

12.0 TOOLING PERIODIC INSPECTION AND RE-VERIFICATION (PI/V) RECORDS

12.1 Seller shall maintain a record on all tools requiring PI/V. Such record shall list:

- Buyer-assigned tool number
- Buyer-assigned tool code
- Buyer-assigned part number
- Next PI/V recall date
- Quality acceptance verification
- Control Media used, if applicable, shall be recorded in the PI/V record
- History of previous PI/V
- Date of PI/V
- PI/V check sheet (if applicable)
- Inactive tools

12.2 Upon Buyer or Buyer Representative's request, Seller shall present the PI/V record.

12.3 Seller shall update or revise the data in its PI/V record to meet the requirements of 12.1 on the next PI/V cycle of each tool.

***** END PART I*****

PART II

MANUFACTURED SPECIAL TOOLING SELLER REQUIREMENTS

1.0 GENERAL – Part II of this Manual is applicable to the manufacture of ST and is in addition to requirements defined in Part I.

2.0 DEFINITIONS – “REDLINE TOOL DESIGNS” – “Redline Tool Design” is a tool design drawing made by Buyer or Seller which has modifications marked in red ink. Such modifications provide clarification to tool fabrication changes and are known as “Redline Tool Design” changes. The redline change to the drawing is made with the understanding that a formal release incorporating the redline change(s) will be forthcoming. Detailed instructions about “Redline Tool Design” requirements are set forth in PM-4053.

3.0 SPECIAL TOOLING INSPECTION AND QUALITY REQUIREMENTS

3.1 Seller shall comply with stress relief, annealing, and penetrant inspection operations in accordance with PM-4053. Seller shall flow the following instructions in purchase orders to their sub-tiers:

- Buyer identification number for Seller
- Buyer identification number for Seller's sub-tier (if applicable)
- All applicable Buyer-imposed specifications

IMPORTANT NOTICE: A hard copy of this document may not be the document currently in effect. The current version is ALWAYS the version on the LOCKHEED MARTIN network.

3.2 Unless otherwise stated in Buyer's Build-to-Package ("BTP"), CMM, theodolite, photogrammetry, calibrated machine probe, and/or laser tracking are the only acceptable methods for contour verification, and are the preferred methods for hole pattern verification. CMM inspection is the overall preferred method for verification. Exception: if the CMM output data is such that the data is not electronically transmittable to a CATIA model for review, and/or calculations must be performed manually in order to complete the inspection activity (e.g., vector data must be manually calculated for hole locations), the use of theodolites or laser tracking when the data can be readily uploaded electronically to CATIA are then the preferred methods of inspection.

3.3 Inspection Grid Pattern: Unless otherwise stated in Buyer's BTP, Seller shall inspect surfaces requiring verification using the following grid pattern:

3.3.1 A maximum distance of two (2) inches between points along contour for complex and/or compound surfaces. There are no minimum distance requirements.

3.3.2 A maximum distance of six (6) inches between points for planar surfaces. There are no minimum distance requirements.

3.4 Seller shall not proceed to the next verification milestone without prior written authorization by PQAFE in the Progressive Inspection Log ("PIL").

** 3.5 Seller shall establish and/or maintain a quality system which requires the inspection of all dimensions of a tool. Seller's QA shall log all three (3) place dimensions, (2 place for metric) or any dimensions specifically identified for inclusion in Buyer's BTP, into the PIL, but is not required to log one (1) and two (2) place dimensions, (1 place for metric) in the PIL.

3.6 Seller shall include a statement in the PIL to document inspection and acceptance of all one and two place dimensions, (1 place for metric).

3.7 Seller shall document tooling anomalies, requests for deviation or waiver, and other non-conformances, if any, identified during or subsequent to Seller's tool manufacturing and acceptance process by submitting a SATR.

4.0 TOOL IDENTIFICATION

4.1 Tool identification for Buyer tooling is controlled by PM-4053. Seller shall check for the latest revision of PM-4053 requirements.

4.2 Seller shall identify each Seller-manufactured ST in a conspicuous place using a permanent method such as stamping, engraving, etching, stenciling, etc. as required per PM-4053.

5.0 PROCESS FOR TRANSFERRING TOOL DESIGNS FROM SELLER TO BUYER

5.1 Digital Data Transfer – The transfer of digital data between Seller and Buyer is controlled through Buyer's BTP Computer Aided Design/Computer Aided Manufacturing (CAD/CAM) Engineering Data Transfer Group. Buyer shall identify Seller points of contact ("POC") for setup of digital data transfer capabilities and forward this information to Buyer's BTP CAD/CAM Engineering Data Transfer Group. Buyer's BTP CAD/CAM Engineering Data Transfer Group shall contact Seller POCs and identify required capabilities, data transfer site information,

(including passwords, directory information, email notifications, and access controls), and how Seller will be notified of data transfer activities.

5.2 Hardcopy Data Transfer – Seller shall coordinate all hard copy transfer of designs through Buyer.

6.0 SEALING CRITICAL LOCATORS

6.1 Torque seal requirements for tooling are defined by site and program.

6.2 Fort Worth requirements: F-22A tooling – **Pink**
All other tooling – **Purple**

6.3 Marietta requirements: Tooling – **Pink**

6.4 Palmdale requirements: Tooling – **Pink**

***** END PART II *****

PART III

INTERNATIONAL SELLER REQUIREMENTS

1.0 GENERAL

1.1 Part III is applicable to F-16, F-2 and F-22 programs only where Buyer furnishes Seller with Items and/or material to support Buyer's BTP.

1.2 Fabrication requirements of ST, STE, and MKT by Seller or Seller's sub-tiers to produce Buyer-designed controlled Items and aircraft modifications, as specifically contracted by this PO, are defined in Part II of this Manual and controlled by PM-4053.

2.0 CONTROL OF SE, MTE AND STE

2.1 Receipt of SE – Seller shall return a stamped copy of SE receiver to Buyer within five (5) working days upon receipt of SE.

2.1.1 Maintenance and repair parts for SE – Seller shall requisition maintenance and repair parts for the SE provided as MSE from Buyer.

2.1.2 Modification of SE provided as MSE peculiar modification of SE – Seller shall receive a tool order, a peculiar modification kit and written Buyer authorization. Upon completion of modification, Seller will return the stamped off / approved copy of the tool order to Buyer.

2.1.3 Time Compliance Tech Order ("TCTO") modification of SE – Seller shall receive a TCTO modification kit and written authorization from Buyer authorizing Seller to install the kit. Upon completion of kit installation, Seller shall return a completed Letter of Certification ("LOC") to Buyer.

2.2 Receipt of MTE – Seller shall acknowledge receipt of the CPL by signing and returning the original CPL to Buyer.

2.2.1 Maintenance and Repair parts for MTE – Seller shall requisition maintenance and repair parts for the MTE from Buyer.

2.2.2 Modification of MTE – Seller shall not perform modification on MTE without prior written authorization from Buyer.

2.3 Receipt, Maintenance and Modification of STE other than MTE Receipt – Seller shall acknowledge receipt of STE, if any, by signing and returning the original CPL to Buyer within five (5) working days after receipt of STE.

2.3.1 Maintenance and Repair Parts – Seller shall requisition maintenance and repair parts for STE from Buyer.

2.3.2 Modification – Seller shall not perform modification of STE without prior written authorization and direction from Buyer.

2.4 Disposition of SE, MTE and STE – Seller shall request disposition instructions from Buyer when SE, MTE and STE become surplus or obsolete.

3.0 CHANGE AUTHORIZATION

3.1 Seller shall not rework or in any way alter control tools without prior Buyer written authorization with a revised CPL and tool drawings, if required, to rework and/or re-stamp control tools.

3.2 Seller shall return to Buyer the stamped and signed tool order and CPL.

4.0 TOOLING PRACTICES FOR BUYER-FURNISHED TOOLS – Category “A” tools are control tools that establish dimensions and features of production tools which control I/R and/or coordination points of other production tools. Seller shall use these tools as Control Media only to fabricate production and inspection tools. The following is a list of the affected tools:

- COMG – Component Master Gage
- FCGA – Facility Gage
- MSFM/TOFM - For contour only. Lines on MSFM/TOFM are for reference only and
- Seller may revise or add these lines to satisfy their production tool requirements without prior written authorization from Buyer.
- MSGA – Master Gage
- MSPE – Master Plate
- PDSE – Production Samples (Tube)
- TOGA – Tooling Gage
- TOSE – Tooling Sample (Welded Tubes/Ducts)
- Any tool identified by this PO and provided as a control tool

5.0 LISTINGS OF SELLER-FABRICATED/PROCURED ST OR STE

5.1 Seller shall establish and maintain a part list and tool list, by manufacturer's part number, of ST or STE fabricated or procured by Seller, as required by Buyer. Seller shall not include any Buyer-furnished ST or STE in the list(s).

5.2 Seller shall produce and maintain listings of all tools required to fabricate Federal Identification Item Number ("FIIN") spare Items.

6.0 DRAWINGS, SKETCHES, TOOL DESIGNS, ETC.

6.1 Seller shall maintain Seller-owned or Buyer-furnished current tool designs, sketches, photographs, and schematic drawings used in the fabrication, testing, or calibration of tooling. Seller shall provide a disposition of this data at the same time disposition for related tooling is given, as requested by Buyer.

6.2 Seller shall ensure Seller's STE drawings of any electrical, electronic, hydraulic or pneumatic type, at a minimum, consist of a schematic with component parts called out by characteristics and/or part number, including adequate calibration and operation instructions.

7.0 CALIBRATION AND RE-CALIBRATION OF BUYER-FURNISHED OR SELLER-FABRICATED STE

7.1 Seller shall develop and maintain a schedule for maintaining calibration of Buyer-furnished or Seller-fabricated STE. Seller's schedule is subject to approval of Buyer's representative and Seller shall ensure such schedule includes the following:

- Name and function of test equipment
- Serial or identification number of test equipment
- Criteria or standard to which test equipment is checked
- Frequency of test

7.2 Buyer shall determine mode of transportation for STE and make arrangements for shipment, when STE is required at another location.

8.0 TOOLING USE AND TOLERANCE REQUIREMENTS – Seller shall comply with the tool usage and tolerance requirements as defined in PM-4053, unless unique requirements are otherwise specified on the Statement of Work ("SOW"), BTP, or this PO.

9.0 QUALITY ASSURANCE REQUIREMENTS OF SELLER-OWNED OR SELLER-FABRICATED PRODUCTION TOOLING

9.1 Seller shall submit applicable data of all Seller-fabricated or Seller-owned production tooling to Buyer's Program management for review and approval prior to release of tool for trial run or First Article Inspection ("FAI"). Such data may include, but is not limited to, engineering data, drawings, designs, Master Layouts ("MEL"), etc. In addition, Seller shall use data generated by trial run to satisfy Buyer's FAI requirement, if witnessed by Buyer's representative or designated alternate.

9.2 Seller shall inspect all Seller-fabricated production tooling, which has been manufactured utilizing Buyer-furnished Control Media, by utilizing applicable tooling tolerances defined in PM-4053.

9.3 Seller shall inspect or re-verify subsequent parts produced utilizing Seller-fabricated production tooling to the criteria defined in Part I, Section 4.0 "To Match" Hole Patterns of this Manual and as further defined in PM-4053.

9.4 Seller shall ensure each Item manufactured with Seller-fabricated ST and STE is identified in a conspicuous place with the current part number and dash number, Tool Code, any peculiar tool number, the "Also Use" current part number (if applicable), and/or Engineering Change Notice ("ECN"). Seller shall identify STE and MKT as "Property of USGOVT" and ST as "Property of Seller", or as directed by this PO.

***** END OF PART III *****

**** PART IV**

APPENDIX "A"

1.0 GENERAL

1.1 Part IV is applicable for all programs at all sites and is included in this Manual as specification guidance for the preservation, repair and coordination of Buyer-furnished tools.

1.2 Part IV is provided as specification requirements for performing new make, rework or coordination of Buyer-furnished tools.

2.0 PRESERVATION OF BUYER-FURNISHED TOOLS

2.1 To ensure the preservation of Buyer-furnished tools, Seller shall:

- Maintain all Buyer-furnished tools in a rust-free and/or non-contaminated condition before shipping, storing or placing into production.
- Use, store inside a building and handle with care at all times all fiberglass and composite tooling to prevent accidental damage to critical points, surfaces, holes, etc.
- For fiberglass and composite tools stored in a controlled area other than 75 degrees +/- 10 degrees, protect such tools from excessive adverse conditions of heat, cold, sunlight, and moisture. In addition, when fiberglass and composite tools are subject to temperatures outside these limits, use such tools only after a period of temperature stabilization (a period of 24 hours is required for each 10 degree change necessary to bring the tool back within the approved temperature limits, not to exceed 72 hours).
- Apply a MIL-C-16173 Grade 2 protective coating to unpainted alloy surfaces if stored sheltered from the elements, and a MIL-C-16173 Grade 1 protective coating if stored exposed to the elements.
- Apply a protective coating per MIL-P-3038 to plywood, Masonite, etc. if stored exposed to the elements.

2.2 Seller shall provide storage containers for all Master Tooling and Inspection Gages fabricated with Buyer tool numbers. Seller shall provide containers to specifications identified on the tool

design. Seller shall ensure the containers provide adequate support and protection of tools from the environment and mishandling during movement.

3.0 STANDARD REPAIR, TOLERANCES AND COORDINATION

3.1 For standard repairs, tolerances and coordination of Buyer-furnished tools, Seller shall:

- Produce tooling holes which have a hole size tolerance of $+.005/-0.000$ and are located within one-half of such tolerance.
- Locate and identify tooling holes on Item(s), as directed by Buyer, or illustrated in Figure 2. When Seller must plug tooling holes, Seller shall provide a general note to that effect as illustrated in Figure 2.

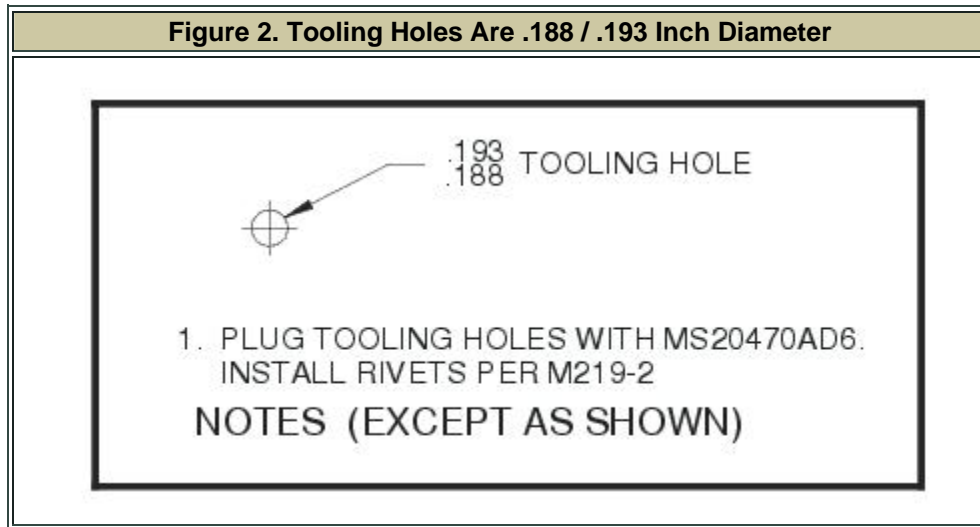

- Maintain allowable production tolerances on interchangeable Items produced/verified with controlled production tooling as illustrated in Figure 3.
- Utilize a check pin for all I/R hole patterns to ensure patterns are made in accordance with the tool coordination tolerance tables included herein.
- Utilize controlled production tooling to check and verify allowable production tolerances on interchangeable Items are from .010 smaller, to .010 larger than the tool, as illustrated in Figure 3.
- Utilize a check pin to check and verify the I/R hole pattern is made in accordance with the tool coordination tolerance tables included herein.

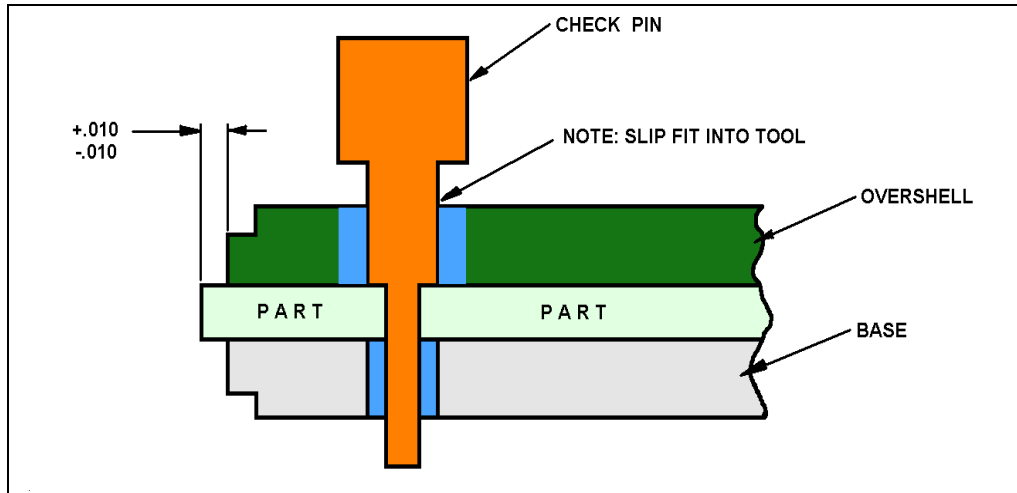

Figure 3. DOUBLE RAIL (INTERCHANGEABLE)

- Verify replaceable and non-I/R part perimeters produced with production trim tools or check fixtures have allowable production tolerances from a maximum of .030 smaller, to a maximum of .030 larger than the tool, relative to the engineering drawing applicable feature tolerance as illustrated in Figure 4 and 5.
- Verify perimeters are plus or minus .030 tolerances, unless otherwise stated on face of drawing. Example: An E.O.P. dimensioned as $+.015$, $-.030$ from a F.S., W.L., B.L. would apply. A "Tab" dimensioned as $+/- .010$ for overall width, would apply if stated on the drawing.
- Utilize a check pin to verify all I/R hole patterns are made in accordance with the tool coordination tolerance table.

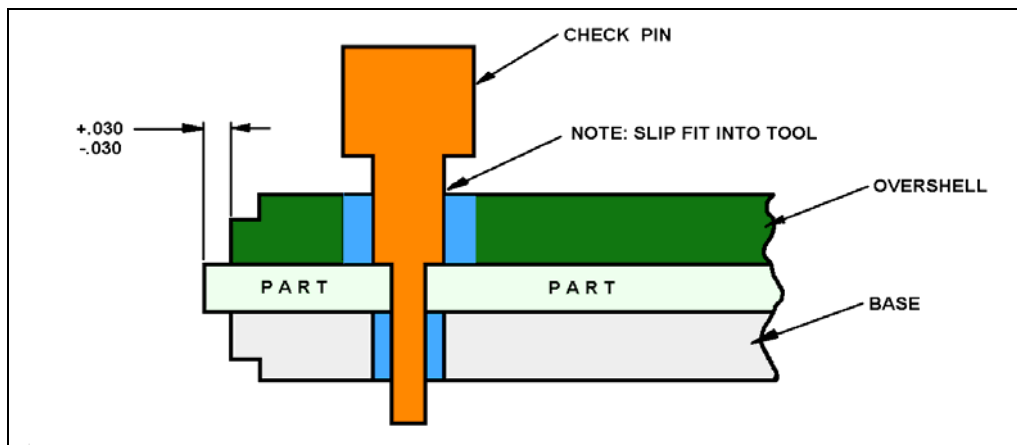

Figure 4. DOUBLE RAIL (REPLACEABLE, AND NON I/R, NET OR WITH EXCESS)

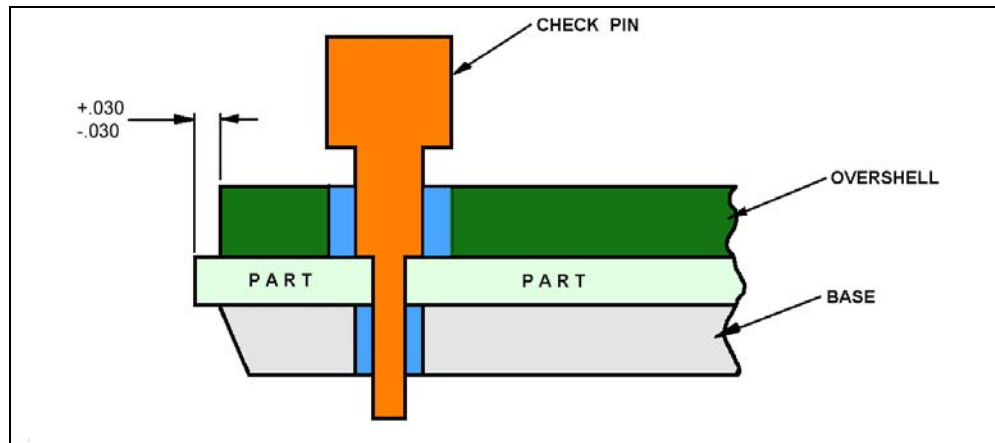

Figure 5. SINGLE RAIL
SETBACK TYPE (REPLACEABLE, AND NON I/R, NET OR WITH EXCESS)

3.2 For tool inspection requirements of I/R tool coordination (applicable to new make, rework and coordination orders), Seller shall only utilize check pins which are AISI01 tool steel with a heat treat callout of RC 55-65 for pins with a diameter of .2500 or larger, and a RC 38-48 for pins with diameters smaller than .2500.

3.2.1 For Control Tool to Production Tool Coordination – Seller shall pin the control tool to the tool being coordinated with .0000 to .0005 undersize pins at four(4) locations reasonably close to the corners of the control tool. Seller shall inspect the remaining holes in accordance with pin tolerances shown in Table 2.0 for “Coordination Check of Control Tools”.

3.2.2 For Control Tool to Control Tool Coordination (Make New) – Seller shall install new control tool bushings utilizing pins with +.0000/-.0002 tolerance on diameter (Ref.: Transfer of hole pattern, Table 1.0).

3.2.3 For Control Tool to Control Tool Coordination (Rework) – During rework of control tools bushing, Seller shall install bushings utilizing pins with +.0000/-.0002 tolerance on diameter. (Ref.: Table 1.0, Transfer of hole pattern).

3.2.4 For Control Tool to Control Tool (Coordination Check Only) – Seller shall check the control tool back to the tool it was made from. During coordination checks of control tools, (Example: MSGA to TOGA), Seller shall pin four corner holes utilizing pins with +.0000/-.0002 undersize diameter. Ninety percent (90%) of the remaining holes are acceptable with .0000 to .0010 undersize diameter pins and the remaining ten percent (10%) of the holes are acceptable with +.0000/-.0025 undersize diameter pins.

3.2.5 For Cross-Coordination of Control Tools – When duplicate control tools are fabricated, Seller shall cross-coordinate control tools in accordance with Table 1.0 "Coordination Check of Control Tools" to ensure compatibility.

- 3.2.6 For Bushing Installation – During the manufacture of new tools and reworks, Seller shall utilize tooling pins with +.0000/-.0002 tolerance to install all tooling bushings (ref.: Table 1.0 and Table 2.0, Transfer of hole pattern).
- 3.2.7 For Inspection of Control Tool Bushing Wear – NOTE: During tool use activities, control tool bushing wear can occur. Seller shall inspect control tool bushings to ensure the maximum wear is limited in accordance with Table 1.0 and Table 2.0. Seller shall not use any control tools where bushing wear exceeds the maximum wear tolerance of +.0010 on the inside diameter.

Table 1.0 Coordination Check of Control Tools

HOLES UNDER .250	STRAIGHT PINS	HOLES .250 AND OVER
Nominal +.0001/+.0004 Nominal +.0000/-.0002	Transfer of Hole Pattern Bushing I.D. Tolerance Pin Tolerance	Nominal +.0001/+.0006 Nominal +.0000/-.0002
Nominal +.0001/+.0010 Nominal -.0015/-.0020	Cross Coordination / Coord. Check of Control Tools Bushing I.D. Tolerance Pin Tolerance	Nominal +.0001/+.0010 Nominal -.0020/-.0025
STEP PINS		
Nominal +.0001/+.0004 Nominal +.0000/-.0002 Nominal +.0000/-.0002 .0005 Max	Transfer of Hole Pattern (New Make) Bushing I.D. Tolerance Lg. Dia. Pin Tolerance Sm. Dia. Pin Tolerance Concentricity	Nominal +.0001/+.0006 Nominal +.0000/-.0002 Nominal +.0000/-.0002 .0005 Max
Nominal +.0001/+.0010 Nominal -.0000/-.0002 Nominal -.0015/-.0020	Cross Coordination / Coord. Check of Control Tools Bushing I.D. Tolerance Lg. Dia. Pin Tolerance Sm. Dia. Pin Tolerance	Nominal +.0001/+.0010 Nominal -.0000/-.0002 Nominal -.0020/-.0025

Table 2.0 Coordination Check of Production Tools

HOLES UNDER .250	STRAIGHT PINS	HOLES .250 AND OVER
Nominal +.0001/+.0004 Nominal +.0000/-.0002 Nominal +.0001/+.0004	Transfer of Hole Pattern (New Make) C/T Bushing I.D. Tolerance Pin Tolerance P/T Bushing I.D. Tolerance	Nominal +.0001/+.0006 Nominal +.0000/-.0002 Nominal +.0001/+.0006
Nominal +.0001/+.0010 Nominal -.0020/-.0025	Coordination Check of Control Tools to Prod. Tools Bushing I.D. Tolerance Pin Tolerance	Nominal +.0001/+.0010 Nominal -.0030/-.0035
	STEP PINS	
Nominal +.0001/+.0004 Nominal +.0001/+.0004 Nominal +.0000/-.0002 Nominal +.0000/-.0002 .0005 Max	Transfer of Hole Pattern (New Make) C/T Bushing I.D. Tolerance P/T Bushing I.D. Tolerance Lg. Dia. Pin Tolerance Sm. Dia. Pin Tolerance Concentricity	Nominal +.0001/+.0006 Nominal +.0000/-.0006 Nominal +.0000/-.0002 Nominal +.0000/-.0002 .0005 Max
Nominal +.0001/+.0010 Nominal +.0000/-.0002 Nominal -.0020/-.0025 .0005 Max	Coordination Check of Control Tools to Prod. Tools Bushing I.D. Tolerance Lg. Dia. Pin Tolerance Sm. Dia. Pin Tolerance Concentricity	Nominal +.0001/+.0010 Nominal +.0000/-.0002 Nominal -.0030/-.0035 .0005 Max
Nominal +.0000/-.0002 Nominal +.0001/+.0004 .0003	Additional Production Tool Tolerances O/D of Slip Bushing I/D of Slip Bushing Concentricity O/D to I/D	Nominal +.0000/-.0002 Nominal +.0001/+.0006 .0003
Nominal +.0000/-.0002 Nominal -.0010/-.0012 .0005 Max	Hinge Line Tool Tolerances Pins for End Hinges Pins for Middle Hinges Concentricity (end & middle)	Nominal +.0000/-.0002 Nominal -.0010/-.0012 .0005 Max

3.3 Seller shall utilize step pins, as illustrated in Table 3.0, to perform a verification check of production Items to production tools. Seller shall ensure the check-pin diameter is made to the low engineering range of the hole diameter being checked with the pin diameter tolerance as shown in Table 3.0.

Table 3.0 COORDINATION CHECK OF PRODUCTION TOOLS

HOLES UNDER .250	STEP PINS	HOLES .250 AND OVER
Nominal +.0001/+.0010 Nominal +.0000/-.0002 Nominal +.0000/-.0030 * .0005 Max	Coordination of Production Parts to Production Tools (Using Step Pins) P/T Bushing I/D Tolerance Lg. Dia. Pin in Tool Sm. Dia. Pin in Part Concentricity	Nominal +.0001/+.0010 Nominal +.0000/-.0002 Nominal +.0000/-.0030 .0005 Max

C/T - CONTROL TOOL	I/D - INSIDE DIAMETER
P/T - PRODUCTION TOOL	O/D - OUTSIDE DIAMETER

3.4 Seller shall verify I/R tooling tolerances are as follows:

- Master Tooling is net (nominal).
- Master Tooling to production tooling for trim and contour is +/- .005
- Production tool to production Item for edge and/or cutout trim is +/- .010, except replaceable edges, net or with excess, which is +/- .030, unless otherwise stated on the engineering drawings.
- Production tool to production Item tolerance for contour is .000 to +.020.

Note: This tolerance is a tooling application which recognizes the engineering drawing tolerance of +/- .010, unless otherwise specified, for sheet metal Item contour relative to Item being placed against a solid tool surface for checking. The tooling application also recognizes restraint in the tool, in accordance with the engineering drawing.

- Indenture tool development does not exceed +/- .005 total back to the master.
- Buyer-furnished Master Control Tooling is not used for production purposes, i.e., Item verification, trimming, drilling, and forming.

3.5 Seller shall verify non-I/R tooling perimeter, holes and contour tolerances are as follows:

- Non I-R Tooling Tools are net to engineering, unless otherwise identified, i.e., excess on a tooling sample.
- Tolerance from tooling tool to controlled production tooling is +/- .015" tolerance allowable over 80% of the gauging surface, and +/- .020" over 20% of the gauging surface as illustrated in Figure 6.0.

- Tolerance from controlled production tooling to production Item equals +/- the engineering drawing tolerance, for edge and/or cutout trim and holes.
- Controlled production tool to production Item tolerance for contour is .000 to +.020.

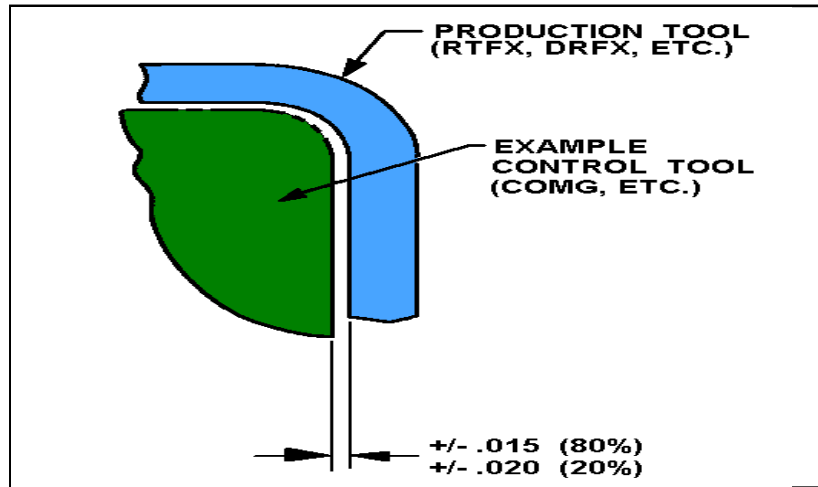
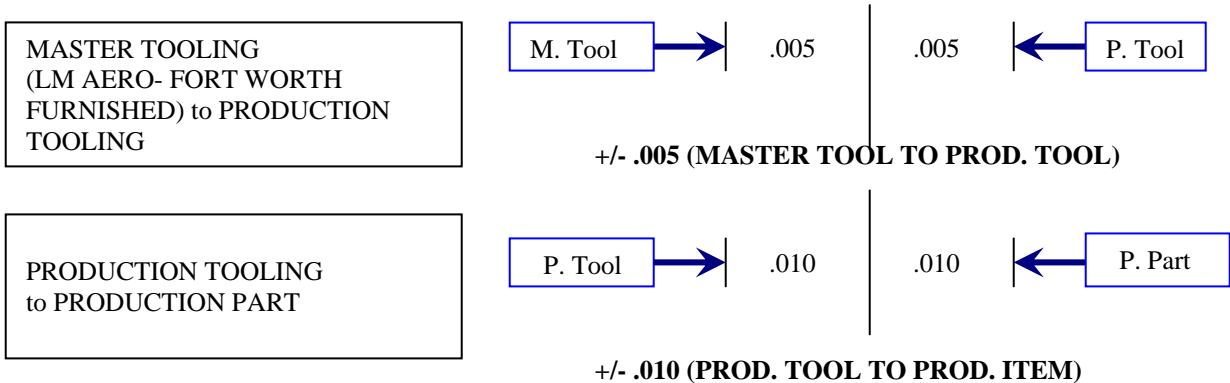

Figure 6. Production Tool to Control Tool

3.6 Seller shall verify Seller-developed tools yield an Item not to exceed +/- .010 variance from applicable Master Control Tooling.

3.7 Seller shall verify coordinated tool holes are direct pinning without undue interference.

3.8 I/R Tooling tolerance examples:



*****END OF APPENDIX A*****

*****END OF TMS-MC-015 MANUAL*****